

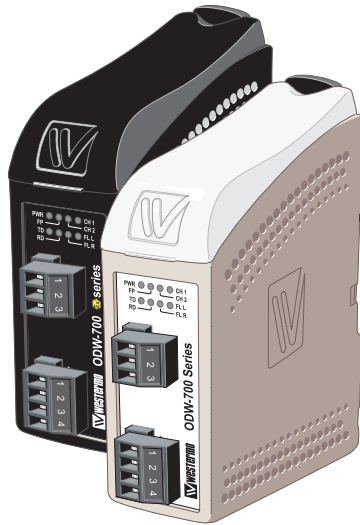

# ODW-730-F2

Fibre Optic Modem



**Industrial Converter**  
**RS-485 to Fibre Optic Link.**  
**Repeater, line and redundant ring**

## **Legal information**

The contents of this document are provided "as is". Except as required by applicable law, no warranties of any kind, either express or implied, including, but not limited to, the implied warranties of merchantability and fitness for a particular purpose, are made in relation to the accuracy and reliability or contents of this document. Westermo reserves the right to revise this document or withdraw it at any time without prior notice.

Under no circumstances shall Westermo be responsible for any loss of data or income or any special, incidental, and consequential or indirect damages howsoever caused.

More information about Westermo can be found at the following Internet address:  
**<http://www.westermo.com>**

## Safety



### **Before installation:**

Read this manual completely and gather all information on the unit. Make sure that you understand it fully. Check that your application does not exceed the safe operating specifications for this unit.

This unit should only be installed by qualified personnel.

This unit should be built-in to an apparatus cabinet, or similar, where access is restricted to service personnel only.

The power supply wiring must be sufficiently fused, and if necessary it must be possible to disconnect manually from the power supply. Ensure compliance to national installation regulations.

Branch circuit protection (fuse) is required for this unit with rating not exceeding 20 A.

Product should be connected to UL Listed power supplies rated 12 – 48VDC, min 500 mA or 24 VAC, min 500 mA or reliably grounded DC SELV source\*.



This unit uses convection cooling. To avoid obstructing the airflow around the unit, follow the spacing recommendations (see Cooling section).

### **Before mounting, using or removing this unit:**

Prevent access to hazardous voltages by disconnecting the unit from the power supply.



Warning! Do not open a connected unit. Hazardous voltages may occur within this unit when connected to a power supply.

### **Class 1 Laser Product**

This unit is designed to meet the Class 1 Laser regulations. However, the user is warned not to look directly into fibre optical fibre port or any connected fibre.

### **Care recommendations**

Follow the care recommendations below to maintain full operation of the unit and to fulfil the warranty obligations.

This unit must not be operated with covers or lids removed.

Do not attempt to disassemble the unit. There are no user serviceable parts inside.

Do not drop, knock or shake the unit. Rough handling beyond the specification may cause damage to internal circuit boards.

Do not use harsh chemicals, cleaning solvents or strong detergents to clean the unit.

Do not paint the unit. Paint can clog the unit and prevent proper operation.

Do not expose the unit to any kind of liquids (rain, beverages, etc).

The unit is not waterproof. Keep the unit within the specified humidity levels.

Do not use or store the unit in dusty, dirty areas. Connectors as well as other mechanical parts may be damaged.

If the unit is not working properly, contact the place of purchase, nearest Westermo distributor office, or Westermo Tech support.

Fibre connectors are supplied with plugs to avoid contamination inside the optical port.

The plug should be fitted when no optical fibre is inserted in the connector, e.g. during storage, service or transportation.

\* Applicable for ODW-730-F2 only

## Note. Fibre Optic Handling

Fibre optic equipment requires careful handling as the fibre components are very sensitive to dust and dirt. If the fibre is disconnected from the modem, the protective plug on the transmitter/receiver must be replaced. The protective plug must be kept on during transportation. The fibre optic cable must also be protected in the same way.

If this recommendation is not followed, it can jeopardise the warranty.

## Cleaning of the optical connectors

In the event of contamination, the optical connectors should be cleaned by using forced nitrogen and some kind of cleaning stick.

Recommended cleaning fluids:

- Methyl-, ethyl-, isopropyl- or isobutyl-alcohol
- Hexane
- Naphtha

## Maintenance

No maintenance is required, as long as the unit is used as intended within the specified conditions.

## Agency approvals and standards compliance

| Type   | Approval / Compliance  |
|--------|--|
| EMC    | EN 61000-6-1, Immunity residential environments                  |
|        | EN 61000-6-2, Immunity industrial environments                   |
|        | EN 61000-6-3, Emission residential environments                  |
|        | EN 61000-6-4, Emission industrial environments                   |
|        | EN 55022, Emission IT equipment, class A                         |
|        | EN 55024, Immunity IT equipment                                  |
|        | FCC part 15 Class A  |
|        | EN 50121-4, Railway signalling and telecommunications apparatus  |
|        | IEC 62236-4, Railway signalling and telecommunications apparatus |
| Safety | UL/CSA/IEC/EN 60950-1, IT equipment*                             |
|        | EN 60950-1, IT equipment**                                       |
| ATEX** | EN 60079-0 and EN 60079-15                                       |

\* Applicable for ODW-730-F2 only

\*\* Applicable for ODW-730-F2 Ex only

### FCC Part 15.105

#### Notice:

This equipment has been tested and found to comply with the limits for a Class A digital device, pursuant to Part 15 of the FCC Rules. These limits are designed to provide reasonable protection against harmful interference when the equipment is operated in a commercial environment.

This equipment generates, uses, and can radiate radio frequency energy and, if not installed and used in accordance with the instruction manual, may cause harmful interference to radio communications. Operation of this equipment in a residential area is likely to cause harmful interference in which case the user will be required to correct the interference at his own expense.

### EN 55022 Notice:

This is a class A product. In a domestic environment this product may cause radio interference in which case the user may be required to take adequate measures.



## ATEX Information (Applicable for ODW-730-F2 Ex only)

### General

This unit is intended for use in Zone 2 hazardous location only.

### Marking

II 3 G

Ex nA IIC T4 Gc

SPECIAL CONDITION

WARNING – DO NOT SEPARATE WHEN ENERGIZED

|                          |  |
|--------------------------|--|
|                          | Indicate that this unit complies with relevant European standards that are harmonised with the 94/9/EC Directive (ATEX).   |
| <b>II</b>                | Equipment group II.<br>This unit can be installed in all places with an explosive gas atmosphere other than mines susceptible to firedamp  |
| <b>3</b>                 | Equipment category 3.<br>A category is the classification according to the required level of protection. This unit ensures the requisite level of protection during normal operation and is intended for use in areas in which explosive atmosphere caused by gases, vapours, mists, or dust mixtures are unlikely to occur or, if they do occur, are likely to do so only infrequently and for a short period only. |
| <b>G</b>                 | Indicates protection concerning explosive atmospheres caused by gases, vapours or mists (G).   |
| <b>Ex</b>                | Indicates that this unit is in conformity with relevant European Ex standard(s).   |
| <b>nA</b>                | Type of protection used.<br>This unit is a non-sparking device "nA" which is constructed to minimize the risk of occurrence of arcs or sparks capable of creating an ignition hazard during conditions of normal operation.  |
| <b>IIC</b>               | Gas group, a typical gas i hydrogen.   |
| <b>T4</b>                | Temperature class T4 (T4 = 135°C).<br>This unit is classified in accordance with its maximum surface temperature (external and internal).  |
| <b>Gc</b>                | Equipment protection level Gc (EPL Gc).<br>Equipment for explosive gas atmospheres, having a "enhanced" level of protection, which is not a source of ignition in normal operation and which may have some additional protection to ensure that it remains inactive as an ignition source in the case of regular expected occurrences. EPL Gc are analogous to the ATEX Categories (Category 3 G = EPL Gc).          |
| <b>SPECIAL CONDITION</b> | This unit has a special condition of use.<br>The special condition for safe use contains safety related information that is necessary for the correct installation and safe use.   |

## Ratings

|                                   |   |
|-----------------------------------|---|
| <b>Power</b>                      | (12 – 48) VDC; 400 mA                                   |
| <b>Ambient temperature</b>        | $-40^{\circ}\text{C} \leq T_a \leq +60^{\circ}\text{C}$ |
| <b>Ingress protection (IP)</b>    | IP21  |
| <b>Maximum surface temperatur</b> | 135°C (temperature class T4)                            |

## Safety Control Drawing

|                             |   |
|-----------------------------|---|
| <b>Degree of protection</b> | IP 21   |
| <b>Ambient temperature</b>  | $-40^{\circ}\text{C}$ to $+60^{\circ}\text{C}$            |
| <b>Installation spacing</b> | Minimum 25 mm above / below<br>Minimum 10 mm left / right |

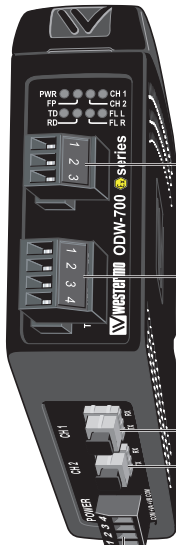

| Position | Descripton                    | Input / Output values                                       |
|----------|-------------------------------|---|
| 1        | In & out / Relay contact (NO) | $U_{in} = 60\text{VDC max}$<br>$I_{in} = 500\text{ mA max}$ |
| 2        | In & out / Relay contact (C)  |   |
| 3        | In & out / Relay contact (NC) |   |

Galvanically isolated via mechanical relay.  
See user manual for proven transient protection.

| Position | Descripton                 | Input / Output values  |
|----------|----------------------------|--|
| 1        | In+ (EIA RS-485 A)         | $U_{max} = \pm 5\text{Vpk}$<br>$I_{max} = \pm 250\text{ mA}$ |
| 2        | In / R- (EIA RS-485 B)     |  |
| 3        | In/out / T+ (EIA RS-485 A) | Data rate:   |
| 4        | In/out / T- (EIA RS-485 B) | 300 bit/s to 1.5 Mbit/s                                      |

| Position | Descripton          | Output values |
|----------|---------------------|---------------|
| Rx       | In / Receive port   | Max 0 dBm     |
| Tx       | Out / Transmit port |               |

| Position | Descripton      | Intput values   |  |
|----------|-----------------|---|--|
| 1        | In / Common     | $U_{in} = (10 - 60)\text{VDC}$<br>$I_{in} = 550\text{ mA max}$<br>$P_{in} = \text{Max } 5.5\text{ W}$ |  |
| 2        | In / +Voltage A |   |  |
| 3        | In / +Voltage B |   |  |
| 4        | In / Common     |   |  |

See section *Type tests and environmental conditions* in this user manual for proven transient protection.

## **SPECIAL CONDITION FOR SAFE USE**

### **Ambient temperature:**

This unit is designed for use in extreme ambient temperature conditions as follows:  
 $-40\text{ °C} \leq T_a \leq +60\text{ °C}$

### **Installation in an apparatus cabinet:**

This unit requires installation in an Ex certified apparatus cabinet suitable for the area of use and providing a degree of protection of at least IP54.

### **Resistance to impact:**

This unit requires installation in an apparatus cabinet where adequate resistance to impact is provided by the apparatus cabinet. See "Installation in an apparatus cabinet" above for requirements on the external apparatus cabinet.

### **Resistance to light:**

This unit requires installation in an apparatus cabinet where it is protected from light (for example daylight or light from luminaires).

See "Installation in an apparatus cabinet" above for requirements on the external apparatus cabinet.

### **Secureness of plugs:**

When this unit is installed in an explosive atmospheres, all connectors must be mechanically secured to prevent loosening.

### **Conductor temperature:**

When this unit is installed in locations with high ambient temperature, special precautions shall be taken upon the choice of external conductors and the temperature rating of the conductor(s).

### **Directive 94/9/EC alongside with other directives:**

Directive 2004/108/EC (EMC) applies and to assure a safe performance of this unit under the scope of Directive 94/9/EC, refer to the electromagnetic immunity level specified under "Type tests and environmental conditions" in this manual.

### **Standards and date of compliance**

EN 60079-0 and EN 60079-15  
2010-12-17

# Declaration of Conformity



Westermo Teleindustri AB

## Declaration of conformity

The manufacturer      Westermo Teleindustri AB  
SE-640 40 Stora Sundby, Sweden

Herewith declares that the product(s)

| Type of product                                  | Model            | Art no    |
|--|------------------|-----------|
| Industrial fiberoptic repeaters/media converters | ODW-700 series   | 3651-07xx |
|  | ODW-700EX series | 3651-37xx |

is in conformity with the following EC directive(s).

| No                   | Short name                             |
|----------------------|--|
| 2004/108/EC          | Electromagnetic Compatibility (EMC)    |
| 94/9/EC <sup>1</sup> | Equipment Explosive Atmospheres (ATEX) |

References of standards applied for this EC declaration of conformity.

| No           | Title  | Issue                    |
|--------------|--|--------------------------|
| EN 61000-6-1 | Electromagnetic compatibility – Immunity residential environments  | 2007                     |
| EN 61000-6-2 | Electromagnetic compatibility – Immunity industrial environments   | 2005                     |
| EN 61000-6-3 | Electromagnetic compatibility – Emission residential environments  | 2007                     |
| EN 61000-6-4 | Electromagnetic compatibility – Emission for industrial environments   | 2007                     |
| EN 55022     | Information technology equipment - Emission  | 2006 + A1:2007           |
| EN 55024     | Information technology equipment - Immunity  | 1998 + A1:2001 + A2:2003 |
| EN 50121-4   | Railway applications – Electromagnetic compatibility – Emission and immunity of the signalling and telecommunications apparatus    | 2006                     |
| EN 60079-0   | Explosive atmospheres – Equipment – General requirements   | 2009                     |
| EN 60079-15  | Electrical apparatus for explosive gas atmospheres – Construction, test and marking of type of protection “n” electrical apparatus | 2005                     |

The last two digits of the year in which the CE marking was affixed:      11

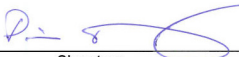
  
Signature

Pierre Öberg  
Technical Manager  
15th June 2011

<sup>1</sup> Applicable for ODW-700EX series only.

|                                 |                               |                               |            |           |                                  |                   |
|---------------------------------|-------------------------------|-------------------------------|------------|-----------|----------------------------------|-------------------|
| Postadress/Postal address       | Tel.                          | Telefax                       | Postgiro   | Bankgiro  | Org.nr/<br>Corp. identity number | Registered office |
| S-640 40 Stora Sundby<br>Sweden | 016-428000<br>Int+46 16428000 | 016-428001<br>Int+46 16428001 | 52 72 79-4 | 5671-5550 | 556361-2604                      | Eskestuna         |



## Type tests and environmental conditions

| Electromagnetic Compatibility |                |   |  |
|-------------------------------|----------------|---|--|
| Phenomena                     | Test           | Description                             | Level  |
| ESD                           | EN 61000-4-2   | Enclosure contact                       | ± 6 kV   |
|                               |                | Enclosure air                           | ± 8 kV   |
| RF field AM modulated         | IEC 61000-4-3  | Enclosure                               | 10 V/m 80% AM (1 kHz), 80 – 800 MHz<br>20 V/m 80% AM (1 kHz), 800 – 1000 MHz<br>20 V/m 80% AM (1 kHz), 1400 – 2700 MHz |
| RF field 900 MHz              | ENV 50204      | Enclosure                               | 20 V/m pulse modulated 200 Hz, 900 ± 5 MHz   |
| Fast transient                | EN 61000-4-4   | Signal ports                            | ± 2 kV   |
|                               |                | Power ports                             | ± 2 kV   |
| Surge                         | EN 61000-4-5   | Signal ports unbalanced                 | ± 2 kV line to earth, ± 2 kV line to line  |
|                               |                | Signal ports balanced                   | ± 2 kV line to earth, ± 1 kV line to line  |
|                               |                | Power ports                             | ± 2 kV line to earth, ± 2 kV line to line  |
| RF conducted                  | EN 61000-4-6   | Signal ports                            | 10 V 80% AM (1 kHz), 0.15 – 80 MHz   |
|                               |                | Power ports                             | 10 V 80% AM (1 kHz), 0.15 – 80 MHz   |
| Pulse Magnetic field          | EN 61000-4-9   | Enclosure                               | 300 A/m, 6.4 / 16 µs pulse   |
| Voltage dips and interruption | EN 61000-4-11  | AC power ports                          | 10 & 5 000 ms, interruption<br>200 ms, 40% residual voltage<br>500 ms, 70% residual voltage                            |
| Mains freq. 50 Hz             | EN 61000-4-16  | Signal ports                            | 100 V 50 Hz line to earth  |
| Mains freq. 50 Hz             | SS 436 15 03   | Signal ports                            | 250 V 50 Hz line to line   |
| Radiated emission             | EN 55022       | Enclosure                               | Class B  |
|                               | FCC part 15    |   | Class A  |
| Conducted emission            | EN 55022       | AC power ports                          | Class B  |
|                               | FCC part 15    | AC power ports                          | Class B  |
|                               | EN 55022       | DC power ports                          | Class A  |
| Dielectric strength           | EN 60950       | Signal port to all other isolated ports | 2 kVrms 50 Hz 1min   |
|                               |                | Power port to other isolated ports      | 3 kVrms 50 Hz 1min<br>2 kVrms 50 Hz 1min (@ rated power < 60V)   |
| Environmental                 |                |   |  |
| Temperature                   |                | Operating                               | -40 to +60°C   |
|                               |                | Storage & Transport                     | -40 to +70°C   |
|                               |                | Maximum surface temperature             | 135°C (temperature class T4)   |
| Humidity                      |                | Operating                               | 5 to 95% relative humidity   |
|                               |                | Storage & Transport                     | 5 to 95% relative humidity   |
| Altitude                      |                | Operating                               | 2 000 m / 70 kPa   |
| Service life                  |                | Operating                               | 10 year  |
| Vibration                     | IEC 60068-2-6  | Operating                               | 7.5 mm, 5 – 8 Hz<br>2 g, 8 – 500 Hz  |
| Shock                         | IEC 60068-2-27 | Operating                               | 15 g, 11 ms  |
| Packaging                     |                |   |  |
| Enclosure, ODW-730-F2         | UL 94          | PC / ABS                                | Flammability class V-1   |
| Enclosure, ODW-730-F2 EX      |                | Cabelec 6141                            |  |
| Dimension W x H x D           |                |   | 35 x 121 x 119 mm  |
| Weight                        |                |   | 0.26 kg  |
| Degree of protection          |                |   | IP 21  |
| Cooling                       | IEC 529        | Enclosure                               | Convection   |
| Mounting                      |                |   | Horizontal on 35 mm DIN-rail   |

# Functional description

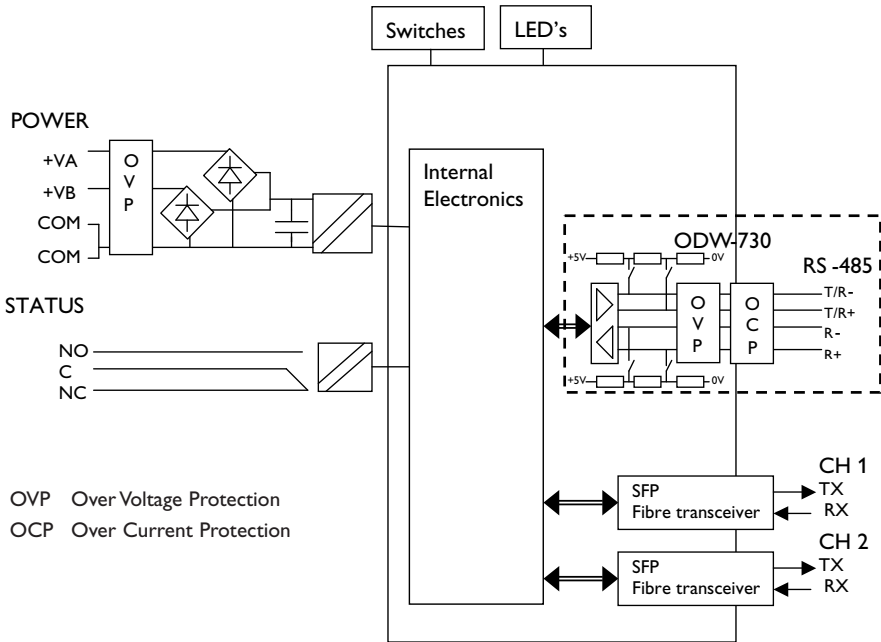

## Converter serial interface – optical fibre

ODW-730 is a fibre optic modem that converts between electrical RS-485 and a fibre optical link.

ODW-730 can also be used to convert from RS-485 to RS-232 by using a ODW-730 in the same link as ODW-720.

## Repeater – optical fibre links

ODW-730 is a fibre optic repeater that repeats received data from one fibre link out to the other link. This is useful e.g. for long distance communication, where electromagnetic interference may occur or when isolation of the electrical network is needed. The maximum optical fibre distance depends on selected fibre transceiver and fibre type. Distances up to 80 km (50 miles) are available.

## Interface specifications

| Power                           |   |
|---------------------------------|---|
| Rated voltage                   | ODW-730-F2: 12 to 48 VDC and 24 VAC<br>ODW-730-F2 Ex: 12 to 48 VDC  |
| Operating voltage               | ODW-730-F2: 10 to 60 VDC and 20 to 30 VAC<br>ODW-730-F2 Ex: 10 to 60 VDC  |
| Rated current                   | 400 mA @ 12 V<br>200 mA @ 24 V<br>100 mA @ 48 V   |
| Rated frequency                 | ODW-730-F2: DC and 48 to 62 Hz<br>ODW-730-F2 Ex: DC   |
| Inrush current I <sup>2</sup> t | 0.2 A <sup>2</sup> s  |
| Startup current*                | 1.0 A <sub>peak</sub>   |
| Polarity                        | Reverse polarity protected  |
| Redundant power input           | Yes   |
| Isolation to                    | RS-485 and Status port  |
| Connection                      | Detachable screw terminal   |
| Connector size                  | 0.75 – 2.5 mm <sup>2</sup> (AWG 18 – 13)<br>Connect the unit using at least 18 AWG (0.75 mm <sup>2</sup> ) wiring |
| Shielded cable                  | Not required  |

\* External supply current capability for proper startup

| Status             |   |
|--------------------|---|
| Port type          | Signal relay, changeover contacts       |
| Rated voltage      | Up to 48 VDC                            |
| Operating voltage  | Up to 60 VDC                            |
| Contact rating     | 500 mA @ 48 VDC                         |
| Contact resistance | < 50 mΩ                                 |
| Isolation to       | RS-485 and Power port                   |
| Connection         | Detachable screw terminal               |
| Connector size     | 0.2 – 2.5 mm <sup>2</sup> (AWG 24 – 13) |
| Shielded cable     | Not required                            |

| <b>RS-422/485</b>               |  |
|---------------------------------|--|
| Electrical specification        | EIA RS-485, 2-wire or 4-wire twisted pair  |
| Data rate                       | 300 bit/s – 1.5 Mbit/s   |
| Data format                     | 9 – 12 bits  |
| Protocol                        | Start-bit followed by 8-11 bits  |
| Retiming                        | Yes  |
| Turning time<br>(2-wire RS-485) | One $t_{\text{bit}}$<br>$t_{\text{bit}} = 1 / \text{Baud rate}$ (Baud rate in bit/s) |
| Transmission range              | < 1200 m, depending on data rate and cable type (EIA RS-485)                         |
| Settings                        | 120 $\Omega$ termination and failsafe biasing 680 $\Omega$                           |
| Protection                      | Installation Fault Tolerant (up to $\pm 60$ V)                                       |
| Isolation to                    | Status and Power port  |
| Connection                      | Detachable screw terminal  |
| Connector size                  | 0.2 – 2.5 mm <sup>2</sup> (AWG 24 – 13)  |
| Shielded cable                  | Not required   |

### Optical Power Budget

The allowed link length is calculated from the optical power budget (OPB), the available optical power for a fibre-optic link, and the attenuation of the fibre, comprising losses due to in-line connectors, splices, optical switches and a margin for link ageing (typical 1.5 dB for 1300 nm).

The worst-case optical power budget (OPB) in dB for a fibre-optic link is determined by the difference between the transmitter's output optical power (min) and the receiver input sensitivity (max).

| <b>FX (Fibre)</b>                           | <b>SM-LC80</b>  | <b>SM-LC40</b>                    | <b>SM-LC20</b>                    | <b>MM-LC2</b>                        |
|---|---|-----------------------------------|-----------------------------------|--------------------------------------|
| Fibre connector                             | LC duplex   | LC duplex                         | LC duplex                         | LC duplex                            |
| Fibre type                                  | Singlemode<br>9/125 $\mu\text{m}$   | Singlemode<br>9/125 $\mu\text{m}$ | Singlemode<br>9/125 $\mu\text{m}$ | Multimode,<br>62.5/125 $\mu\text{m}$ |
| Wavelength                                  | 1550 nm   | 1310 nm                           | 1310 nm                           | 1310 nm                              |
| Transmitter<br>Output optical power min/max | -5/0 dBm  | -5/0 dBm                          | -15/-8 dBm                        | -20/-14<br>dBm                       |
| Receiver<br>Input sensitivity, max          | -35 dBm   | -35 dBm                           | -34 dBm                           | -31 dBm                              |
| Receiver<br>Input optical power, max        | 0 dBm   | 0 dBm                             | 0 dBm                             | -8 dBm                               |
| Optical power budget,<br>worst-case         | 30 dB   | 30 dB                             | 19 dB                             | 11 dB                                |
| Transceiver type                            | Small Form Factor Pluggable (SFP)<br>Multi-Sourcing Agreement (MSA) compliant |                                   |                                   |                                      |
| Laser class                                 | Class 1, IEC 825-1 Accessible Emission Limit (AEL)                            |                                   |                                   |                                      |

| <b>FX (Fibre)</b>  | <b>Bi-Di LC-40</b>  | <b>Bi-Di LC-20</b>                  |
|--|---|-------------------------------------|
| Fibre connector  | LC Simplex  | LC Simplex                          |
| Fibre type   | Singlemode<br>9/125 $\mu\text{m}$   | Singlemode<br>9/125 $\mu\text{m}$   |
| Wavelength nm, connector 1<br>Wavelength nm, connector 2 | Tx 1310, Rx 1550<br>Tx 1550, Rx 1310  | Tx1310, Rx 1550<br>Tx 1550, Rx 1310 |
| Transmitter<br>Output optical power min/max              | -8/0 dBm  | -14/8 dBm                           |
| Receiver<br>Input sensitivity, max                       | -34 dBm   | -32 dBm                             |
| Receiver<br>Input optical power, max                     | -3 dBm  | 0 dBm                               |
| Optical power budget,<br>worst-case                      | 26 dB   | 18 dB                               |
| Bit error rate (BER)                                     | $< 1 \times 10^{-10}$   | $< 1 \times 10^{-10}$               |
| Transceiver type   | Small Form Factor Pluggable (SFP)<br>Multi-Sourcing Agreement (MSA) compliant |                                     |
| Laser class  | Class 1, IEC 825-1 Accessible Emission Limit (AEL)                            |                                     |

# Location of Interface ports, LED's and DIP-switches

## ODW-730-F2

LED Indicators(for details see page 15)

DIP-switches accessible under lid  
(for details see page 16–18)

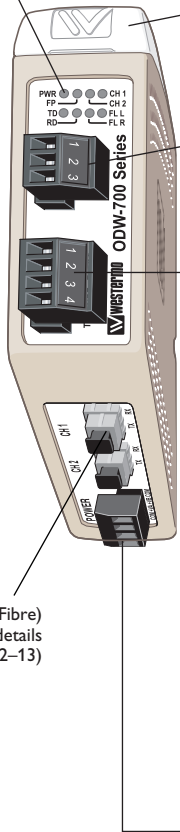

FX(Fibre)  
(for details  
see page 12–13)

### Status screw terminal

| Position | Description  | Product marking |
|----------|--|-----------------|
| 1        | Contact with C when fibre optical links are in operation               | NO              |
| 2        | Common   | C               |
| 3        | Open (no contact with C) when fibre optical links are not in operation | NC              |

### RS-422/485 screw terminal

| Position | Direction* | Description        | Product marking |
|----------|------------|--------------------|-----------------|
| 1        | In         | R+ (EIA RS-485 A') | R+              |
| 2        | In         | R- (EIA RS-485 B') | R-              |
| 3        | In/Out     | T+ (EIA RS-485 A)  | T/R+            |
| 4        | In/Out     | T- (EIA RS-485 B)  | T/R-            |

### Power screw terminal

| Position | Direction* | Description    | Product marking |
|----------|------------|----------------|-----------------|
| 1        | In         | Common voltage | COM             |
| 2        | In         | Voltage A      | +VA             |
| 3        | In         | Voltage B      | +VB             |
| 4        | In         | Common voltage | COM             |

\* Direction relative this unit

## LED indicators

| LED                           | Status   | Description   |
|-------------------------------|----------|---|
| PWR<br>Power                  | ON       | Power is on.  |
|                               | OFF      | Power is off.   |
| FP                            | ON       | Focal point   |
|                               | OFF      | Redundant ring member or multidrop unit.  |
| CH 2<br>Channel 2 link status | ON       | Fiber link to other unit has been established at CH 2.  |
|                               | Flashing | Optical power detected but link to other unit has not been established at CH 2.                 |
|                               | OFF      | No optical power detected and no link to other unit has been established at CH 2.               |
| CH 1<br>Channel 1 link status | ON       | Fiber link to other unit has been established at CH 1.  |
|                               | Flashing | Optical power detected but link to other unit has not been established at CH 1.                 |
|                               | OFF      | No optical power detected and no link to other unit has been established at CH 1.               |
| TD                            | Flash    | Data received on the electrical interface and transmitted out on the optical interface.         |
|                               | OFF      | No data received on the electrical interface.   |
| RD                            | Flash    | Data received on the optical interface and transmitted out on the electrical interface.         |
|                               | OFF      | No data received on the optical interface.  |
| FL R<br>Failure link remote   | ON       | Remote fibre link failure.<br>A fibre link is out of operation at any other unit than this one. |
|                               | Flashing | Hardware error or invalid configuration.  |
| FL L<br>Failure link local    | ON       | Local fibre link failure.<br>A fibre link is out of operation at this unit.                     |
|                               | Flashing | Hardware error or invalid configuration.  |

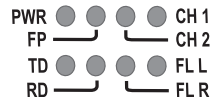

**Note:** During power up, all LED's will turn on for about 1 second.

## DIP-switch settings







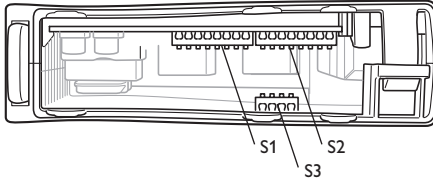













### Before DIP-switch settings:

Prevent damage to internal electronics from electrostatic discharges (ESD) by discharging your body to a grounding point (e.g. use of wrist strap)

**Note:** Disconnect power before DIP-switch settings.



### S1 DIP-switch, asynchronous mode speed selection

|   |  |   |
|---|--|---|
|  300 bit/s     |  57.6 kbit/s  |  1.0 Mbit/s            |
|  1200 bit/s    |  115.2 kbit/s |  1.5 Mbit/s            |
|  2400 bit/s    |  125 kbit/s   |  9 bits data format    |
|  4800 bit/s    |  187.5 kbit/s |  10 bits data format   |
|  9600 bit/s    |  230.4 kbit/s |  11 bits data format   |
|  19.2 kbit/s |  250 kbit/s |  12 bits data format |
|  38.4 kbit/s |  500 kbit/s |   |

Supervision table when selecting data format

|               |   |    |    |    |    |    |    |    |
|---------------|---|----|----|----|----|----|----|----|
| Start bit     | ☐ | ☐  | ☐  | ☐  | ☐  | ☐  | ☐  | ☐  |
| 7 bit         | ☐ | ☐  | ☐  | ☐  | ☐  | ☐  | ☐  | ☐  |
| 8 bit         | ☐ | ☐  | ☐  | ☐  | ☐  | ☐  | ☐  | ☐  |
| Parity        | ☐ | ☐  | ☐  | ☐  | ☐  | ☐  | ☐  | ☐  |
| 1 stop bit    | ☐ | ☐  | ☐  | ☐  | ☐  | ☐  | ☐  | ☐  |
| 2 stop bit    | ☐ | ☐  | ☐  | ☐  | ☐  | ☐  | ☐  | ☐  |
| Number of bit | 9 | 10 | 10 | 10 | 11 | 11 | 11 | 12 |



## S1 DIP-switch, synchronous mode time frame selection

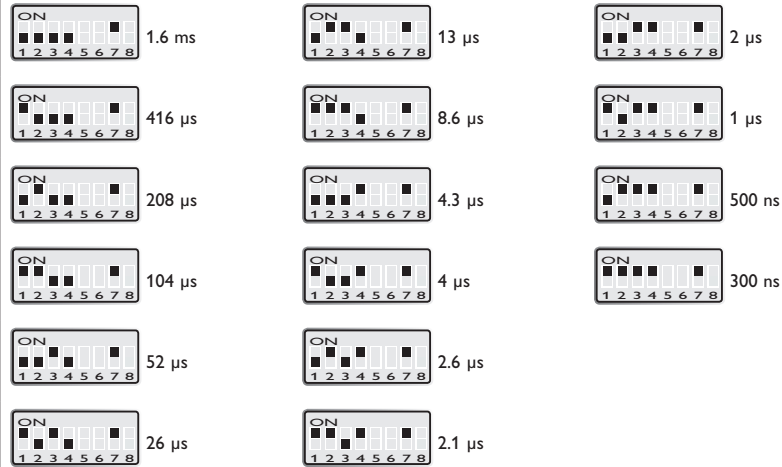

## S1 DIP-switch / Description V/Y mode

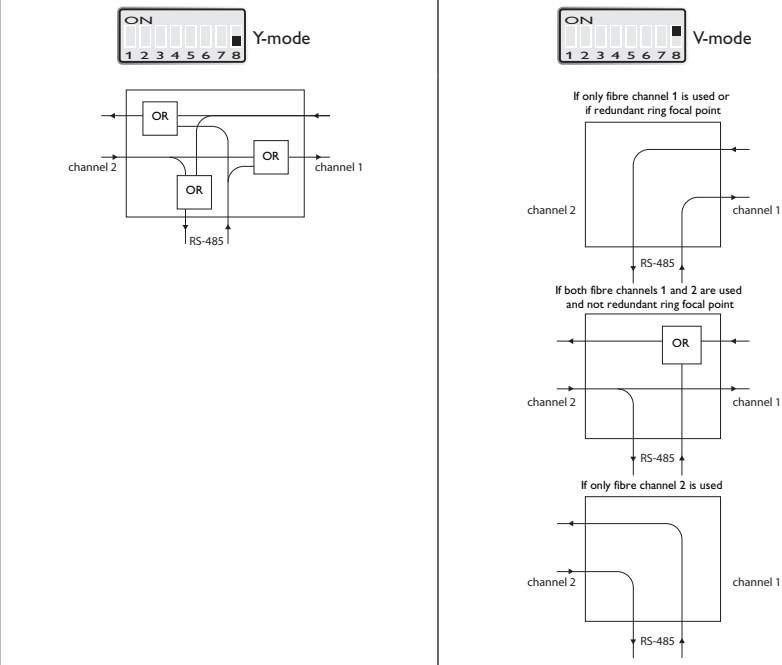

For applications that only require half duplex communication it is recommended to use Y-mode. Please see the ODW-730 Management Guide for further details.

## S2 DIP-switch



RS-485  
2-wire



Use secondary data channel.



RS-485  
4-wire

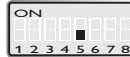

Single channel system redundant ring. E.g. only the primary or secondary channel is used.



Multidrop mode.

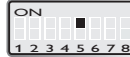

Dual channel system redundant ring. E.g. both the primary and secondary channel are used simultaneously.



Redundant ring mode.



Set status port on both local fibre link (FL L) and remote fibre link (FL R) errors.



Multidrop mid unit or Redundant ring member.



Set status port on local fibre link (FL L) error only.



Multidrop end unit. Redundant ring focal point.



S2:7 has no function



Use primary data channel.



Always OFF

## S3 DIP-switch



No termination and fail-safe



Termination with fail-safe (2-wire)



Termination with fail-safe (4-wire)

## Factory default



S1



S2

### RS-485 termination at system level

The system should be installed in according to the RS-485 specification. A system should always form a bus structure where the termination is at the end points of the bus. See diagrams for details of how this is done with RS-485 2-wire and 4-wire.

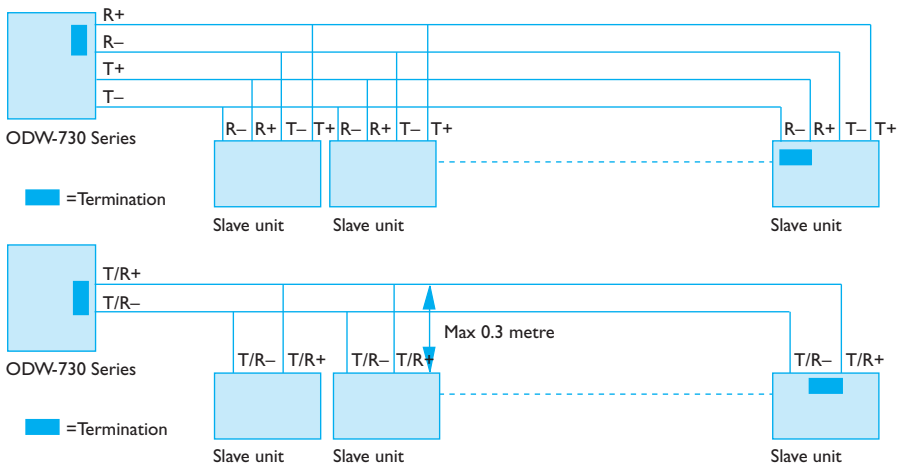

**N.B.** R+/R-, T+/T- definitions are not standard, it can help to shift + and - if the unit does not work.

## About the interfaces

### Power terminal

The power terminal has two independent inputs, +VA and +VB, allowing redundancy should either fail. The ODW-730 power supply is galvanically isolated from all other internal electronics.

### Optical fibre interfaces

ODW-730 uses Small Form Factor Pluggable (SFP) transceivers that are in compliance with the Multi-Sourcing Agreement (MSA). This means that a wide range of different fibre transceivers and connectors can be used.

### RS-485 interface

A 4 position detachable screw terminal that can handle full duplex data rates up to 1.5 Mbit/s and can be set to either 2- or 4-wire RS-485 system.

When 4-wire RS-485 is selected, the terminals T/R+ and T/R- will always be set to transmit and terminals R+ and R- will always receive data.

Manchester coded protocol can be transferred with Synchronous mode.

### Status port

The status port connects to an internal relay which may be used to trigger an external alarm if a fault condition occurs. During normal operation pins 1 and 2 are in contact with each other, and pins 2 and 3 are isolated. During an optical link failure, or power failure, pins 1 and 2 are isolated, and pins 2 and 3 are in contact with each other.

Optical link failures can be classified into two categories, local or remote, as indicated by the FL L and FL R LED's. A local link failure is when an optical link is down at this particular unit. A remote link failure is when an optical link is down at some other unit.

From the factory, the status port is set to trigger on both types of link failures.

However, by setting DIP-switch S2:6 to the ON position, the status port will only trigger when a local link failure has occurred.

## Mounting

This unit should be mounted on 35 mm DIN-rail, which is horizontally mounted inside an apparatus cabinet, or similar. Snap on mounting, see figure.

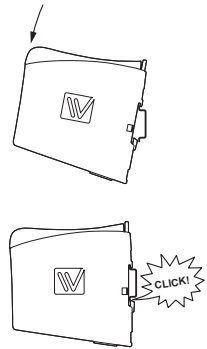

## Cooling

This unit uses convection cooling. To avoid obstructing the air-flow around the unit, use the following spacing rules. Minimum spacing 25 mm (1.0 inch) above /below and 10 mm (0.4 inches) left /right the unit. Spacing is recommended for the use of unit in full operating temperature range and service life.

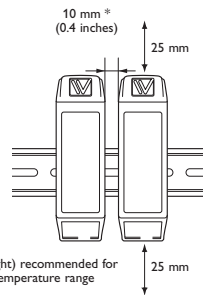

## Removal

Press down the black support at the top of the unit. See figure.

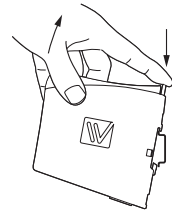

## Referring documents

For detailed information on how to configure the ODW-730-F2 for different applications.

| <b>Type</b>      | <b>Description</b>          | <b>Document number</b> |
|------------------|-----------------------------|------------------------|
| Management Guide | Management Guide ODW-730-F2 | 6651-2255              |





Westermo • SE-640 40 Stora Sundby, Sweden  
Tel +46 16 42 80 00 Fax +46 16 42 80 01  
E-mail: [info@westermo.com](mailto:info@westermo.com)  
[www.westermo.com](http://www.westermo.com)

## Sales Units

### Westermo Data Communications

---

#### China

[sales.cn@westermo.com](mailto:sales.cn@westermo.com)  
[www.cn.westermo.com](http://www.cn.westermo.com)

#### France

[infos@westermo.fr](mailto:infos@westermo.fr)  
[www.westermo.fr](http://www.westermo.fr)

#### Germany

[info@westermo.de](mailto:info@westermo.de)  
[www.westermo.de](http://www.westermo.de)

#### North America

[info@westermo.com](mailto:info@westermo.com)  
[www.westermo.com](http://www.westermo.com)

#### Singapore

[sales@westermo.com.sg](mailto:sales@westermo.com.sg)  
[www.westermo.com](http://www.westermo.com)

#### Sweden

[info.sverige@westermo.se](mailto:info.sverige@westermo.se)  
[www.westermo.se](http://www.westermo.se)

#### United Kingdom

[sales@westermo.co.uk](mailto:sales@westermo.co.uk)  
[www.westermo.co.uk](http://www.westermo.co.uk)

#### Other Offices



*For complete contact information, please visit our website at [www.westermo.com/contact](http://www.westermo.com/contact) or scan the QR code with your mobile phone.*