

User Guide
6651-2211

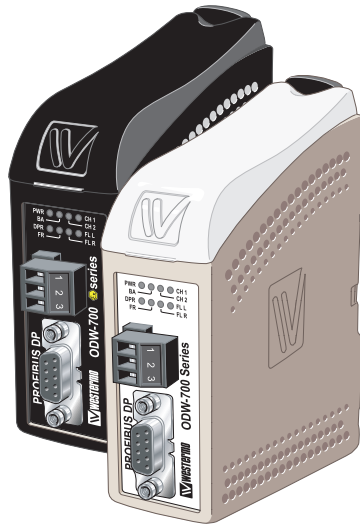

ODW-710-F2

Fibre Optic Modem



Industrial Converter
PROFIBUS DP to
Fibre Optic Link.
Point to Point applications

www.westermo.com

Legal information

The contents of this document are provided "as is". Except as required by applicable law, no warranties of any kind, either express or implied, including, but not limited to, the implied warranties of merchantability and fitness for a particular purpose, are made in relation to the accuracy and reliability or contents of this document. Westermo reserves the right to revise this document or withdraw it at any time without prior notice.

Under no circumstances shall Westermo be responsible for any loss of data or income or any special, incidental, and consequential or indirect damages howsoever caused.

More information about Westermo can be found at the following Internet address:
<http://www.westermo.com>

Safety



Before installation:

Read this manual completely and gather all information on the unit. Make sure that you understand it fully. Check that your application does not exceed the safe operating specifications for this unit.

This unit should only be installed by qualified personnel.

This unit should be built-in to an apparatus cabinet, or similar, where access is restricted to service personnel only.

The power supply wiring must be sufficiently fused, and if necessary it must be possible to disconnect manually from the power supply. Ensure compliance to national installation regulations.

Branch circuit protection (fuse) is required for this unit with rating not exceeding 20 A.

Product should be connected to UL Listed power supplies rated 12 – 48VDC, min 500 mA or 24 VAC, min 500 mA or reliably grounded DC SELV source*.



This unit uses convection cooling. To avoid obstructing the airflow around the unit, follow the spacing recommendations (see Cooling section).

Before mounting, using or removing this unit:

Prevent access to hazardous voltages by disconnecting the unit from the power supply.



Warning! Do not open a connected unit. Hazardous voltages may occur within this unit when connected to a power supply.

Class 1 Laser Product

This unit is designed to meet the Class 1 Laser regulations. However, the user is warned not to look directly into fibre optical fibre port or any connected fibre.

Care recommendations

Follow the care recommendations below to maintain full operation of the unit and to fulfil the warranty obligations.

This unit must not be operated with covers or lids removed.

Do not attempt to disassemble the unit. There are no user serviceable parts inside.

Do not drop, knock or shake the unit. Rough handling beyond the specification may cause damage to internal circuit boards.

Do not use harsh chemicals, cleaning solvents or strong detergents to clean the unit.

Do not paint the unit. Paint can clog the unit and prevent proper operation.

Do not expose the unit to any kind of liquids (rain, beverages, etc).

The unit is not waterproof. Keep the unit within the specified humidity levels.

Do not use or store the unit in dusty, dirty areas. Connectors as well as other mechanical parts may be damaged.

If the unit is not working properly, contact the place of purchase, nearest Westermo distributor office, or Westermo Tech support.

Fibre connectors are supplied with plugs to avoid contamination inside the optical port.

The plug should be fitted when no optical fibre is inserted in the connector, e.g. during storage, service or transportation.

* Applicable for ODW-710-F2 only

Note. Fibre Optic Handling

Fibre optic equipment requires careful handling as the fibre components are very sensitive to dust and dirt. If the fibre is disconnected from the modem, the protective plug on the transmitter/receiver must be replaced. The protective plug must be kept on during transportation. The fibre optic cable must also be protected in the same way.

If this recommendation is not followed, it can jeopardise the warranty.

Cleaning of the optical connectors

In the event of contamination, the optical connectors should be cleaned by using forced nitrogen and some kind of cleaning stick.

Recommended cleaning fluids:

- Methyl-, ethyl-, isopropyl- or isobutyl-alcohol
- Hexane
- Naphtha

Maintenance

No maintenance is required, as long as the unit is used as intended within the specified conditions.

Type	Approval / Compliance
EMC	EN 61000-6-1, Immunity residential environments
	EN 61000-6-2, Immunity industrial environments
	EN 61000-6-3, Emission residential environments
	EN 61000-6-4, Emission industrial environments
	EN 55022, Emission IT equipment, class A
	EN 55024, Immunity IT equipment
	FCC part 15 Class A
	EN 50121-4, Railway signalling and telecommunications apparatus
	IEC 62236-4, Railway signalling and telecommunications apparatus
	DNV Standard for Certification no. 2.4***
Safety	UL/CSA/IEC/EN 60950-1, IT equipment*
	EN 60950-1, IT equipment**
Type	Approval / Compliance
ATEX**	EN 60079-0 and EN 60079-15

* Applicable for ODW-710-F2 only

** Applicable for ODW-710-F2 Ex only

*** Applicable only for article number 3651-0712

FCC Part 15.105

Notice:

This equipment has been tested and found to comply with the limits for a Class A digital device, pursuant to Part 15 of the FCC Rules. These limits are designed to provide reasonable protection against harmful interference when the equipment is operated in a commercial environment.

This equipment generates, uses, and can radiate radio frequency energy and, if not installed and used in accordance with the instruction manual, may cause harmful interference to radio communications. Operation of this equipment in a residential area is likely to cause harmful interference in which case the user will be required to correct the interference at his own expense.

EN 55022 Notice:

This is a class A product. In a domestic environment this product may cause radio interference in which case the user may be required to take adequate measures.



ATEX Information (Applicable for ODW-710-F2 EX only)

General

This unit is intended for use in Zone 2 hazardous location only.

Marking

 II 3 G

Ex nA IIC T4 Gc

SPECIAL CONDITION

WARNING – DO NOT SEPARATE WHEN ENERGIZED

	Indicate that this unit complies with relevant European standards that are harmonised with the 94/9/EC Directive (ATEX).
II	Equipment group II. This unit can be installed in all places with an explosive gas atmosphere other than mines susceptible to firedamp
3	Equipment category 3. A category is the classification according to the required level of protection. This unit ensures the requisite level of protection during normal operation and is intended for use in areas in which explosive atmosphere caused by gases, vapours, mists, or dust mixtures are unlikely to occur or, if they do occur, are likely to do so only infrequently and for a short period only.
G	Indicates protection concerning explosive atmospheres caused by gases, vapours or mists (G).
Ex	Indicates that this unit is in conformity with relevant European Ex standard(s).
nA	Type of protection used. This unit is a non-sparking device "nA" which is constructed to minimize the risk of occurrence of arcs or sparks capable of creating an ignition hazard during conditions of normal operation.
IIC	Gas group, a typical gas i hydrogen.
T4	Temperature class T4 (T4 = 135°C). This unit is classified in accordance with its maximum surface temperature (external and internal).
Gc	Equipment protection level Gc (EPL Gc). Equipment for explosive gas atmospheres, having a "enhanced" level of protection, which is not a source of ignition in normal operation and which may have some additional protection to ensure that it remains inactive as an ignition source in the case of regular expected occurrences. EPL Gc are analogous to the ATEX Categories (Category 3 G = EPL Gc).
SPECIAL CONDITION	This unit has a special condition of use. The special condition for safe use contains safety related information that is necessary for the correct installation and safe use.

Ratings

Power	(12 – 48) VDC; 400 mA
Ambient temperature	$-40^{\circ}\text{C} \leq T_a \leq +60^{\circ}\text{C}$
Ingress protection (IP)	IP21
Maximum surface temperature	135°C (temperature class T4)

Safety Control Drawing

Degree of protection	IP 21
Ambient temperature	-40°C to $+60^{\circ}\text{C}$
Installation spacing	Minimum 25 mm above / below Minimum 10 mm left / right

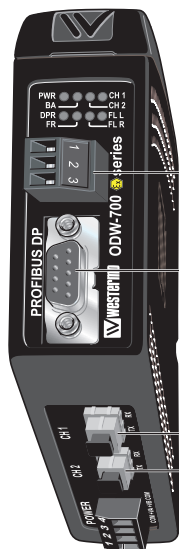

Position	Description	Input / Output values
1	In & out / Relay contact (NO)	$U_{in} = 60 \text{ VDC max}$ $I_{in} = 500 \text{ mA max}$
2	In & out / Relay contact (C)	
3	In & out / Relay contact (NC)	

Galvanically isolated via mechanical relay.
See user manual for proven transient protection.

Position	Description	Input / Output values
1	- / -	$U_{max} = \pm 5 \text{ Vpk}$ $I_{max} = \pm 400 \text{ mA}$ Data rate: 9600 bit/s to 12 Mbit/s
2	- / -	
3	In/out / RxD/TxD-P	
4	Out / CNTR-P	
5	- / DGND	
6	Out / VP	
7	- / -	
8	In/Out / RxD/TxD-N	
9	Not connected	

Position	Description	Output values
Rx	In / Receive port	Max 0 dBm
Tx	Out / Transmit port	

Position	Description	Input values	
1	In / Common	$U_{in} = (10 - 60) \text{ VDC}$ $I_{in} = 550 \text{ mA max}$ $P_{In} = \text{Max } 5.5 \text{ W}$	
2	In / +Voltage A		
3	In / +Voltage B		
4	In / Common		

See section *Type tests and environmental conditions* in this user manual for proven transient protection.

SPECIAL CONDITION FOR SAFE USE

Ambient temperature:

This unit is designed for use in extreme ambient temperature conditions as follows:
 $-40\text{ }^{\circ}\text{C} \leq T_a \leq +60\text{ }^{\circ}\text{C}$

Installation in an apparatus cabinet:

This unit requires installation in an Ex certified apparatus cabinet suitable for the area of use and providing a degree of protection of at least IP54.

Resistance to impact:

This unit requires installation in an apparatus cabinet where adequate resistance to impact is provided by the apparatus cabinet. See "Installation in an apparatus cabinet" above for requirements on the external apparatus cabinet.

Resistance to light:

This unit requires installation in an apparatus cabinet where it is protected from light (for example daylight or light from luminaires).

See "Installation in an apparatus cabinet" above for requirements on the external apparatus cabinet.

Secureness of plugs:

When this unit is installed in an explosive atmospheres, all connectors must be mechanically secured to prevent loosening.

Conductor temperature:

When this unit is installed in locations with high ambient temperature, special precautions shall be taken upon the choice of external conductors and the temperature rating of the conductor(s).

Directive 94/9/EC alongside with other directives:

Directive 2004/108/EC (EMC) applies and to assure a safe performance of this unit under the scope of Directive 94/9/EC, refer to the electromagnetic immunity level specified under "Type tests and environmental conditions" in this manual.

Standards and date of compliance

EN 60079-0 and EN 60079-15
2010-12-17

Declaration of Conformity



Westermo Teleindustri AB

Declaration of conformity

The manufacturer Westermo Teleindustri AB
SE-640 40 Stora Sundby, Sweden

Herewith declares that the product(s)

Type of product	Model	Art no
Industrial fiberoptic repeaters/media converters	ODW-700 series	3651-07xx
	ODW-700EX series	3651-37xx

is in conformity with the following EC directive(s).

No	Short name
2004/108/EC	Electromagnetic Compatibility (EMC)
94/9/EC ¹	Equipment Explosive Atmospheres (ATEX)

References of standards applied for this EC declaration of conformity.

No	Title	Issue
EN 61000-6-1	Electromagnetic compatibility – Immunity residential environments	2007
EN 61000-6-2	Electromagnetic compatibility – Immunity industrial environments	2005
EN 61000-6-3	Electromagnetic compatibility – Emission residential environments	2007
EN 61000-6-4	Electromagnetic compatibility – Emission for industrial environments	2007
EN 55022	Information technology equipment - Emission	2006 + A1:2007
EN 55024	Information technology equipment - Immunity	1998 + A1:2001 + A2:2003
EN 50121-4	Railway applications – Electromagnetic compatibility – Emission and immunity of the signalling and telecommunications apparatus	2006
EN 60079-0	Explosive atmospheres – Equipment – General requirements	2009
EN 60079-15	Electrical apparatus for explosive gas atmospheres – Construction, test and marking of type of protection “n” electrical apparatus	2005

The last two digits of the year in which the CE marking was affixed: 11

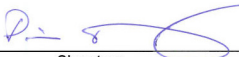

Signature

Pierre Öberg
Technical Manager
15th June 2011

¹ Applicable for ODW-700EX series only.

Postadress/Postal address	Tel.	Telefax	Postgiro	Bankgiro	Org.nr/ Corp. identity number	Registered office
S-640 40 Stora Sundby Sweden	016-428000 Int+46 16428000	016-428001 Int+46 16428001	52 72 79-4	5671-5550	556361-2604	Eskestuna

Type tests and environmental conditions

Electromagnetic Compatibility			
Phenomena	Test	Description	Level
ESD	EN 61000-4-2	Enclosure contact	± 6 kV
		Enclosure air	± 8 kV
RF field AM modulated	IEC 61000-4-3	Enclosure	10 V/m 80% AM (1 kHz), 80 – 800 MHz 20 V/m 80% AM (1 kHz), 800 – 1000 MHz 20 V/m 80% AM (1 kHz), 1400 – 2700 MHz
RF field 900 MHz	ENV 50204	Enclosure	20 V/m pulse modulated 200 Hz, 900 ± 5 MHz
Fast transient	EN 61000-4-4	Signal ports	± 2 kV
		Power ports	± 2 kV
Surge	EN 61000-4-5	Signal ports unbalanced	± 2 kV line to earth, ± 2 kV line to line
		Signal ports balanced	± 2 kV line to earth, ± 1 kV line to line
		Power ports	± 2 kV line to earth, ± 2 kV line to line
RF conducted	EN 61000-4-6	Signal ports	10 V 80% AM (1 kHz), 0.15 – 80 MHz
		Power ports	10 V 80% AM (1 kHz), 0.15 – 80 MHz
Pulse Magnetic field	EN 61000-4-9	Enclosure	300 A/m, 6.4 / 16 µs pulse
Voltage dips and interruption	EN 61000-4-11	AC power ports	10 & 5 000 ms, interruption 200 ms, 40% residual voltage 500 ms, 70% residual voltage
Mains freq. 50 Hz	EN 61000-4-16	Signal ports	100 V 50 Hz line to earth
Mains freq. 50 Hz	SS 436 15 03	Signal ports	250 V 50 Hz line to line
Radiated emission	EN 55022	Enclosure	Class B
	FCC part 15		Class A
Conducted emission	EN 55022	AC power ports	Class B
	FCC part 15	AC power ports	Class B
	EN 55022	DC power ports	Class A
Dielectric strength	EN 60950	Signal port to all other isolated ports	2 kVrms 50 Hz 1min
		Power port to other isolated ports	3 kVrms 50 Hz 1min 2 kVrms 50 Hz 1min (@ rated power < 60W)
Environmental			
Temperature		Operating	–40 to +60°C
		Storage & Transport	–40 to +70°C
		Maximum surface temperature	135°C (temperature class T4)
Humidity		Operating	5 to 95% relative humidity
		Storage & Transport	5 to 95% relative humidity
Altitude		Operating	2 000 m / 70 kPa
Service life		Operating	10 year
Vibration	IEC 60068-2-6	Operating	7.5 mm, 5 – 8 Hz 2 g, 8 – 500 Hz
Shock	IEC 60068-2-27	Operating	15 g, 11 ms
Packaging			
Enclosure, ODW-710-F2	UL 94	PC / ABS	Flammability class V-1
Enclosure, ODW-710-F2 EX		Cabelec 6141	
Dimension W x H x D			35 x 121 x 119 mm
Weight			0.26 kg
Degree of protection			IP 21
Cooling	IEC 529	Enclosure	Convection
Mounting			Horizontal on 35 mm DIN-rail

Functional description

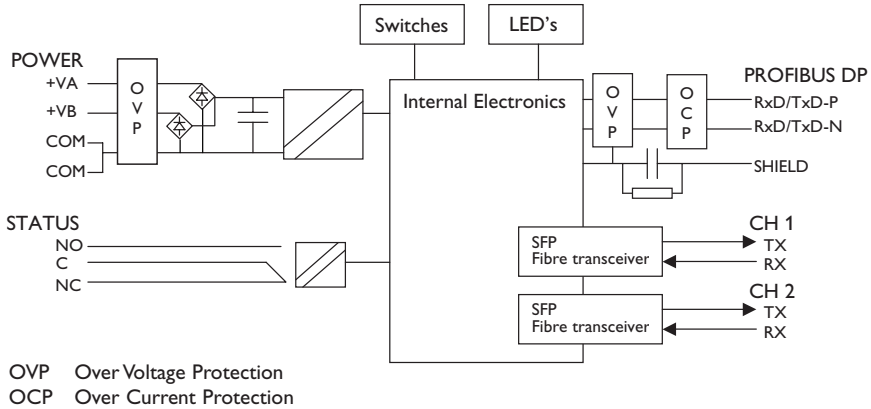

Converter PROFIBUS DP – optical fibre

ODW-710-F2 is a fibre optic modem that converts between electrical PROFIBUS DP and a fibre optical link.

Repeater – optical fibre links

ODW-710-F2 is a fibre optic repeater that repeats received data from one fibre link out to the other link. This is useful e.g. for long distance communication, where electromagnetic interference may occur or when isolation of the electrical network is needed. The maximum optical fibre distance depends on selected fibre transceiver and fibre type. Distances up to 80 km (50 miles) are available.

Data rate up to 12 Mbit/s

ODW-710-F2 converts PROFIBUS DP data using data rates from 9 600 bit/s up to 12 Mbit/s. Retiming of the PROFIBUS DP data ensures that the correct signal form is transmitted from the ODW-710-F2 converter.

Automatic data rate detection

The PROFIBUS data rate is set automatically as soon as the ODW-710-F2 receives a correct data frame, whether data is received from PROFIBUS DP or the fibre optical link. The detected data rate remains until a number of consecutive faulty received frames have been detected or no further frames are detected within the timeout period. The timeout period is set by switches, with the default setting of 31 faulty frames or 5 seconds without any received frames.

Interface specifications

Power	
Rated voltage	ODW-710-F2: 12 to 48 VDC and 24 VAC ODW-710-F2 Ex: 12 to 48 VDC
Operating voltage	ODW-710-F2: 10 to 60 VDC and 20 to 30 VAC ODW-710-F2 Ex: 10 to 60 VDC
Rated current	400 mA @ 12 VDC 200 mA @ 24 VDC 100 mA @ 48 VDC
Rated frequency	ODW-710-F2: DC and 48 to 62 Hz ODW-710-F2 Ex: DC
Inrush current I _{2t}	0.2 A ² s
Startup current*	1.0 A _{peak}
Polarity	Reverse polarity protected
Redundant power input	Yes
Isolation to	PROFIBUS DP and Status port
Connection	Detachable screw terminal
Connector size	0.75 – 2.5 mm ² (AWG 18 – 13) Connect the unit using at least 18 AWG (0.75 mm ²) wiring
Shielded cable	Not required

* External supply current capability for proper startup

Status	
Port type	Signal relay, changeover contacts
Rated voltage	U _p to 48 VDC
Operating voltage	U _p to 60 VDC
Contact rating	500 mA @ 48 VDC
Contact resistance	< 50 mΩ
Isolation to	PROFIBUS DP and Power port
Connection	Detachable screw terminal
Connector size	0.2 – 2.5 mm ² (AWG 24 – 13)
Shielded cable	Not required

PROFIBUS DP (RS-485)	
Electrical specification	EIA RS-485 / EN 50 170
Data rate	9 600 bit/s, 19.2, 93.75, 187.5, 500 kbit/s, 1.5, 3, 6 and 12 Mbit/s
Data format	8 data bits, even parity, 1 stop bit, 11 bits total
Protocol	PROFIBUS DP / EN 50170
Data Rate detection	Yes, compliant with EN 50 170
Retiming	Yes
Turn around time	In accordance with EN 50 170
Transmission range	≤ 1200 m, depending on data rate and cable type (EIA RS-485)
Settings	None, external termination and failsafe biasing
Protection	Installation Fault Tolerant (up to ±60 V)
Isolation to	Power and Status port
Connection	9-pin D-sub female
Shielded cable	Not required
Conductive housing	Isolated to all other circuits and housings

Optical Power Budget

The allowed link length is calculated from the optical power budget (OPB), the available optical power for a fibre-optic link, and the attenuation of the fibre, comprising losses due to in-line connectors, splices, optical switches and a margin for link ageing (typical 1.5 dB for 1300 nm).

The worst-case optical power budget (OPB) in dB for a fibre-optic link is determined by the difference between the transmitter's output optical power (min) and the receiver input sensitivity (max).

FX (Fibre)	SM-LC80	SM-LC40	SM-LC20	MM-LC2
Fibre connector	LC duplex	LC duplex	LC duplex	LC duplex
Fibre type	Singlemode 9/125 µm	Singlemode 9/125 µm	Singlemode 9/125 µm	Multimode, 62.5/125 µm
Wavelength	1550 nm	1310 nm	1310 nm	1310 nm
Transmitter Output optical power min/max	-5/0 dBm	-5/0 dBm	-15/-8 dBm	-20/-14 dBm
Receiver Input sensitivity, max	-35 dBm	-35 dBm	-34 dBm	-31 dBm
Receiver Input optical power, max	0 dBm	0 dBm	0 dBm	-8 dBm
Optical power budget, worst-case	30 dB	30 dB	19 dB	11 dB
Transceiver type	Small Form Factor Pluggable (SFP) Multi-Sourcing Agreement (MSA) compliant			
Laser class	Class 1, IEC 825-1 Accessible Emission Limit (AEL)			

FX (Fibre)	Bi-Di LC-40	Bi-Di LC-20
Fibre connector	LC Simplex	LC Simplex
Fibre type	Singlemode 9/125 µm	Singlemode 9/125 µm
Wavelength nm, connector 1 Wavelength nm, connector 2	Tx 1310, Rx 1550 Tx 1550, Rx 1310	Tx1310, Rx 1550 Tx 1550, Rx 1310
Transmitter Output optical power min/max	-8/0 dBm	-14/8 dBm
Receiver Input sensitivity, max	-34 dBm	-32 dBm
Receiver Input optical power, max	-3 dBm	0 dBm
Optical power budget, worst-case	26 dB	18 dB
Bit error rate (BER)	$< 1 \times 10^{-10}$	$< 1 \times 10^{-10}$
Transceiver type	Small Form Factor Pluggable (SFP) Multi-Sourcing Agreement (MSA) compliant	
Laser class	Class 1, IEC 825-1 Accessible Emission Limit (AEL)	

Location of Interface ports, LED's and DIP-switches

ODW-710-F2

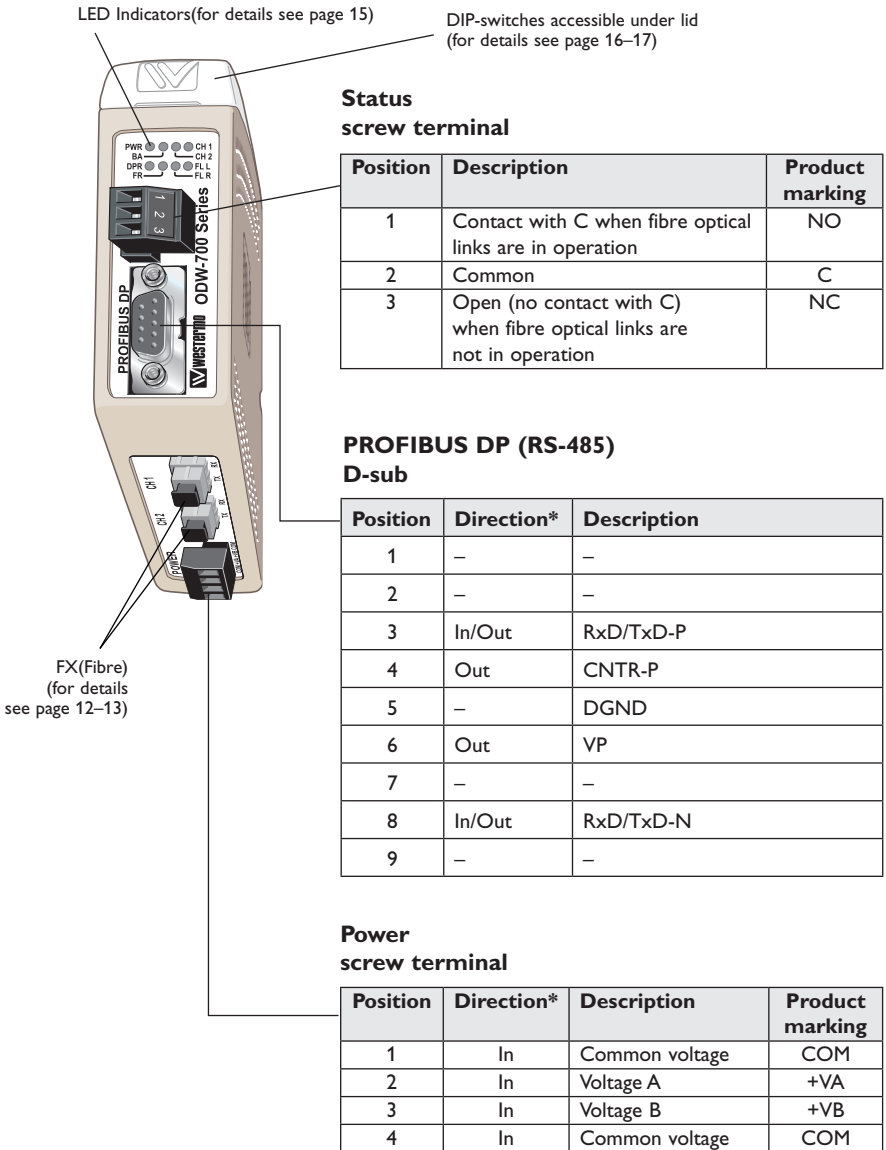

* Direction relative this unit

LED Indicators

LED	Status	Description
PWR Power	ON	Power is on.
	Flashing	Unit configured as focal point (DIP-switch S2:3 is ON).
	OFF	Power is off.
BA Bus active	ON	Data rate has been identified and data frames are being received on the electrical or optical interface.
	OFF	Data rate has not been identified.
CH 2 Channel 2 link status	ON	Fibre link to other unit has been established at CH 2.
	Flashing	Optical power detected but link to other unit has not been established at CH 2.
	OFF	No optical power detected and no link to other unit has been established at CH 2.
CH 1 Channel 1 link status	ON	Fibre link to other unit has been established at CH 1.
	Flashing	Optical power detected but link to other unit has not been established at CH 1.
	OFF	No optical power detected and no link to other unit has been established at CH 1.
DPR Receive PROFIBUS DP	Flash	Data received on the electrical interface and transmitted out on the optical interface.
	OFF	No data received on the electrical interface.
FR Receive fibre link	Flash	Data received on the optical interface and transmitted out on the electrical interface.
	OFF	No data received on the optical interface.
FL R Failure link remote	ON	Remote fibre link failure. A fibre link is out of operation at any other unit than this one.
	Flashing	Hardware error or invalid configuration.
FL L Failure link local	ON	Local fibre link failure. A fibre link is out of operation at this unit.
	Flashing	Hardware error or invalid configuration.

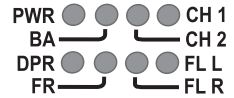

DIP-switch settings



Before setting DIP-switches:

Prevent damage to internal electronics from electrostatic discharges (ESD) by discharging your body to a grounding point (e.g. use of wrist strap).

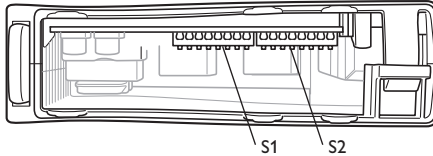

S2 DIP-switch



Multidrop mid unit or redundant ring member.



5 seconds interruption in receiving frames, until inactive BA*.



Multidrop end unit.
E.g. the first or last unit in a multidrop network.

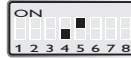

10 seconds interruption in receiving frames, until inactive BA*.



Redundant ring master unit.
Only one master unit allowed in a ring.

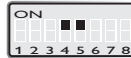



















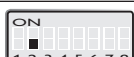







20 seconds interruption in receiving frames, until inactive BA*.

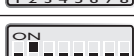

65535 t_{bit} interruption in receiving frames, until inactive BA.

* See section "About the automatic data rate detection" on page 25 for a more detailed description.

S1 DIP-switch	S2 DIP-switch	Description
		1 faulty frame before data rate seen as unidentified*. S1: No extended retry limit.
		2 faulty frames before data rate seen as unidentified*. S1: No extended retry limit.
		3 faulty frames before data rate seen as unidentified*. S1: No extended retry limit.
		4 faulty frames before data rate seen as unidentified*. S1: No extended retry limit.
		5 faulty frames before data rate seen as unidentified*. S1: No extended retry limit.
		6 faulty frames before data rate seen as unidentified*. S1: No extended retry limit.
		7 faulty frames before data rate seen as unidentified*. S1: No extended retry limit.
		8 faulty frames before data rate seen as unidentified*. S1: No extended retry limit.
		31 faulty frames before data rate seen as unidentified*. S1: Extended retry limit.
		63 faulty frames before data rate seen as unidentified*. S1: Extended retry limit.
		127 faulty frames before data rate seen as unidentified*. S1: Extended retry limit.
		255 faulty frames before data rate seen as unidentified*. S1: Extended retry limit.
		Set status port at local fibre link (FL L) error only.
		Factory default

* See section “About the automatic data rate detection” on page 25 for a more detailed description.

Multidrop configuration

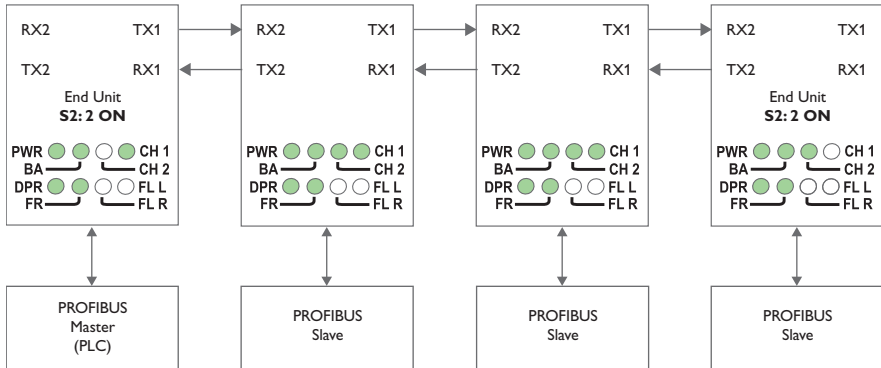

Prepare the PROFIBUS units

⚙️ Configure PROFIBUS network, with master and slaves. Check that the application is running correctly with the electrical PROFIBUS network.

Note: In an ODW-710-F2 fibre optic network there will be some additional processing delays that do not exist in an electrical bus. It is possible that the PROFIBUS application must be adjusted to accommodate these delays if using many ODW-710-F2 units in a large network.

See page 22 “Calculating system processing delay” for more information on how to determine the overall system delay time.

Prepare the fibre optical network

- ⚙️ The first and last ODW-710-F2 units must be configured as Multidrop end units by setting DIP-switch S2:2 to the ON position. (End units only have one fibre pair each and must know that this is a fact)
- ⚙️ Connect the fibre pairs between the units. Always connect CH 1 from one unit to CH 2 on the next unit as shown in the picture above.
- ⚙️ Connect the power supply to all units and verify that all fibre links become active. (CH 1 and CH 2 LED's are on, FL L and FL R LED's are off).
- ⚙️ Connect the PROFIBUS master and slaves to the corresponding ODW-710-F2 unit.
- ⚙️ The network is now up and running.

Data from the PROFIBUS master is received at the ODW-710-F2 electrical port (as indicated by the DPR LED). The data rate is automatically detected (as indicated by the BA LED) and data bits are retimed according to the determined rate and sent out on the optical fibre at CH 1.

The first ODW-710-F2 slave unit receives data at optical fibre CH 2 (as indicated by the FR LED). The data rate is automatically detected (as indicated by the BA LED) and data is sent out on the electrical port. The slave unit also repeats incoming data on CH 2 to the next slave unit.

Responses from the PROFIBUS slaves are processed in the same fashion and sent back to the PROFIBUS master in the opposite direction.

Behavior during optical link failure

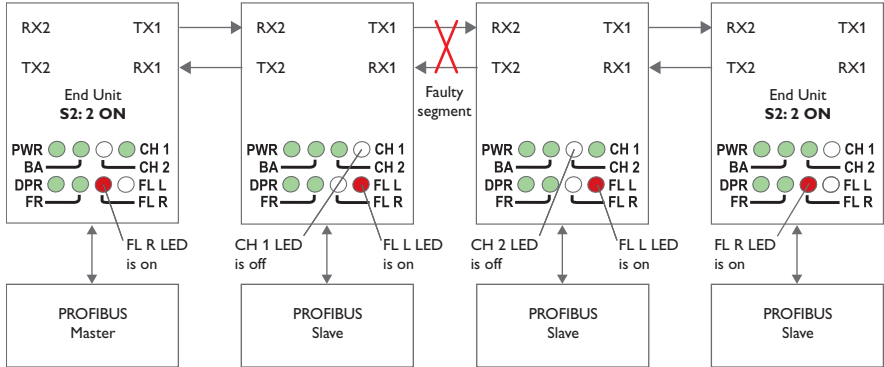

If an optical fibre segment fails, all communication with units beyond the faulty fibre segment will be lost. To determine which fibre segment has failed, look at the FL L, CH 1 and CH 2 LED's as show in the picture above.

Redundant ring configuration

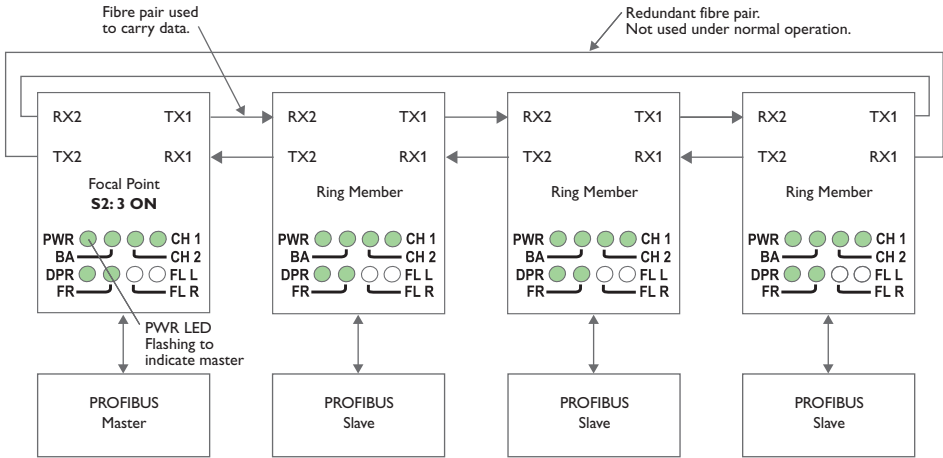

Prepare the PROFIBUS units

- Configure PROFIBUS network, with master and slaves. Check that the application is running correctly with the electrical PROFIBUS network.

Note: In an ODW-710-F2 fibre optic network there will be some additional processing delays that do not exist in an electrical bus. It is possible that the PROFIBUS application must be adjusted to accommodate these delays if using many ODW-710-F2 units in a large network.

See page 22 “Calculating system processing delay” for more information on how to determine the overall system delay time.

Prepare the fibre optical network

- One, and only one, of the ODW-710-F2 units must be configured as a ring focal point by setting DIP-switch S2:3 to the ON position. (The ring focal point acts as a logical end point in the optical fibre ring, thus forming a bus type of structure)
- Connect the fibre pairs between the units. Always connect CH 1 from one unit to CH 2 on the next unit as shown in the picture above.
- Connect the power supply to all units and verify that all fibre links become active. (CH 1 and CH 2 LED's are on, FL L and FL R LED's are off).
- Connect the PROFIBUS master and slaves to the corresponding ODW-710-F2 unit.

Note: It is not required that the PROFIBUS master is connected to the ODW-710-F2 ring focal point, but it makes sense if one wishes to keep the installation “tidy” and easy to maintain.

- The network is now up and running.

Data from the PROFIBUS master is received at the ODW-710-F2 electrical port (as indicated by the DPR LED). The data rate is automatically detected (as indicated by the BA LED) and data bits are retimed according to the determined rate and sent out on the optical fibre at CH 1.

The first ODW-710-F2 ring member receives data at optical fibre CH 2 (as indicated by the FR LED). The data rate is automatically detected (as indicated by the BA LED) and data is sent out on the electrical port. The ring member also repeats incoming data on CH 2 out on CH 1 on to the next ring member.

Responses from the PROFIBUS slaves are processed in the same fashion and sent back to the PROFIBUS master in the opposite direction.

Behavior during optical link failure

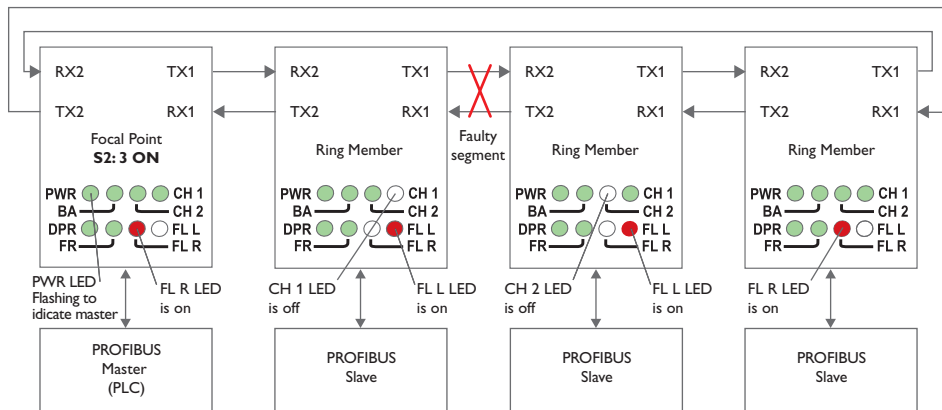

If an optical fibre segment fails, the ODW-710-F2 focal point will switch mode and start sending out data on both optical fibre ports, CH 1 and CH 2, simultaneously.

Responses from the PROFIBUS slaves are sent back to the PROFIBUS master in the opposite direction, as normal.

To determine which fibre segment has failed, look at the FL L, CH 1 and CH 2 LED's as show in the picture above.

Note: If a fibre link fails there will be some time before the system reconfigures itself during witch data may be corrupted or lost. See page 23 "Reconfiguration time under faulty condition" for more information on how to determine the system reconfiguration time.

Calculating system processing delay

Data exchange between a PROFIBUS DP master and slave via ODW-710-F2 fibre optic link will be delayed due to the length of the optical fibre and the signal processing within the ODW-710-F2. The signal processing delay is dependent on the data rate, and the fibre delay is dependent on the total length of the optical fibre. The additional time resulting from the optical fibre and ODW-710-F2 is the Overall system delay.

	Delay @ < 1.5 Mbit/s	Delay @ 3 to 12 Mbit/s
Optical fibre length delay (typical)	5 μ s/km	5 μ s/km
Signal processing, electrical to fibre (max)	1 t_{bit} + 1 μ s	9 t_{bit} + 1 μ s
Signal processing, fibre to electrical (max)	0.3 μ s	0.3 μ s
Signal processing, fibre to fibre (max)	1.3 μ s	1.3 μ s

Note $t_{bit} = 1 / \text{Baud rate}$ (Baud rate in bit/s)

Example

One PROFIBUS DP master and 11 slaves with data rate 12 Mbit/s. 12 ODW-710-F2 units with a total fibre length of 40 km. A data frame sent from the master to a slave at the farthest end of the optical network.

1. Optical fibre length delay: The total optical fibre length delay.

$$40 \times 5 \mu\text{s} = 200 \mu\text{s}$$

2. Signal processing electrical to fibre: Signal processing delay (ODW-710-F2 units connected to PROFIBUS DP master).

$$9 t_{bit} + 1 \mu\text{s} = 9 \times 0.083 \mu\text{s} + 1 \mu\text{s} \times 2 = 1.1 \mu\text{s}$$

3. Signal processing fibre to electrical: Signal processing delay (ODW-710-F2 units connected to PROFIBUS DP slave).

$$0.3 \mu\text{s}$$

4. Signal processing fibre to fibre: The optical repeater delay x Number of optical repeaters (excluding the ODW-710-F2 units connected to PROFIBUS DP master and addressed slave).

$$(12 - 2) \times 1.3 \mu\text{s} = 13 \mu\text{s}.$$

5. The system delay is calculated by summing the delays in item 1 to 4 above:

$$200 \mu\text{s} + 1.1 \mu\text{s} + 0.3 \mu\text{s} + 13 \mu\text{s} = 214 \mu\text{s}$$

Reconfiguration time under faulty condition

The reconfiguration time is determined by the time it takes to detect a faulty fibre segment plus the time it takes to transport an error status message through to the ODW-710-F2 focal point unit. The time to transport an error status message to the focal point unit is dependent on how many units the error status message has to be repeated through and the total fibre length delay.

	Delay
Optical fibre length delay (typical)	5 μ s/km
Error detection	3 μ s
Error repeater delay	0.8 μ s

During reconfiguration data may be corrupted or lost.

Example

A system with one PROFIBUS DP master, 11slaves, 12 ODW-710-F2 units and a total fibre length of 2 km. The worst-case reconfiguration time would be:

1. Optical fibre length delay: The total optical fibre length delay.

$$2 \times 5 \mu\text{s} = 10 \mu\text{s}$$

2. Error detection: The time it takes to detect a faulty fibre segment.

Always 3 μ s.

3. Optical repeaters: The optical repeater delay x Number of optical repeaters (excluding the ODW-710-F2 units connected to PROFIBUS DP master and addressed slave).

$$(12 - 2) \times 0.8 \mu\text{s} = 8 \mu\text{s}.$$

4. The reconfiguration time is calculated by summing the delays in item 1 to 3 above:

$$10 \mu\text{s} + 3 \mu\text{s} + 8 \mu\text{s} = 21 \mu\text{s}$$

About the interfaces

Power

The power terminal has two independent inputs, +VA and +VB, allowing redundant power input.

The ODW-710-F2 power supply is galvanically isolated from all other interfaces.

Optical fibre interfaces

ODW-710-F2 uses Small Form Factor Pluggable (SFP) transceivers. This means that a wide range of different fibre transceivers and connectors can be used (see page 12–13).

PROFIBUS DP interface

The PROFIBUS DP interface is a female 9-position D-sub. Pin assignments are compliance with the PROFIBUS standard EN 50 170.

Status port

The status port connects to an internal relay which may be used to trigger an external alarm if a fault condition occurs. During normal operation pins 1 and 2 are in contact with each other, and pins 2 and 3 are isolated. During an optical link failure, or power failure, pins 1 and 2 are isolated, and pins 2 and 3 are in contact with each other.

Optical link failures can be classified in to two categories, local or remote, as indicated by the FL L and FL R LED's. A local link failure is when an optical link is down at this particular unit. A remote link failure is when an optical link is down at some other unit.

From the factory, the status port is set to trigger on both types of link failures. However, by setting DIP-switch S1:1 to the ON position, the status port will only trigger when a local link failure has occurred.

About the automatic data rate detection

ODW-710-F2 automatically detects the data rate by monitoring incoming PROFIBUS data frames on both the electrical and optical interfaces. When the data rate has been established the BA LED will go active.

If no data frames are transmitted for a period of time the automatic data rate detection will restart and the BA LED will go inactive.

The idle time before the automatic data rate detection restarts is set using DIP-switches S2:4 and S2:5. The factory default setting is 5 seconds.

The automatic data rate detection determines the actual data rate by listening for PROFIBUS Start Delimiters (SD1 – SD4) at the beginning of each data frame. If one or more Start Delimiters are lost the automatic data rate detection will rest start.

The number of lost Start Delimiters before the automatic data rate detection restarts is set using DIP-switches S1:2 and S2:6 – S2: 8. The factory default setting is 31 faulty frames (31 lost Start Delimiters).

Note: Start Delimiters can be lost during an electrical or optical disturbance.

For example a PROFIBUS slave unit is connected/disconnected or an optical fibre is disconnected. It is advisable to start of by using the factory default settings and only manipulate them if a problem exists.

Mounting

This unit should be mounted on 35 mm DIN-rail, which is horizontally mounted inside an apparatus cabinet, or similar. Snap on mounting, see figure.

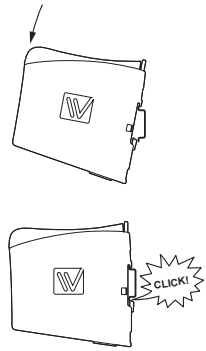

Cooling

This unit uses convection cooling. To avoid obstructing the air-flow around the unit, use the following spacing rules. Minimum spacing 25 mm (1.0 inch) above /below and 10 mm (0.4 inches) left /right the unit. Spacing is recommended for the use of unit in full operating temperature range and service life.

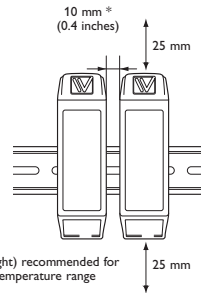

Removal

Press down the black support at the top of the unit. See figure.

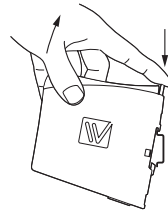



Westermo • SE-640 40 Stora Sundby, Sweden
Tel +46 16 42 80 00 Fax +46 16 42 80 01
E-mail: info@westermo.com
www.westermo.com

Sales Units

Westermo Data Communications

China

sales.cn@westermo.com
www.cn.westermo.com

France

infos@westermo.fr
www.westermo.fr

Germany

info@westermo.de
www.westermo.de

North America

info@westermo.com
www.westermo.com

Singapore

sales@westermo.com.sg
www.westermo.com

Sweden

info.sverige@westermo.se
www.westermo.se

United Kingdom

sales@westermo.co.uk
www.westermo.co.uk

Other Offices



For complete contact information, please visit our website at www.westermo.com/contact or scan the QR code with your mobile phone.