

# NetBlazer Series Multiservice Tester

POWERFUL, COMPREHENSIVE AND FAST MULTISERVICE TESTING



Feature(s) of this product is/are protected by one or more of patent appl. US 2012/0307666 A1 and equivalents in other countries.

Comprehensive, yet simple test suites for field technicians to easily turn up, validate and troubleshoot DSn/PDH, ISDN, SONET/SDH, OTN, Fibre Channel, Ethernet, CPRI/OBSAI and SyncE/1588 PTP services at up to 11.3 Gbit/s.

## KEY FEATURES AND BENEFITS

Comprehensive testing for DSn/PDH, ISDN, SONET/SDH, OTN and Ethernet interfaces up to 10 Gbit/s

Efficiently assess Fibre Channel networks with best-in-class coverage via 1X, 2X, 4X, 8X and 10X interfaces

Packet synchronization turn-up and troubleshooting (SyncE/1588 PTP)

FTTA validation for CPRI from 1.2 Gbit/s to 9.8 Gbit/s via BER testing

Complete ISDN solution for testing and troubleshooting DS1 or E1 primary rate interfaces (PRI)

Simplified BER testing with pass/fail indicators based on user-defined thresholds

OTN testing (as per ITU-T G.709) including forward error correction (FEC)

Faster Ethernet service activation with bidirectional and one-way delay EtherSAM (ITU-T Y.1564) and RFC 2544 test suites, multiservice traffic generation, Through mode and bit-error-rate (BER) testing

True wire-speed, stateful TCP throughput based on RFC 6349 for undisputable SLA enforcement of Ethernet services

Carrier Ethernet OAM testing covering Y.1731, G.8113.1 (MPLS-TP), MEF and 802.1ag standards

Full line-rate packet capture and advanced filtering from 10M to 10G

Layer-2 transparency testing with predefined configurations

Unprecedented configuration simplicity with hybrid touchscreen/keypad navigation and data entry

Increase technician autonomy and productivity with intelligent discovery of remote EXFO Ethernet testers, as well as in-service Ethernet testing via dual-port Through mode

No data interpretation errors with revolutionary new GUI on 7-inch TFT screen, historical event logger, visual gauges and 3D-icon depictions of pass/fail outcomes

Simpler reporting with integrated Wi-Fi and Bluetooth connectivity capabilities

Centralized support for injection/monitoring of errors and alarms, trace messaging, overhead monitoring/manipulation and performance monitoring statistics

Integrated applications to test VoIP services, and additional IP test utilities, including VLAN scan and LAN discovery via EXpert VoIP and EXpert IP test tools

Extended field autonomy with a compact, lightweight platform equipped with a long-duration battery pack

EXFO Connect-compatible: automated asset management; data goes through the cloud and into a dynamic database

Offers EXFO TFv—Test Function Virtualization, including FTB Anywhere floating licenses and FTB OnDemand time-based licenses

## PLATFORM COMPATIBILITY



Platform  
FTB-1

EXFO

## THE ULTRA-PORTABLE CHOICE FOR MULTISERVICE TESTING

The ongoing transition towards a converged network infrastructure for legacy DSn/PDH, ISDN, SONET/SDH, OTN, Fibre Channel and packet-based Ethernet services requires a test tool that can cover a wide range of interfaces and rates, without sacrificing portability, speed or cost. Leveraging the powerful, intelligent FTB-1 handheld platform, the NetBlazer streamlines processes and empowers field technicians to test and validate DSn/PDH, ISDN, SONET/SDH, OTN, Fibre Channel and Ethernet circuits efficiently.

### Powerful and Fast

The NetBlazer is a fully integrated DSn/PDH, ISDN, SONET/SDH, OTN, Fibre Channel and Ethernet handheld tester. It offers a 7-inch touchscreen with unprecedented configuration simplicity via hybrid touchscreen/keypad navigation. Platform connectivity is abundant via Wi-Fi, Bluetooth, Gigabit Ethernet or USB ports, making it accessible in any environment.

#### What you need for any DSn/PDH, ISDN, SONET/SDH, OTN, Fibre Channel or Ethernet application

- › Installation, commissioning and maintenance of access and metro networks
- › Turn-up of DSn/PDH, ISDN or SONET/SDH circuits
- › Performance assessment of Carrier Ethernet services
- › Validation of OTN networks and services
- › Installation, activation and maintenance of metro Ethernet networks
- › Deployment of active Ethernet (point-to-point) access services
- › Installation and activation of Fibre Channel networks
- › Testing and troubleshooting
- › In-service troubleshooting of live traffic
- › Performance monitoring of DSn/PDH, ISDN, SONET/SDH and OTN circuits
- › Round-trip delay assessment of transport circuits
- › BER testing up to 11.3 Gbit/s
- › FTTA validation for CPRI from 1.2 Gbit/s to 9.8 Gbit/s via BER testing

#### DSn/PDH, ISDN, SONET/SDH, OTN, FIBRE CHANNEL AND ETHERNET AT UP TO 10 Gbit/s

If the need is for multiservice testing up to 10 Gbit/s, then the NetBlazer is the perfect solution.

- › RJ-45 port for electrical 10/100/1000M Ethernet
- › SFP+ port for OC-192, STM-64, 10 GigE, Fibre Channel 8X/10X, OTU2, and 9.8 Gbit/s for CPRI
- › BNC port for DS3 or E1/E3/E4 or STS-1e/STS-3e or STM-0e/STM-1e
- › SFP ports for OTU1, OC-1/3/12/48 or STM-0/1/4/16, Fibre Channel 1X/2X/4X or 100/1000M Ethernet, as well as CPRI 1.2G to 6.1G and OBSAI 3.1G
- › Bantam and RJ-48C ports for DS1, E1, ISDN PRI. BNC is also available for E1 including ISDN PRI, as well as E3 and E4 rates.
- › DS1/DS3 and E1/E3/E4 testing
- › SONET/SDH and OTN BER testing with configurable threshold settings
- › Coupled, Decoupled and Through mode testing
- › Error and alarm insertion and monitoring
- › Overhead monitoring and manipulation
- › High-order and low-order mappings
- › Tandem connection monitoring (TCM)
- › Pointer manipulation, including pointer sequence testing as per Telcordia GR-253, ANSI T1.105-03 and ITU G.783
- › Performance monitoring as per G.821, G.826, G.828, G.829, M.2100, M.2101
- › Frequency analysis and offset generation
- › Automatic protection switching
- › Service-disruption time measurements
- › Round-trip delay measurements
- › Dual DS1/DS3 receiver (Rx) support
- › DS1 loop codes and NI/CSU emulation
- › DS1/DS3 autodetection of line code, framing and pattern
- › DS1 automated multipattern BER
- › DS1/DS0 monitoring including ABCD signaling bits
- › DS1 FDL and DS3 FEAC
- › Fractional T1/E1 testing
- › ISDN PRI for DS1 or E1 interfaces
- › External clock sync support
- › 10 Base-T to 10 GigE testing
- › EtherSAM (ITU-T Y.1564) (bidirectional and one-way delay)
- › RFC 2544 (bidirectional and one-way delay)
- › Traffic generation and monitoring
- › Through mode
- › Full line-rate packet capture and advanced filtering from 10M to 10G
- › Carrier Ethernet OAM (MEF, 802.1ag, Y.1731 and G.8813.1 MPLS-TP)
- › Dual-port testing
- › Intelligent autodiscovery
- › IPv6 testing
- › TCP throughput
- › 1588 PTP and SyncE
- › VLAN's including E-VLAN, S-VLAN and C-VLAN
- › MPLS
- › Cable testing
- › Dual Test Set mode
- › Smart loopback
- › Fibre Channel 1X, 2X, 4X, 8X, 10X
- › FTTA BER testing up to 9.8 Gbit/s

## REVAMPED SETUP PROCEDURES

The new Test Configurator not only allows tests to be easily setup, it provides critical test info immediately after the actual setup stage. In the screenshot to the right, the RFC 2544 test was selected with Throughput and Back-To-Back tests enabled (Frame Loss and Latency are disabled). The green arrow pointing up confirms that the link is up. The destination IP address is resolved and the test is ready to be executed. The Test Configurator covers all stages of testing: setup, review and execution.



The control panel has icons to access the most important testing elements, buttons for the Setup, Results and Functions screens, as well as a clear pass/fail indicator. Field techs have the assurance that their testing time is optimized.

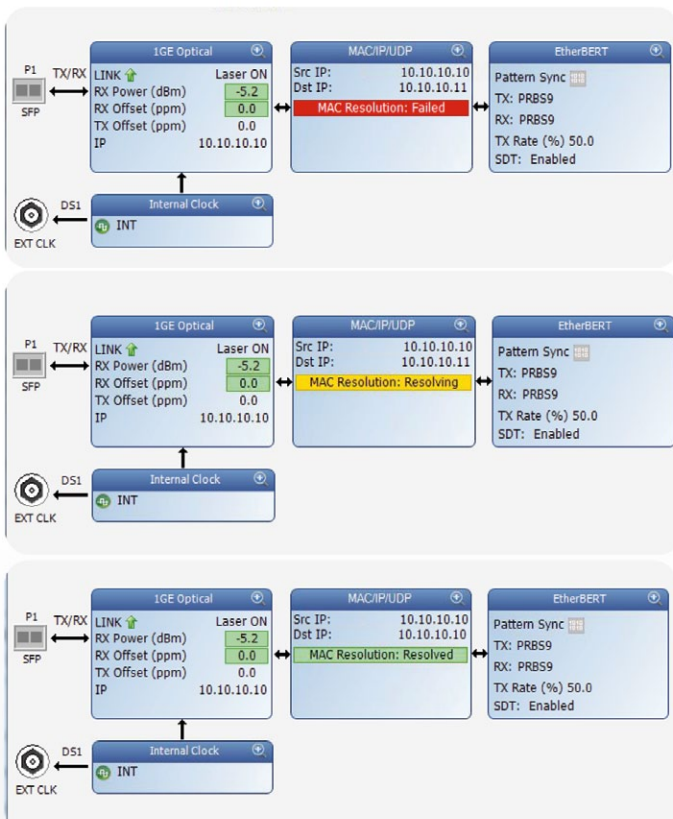

**All OK**

FTB-880 NetBlazer

Pass

No Alarm

0d:00:03:14

**Yellow indicator of previous event**

FTB-880 NetBlazer

Pass

No Alarm

0d:00:01:18

**Exact Alarm description**

FTB-880 NetBlazer

Pass

FCS

0d:00:06:45

**Failed test**

FTB-880 NetBlazer

Fail

Alarms

0d:00:02:49

**FTB-880 NetBlazer**

PASS

No Alarm

0d 00:01:40

Stop TX

Save Load Report Discover Remote

Lpbk Tool Reset

Setup Results Functions

Step-by-step testing status

## Setting a New GUI Standard: Unprecedented Simplicity in Configuration Setup and Navigation

The NetBlazer's intelligent situational configuration setup feature guides technicians through complete, accurate testing processes (suggestion prompts, help guides, etc.). It reduces navigation by combining associated testing functions on a single screen, and offers intelligent autodiscovery that allows a single technician to perform end-to-end testing.

### Dedicated Quick-Action Buttons

- › Remote discovery to find all the other EXFO units
- › Laser on/off
- › Test reset to clear the results and statistics while running a test
- › Report generation
- › Save or load test configurations
- › Quick error injection
- › Enable second Ethernet loopback port

### Assorted Notifications

- › Clear indication of link status for single or dual ports
- › Negotiated speed display for single or dual ports
- › Power status available at all times for single or dual ports
- › Pass/fail indication at all times
- › Pattern and clock synchronization
- › Frequency offset with valid-range color indicator
- › Overhead overwrite indicator
- › Error/alarm injection
- › Alarm hierarchy pinpointing the root-cause (when possible)

### Streamlined Navigation

- › Remote discovery button available at all times; no reason to leave your current location to scan for a remote unit
- › Testing status can be maximized to fill the entire screen by simply clicking on the alarm status button; whether the unit is in your hand or across the room, test results can be easily determined with a simple glance at the display screen
- › RFC 2544 results and graphs are also maximized in a single page; no need to navigate through multiple screens to view individual RFC subtest results
- › Simplified test structure definition using task-based test application selection, signal configuration front end and smart timeslot selection
- › Centralized functions: error/alarm management, performance monitoring and overhead manipulation/monitoring

## Key DSn/PDH and SONET/SDH Features

### Simplified BER Testing

The NetBlazer provides the ability to pre-configure bit-error-rate (BER) thresholds that are user-defined prior to running the test. This allows for a simple pass/fail verdict at the conclusion of the test, leaving no room for misinterpretation of the test results.

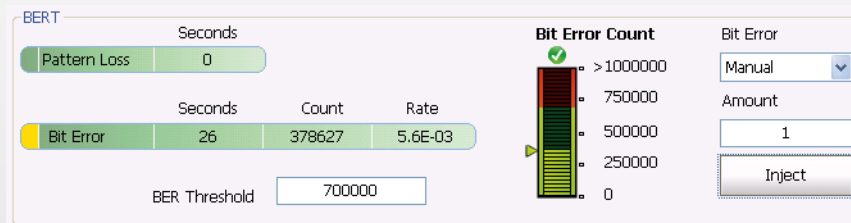
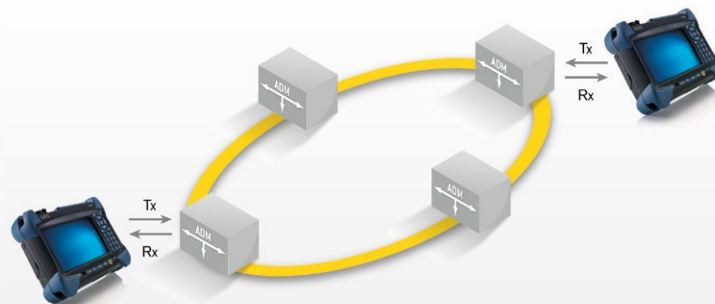



### Decoupled Mode

The Decoupled mode enables the user to independently configure the Tx and Rx ports of the NetBlazer module. This makes it possible to test the mapping and demapping functionality of a network element or at cross-connect points in the network.



### Through Mode

This mode is required for in-service monitoring of the network. The NetBlazer can be inserted in-line on a specific link to monitor and analyze the errors and alarms in a non-intrusive manner.



### Simplified Error Injection

This NetBlazer feature enables the user to inject errors with a single click from any screen, allowing technicians to ensure circuit continuity prior to starting a test. Furthermore, the error injection functionality can be preprogrammed for any given type of error, and not just for bit errors.

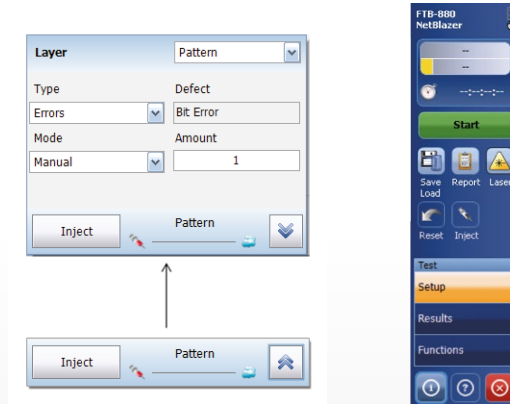

### Complete Overhead Monitoring

The NetBlazer offers access to all SONET/SDH or OTN overhead (OH) bytes. Furthermore, by selecting any given OH byte, the user can retrieve additional detailed information about that byte without having to switch pages.

TX STS-1 Timeslot												RX STS-1 Timeslot											
Transport OH												Transport OH											
SECTION				VT				VT				SECTION				VT							
A1	A1	30	J1	V5								A1	A1	30	J1	V5							
B6	B6	01	00	0C								B6	B6	01	00	0C							
B1	E1	F1	B3	J2								B1	E1	F1	B3	J2							
		00	00	00										00	00	00							
D1	D2	D3	C2	Z6								D1	D2	D3	C2	Z6							
		00	00	00										00	00	00							
H1	H2	H3	G1	Z7								H1	H2	H3	G1	Z7							
		00	02	01										00	02	01							
R2	K1	K2	F2									R2	K1	K2	F2								
		00	00	00										00	00	00							
D4	D5	D6	H4									D4	D5	D6	H4								
		00	00	00										00	00	00							
D7	D8	D9	Z3									D7	D8	D9	Z3								
		00	00	00										00	00	00							
D10	D11	D12	Z4									D10	D11	D12	Z4								
		00	00	00										00	00	00							
S1	Z2	E2	N1									S1	Z2	E2	N1								
		00	00											00	00								

## KEY ISDN FEATURES

The NetBlazer lets you test and troubleshoot North American or European ISDN PRI configurations. It offers best-in-class ISDN PRI testing by allowing field technicians to call one or all 24 DS1 or 31 E1 PRI channels. Once connected, the user can go channel by channel to perform a BER test on individual or all channels as well as talk and listen via a headset.

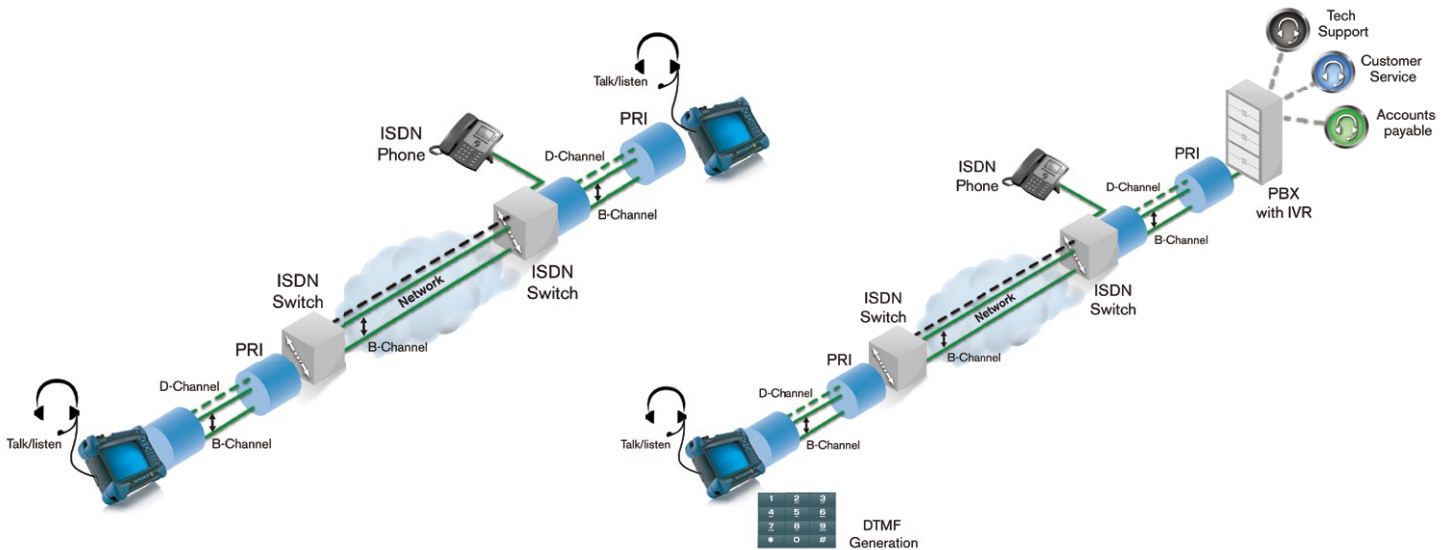

### Talk? Listen? Inject DTMF?

With one click, field technicians can talk and listen with simplicity—no need for a clumsy butt set. The FTB-1 platform allows the use of a handy, lightweight headset, which can be controlled via software to inject DTMF tones or speaker and microphone levels.

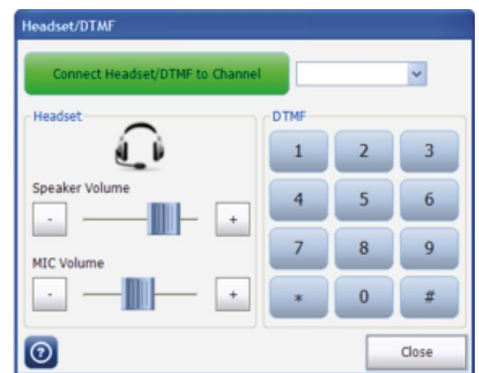

### Who's Calling? What Type of Calls?

As the calls come in or leave the ISDN primary rate interface, the summary results screen shows a crystal-clear analysis with its own unique call monitoring grid. With one glance, users see all call information: types of calls, stats such as idle, voice, 3.1 kHz, ringing, alerts, In Error, BER, pass or fail.

1 Idle	2 Voice	3 Alerting	4 3.1 kHz	5 Idle	6 Voice
7 Idle	8 Ringing	9 Ringing	10 3.1 kHz	11 No Alarm	12 Idle
13 Idle	14 Voice	15 Voice	17 No Alarm	18 Bit Error	19 Voice
20 Idle	21 No Alarm	22 Idle	23 Bit Error	24 No Alarm	25 3.1 kHz
26 Idle	27 Idle	28 Idle	29 No Alarm	30 Pattern	31 Voice

### Centralized Control

As with all NetBlazer modules, field technicians have complete control at their fingertips at all times, whether it's a phone book, headset activation, DTMF injection, error injection, report generation, or save and load configurations. These utilities are always a finger's touch away from activation.

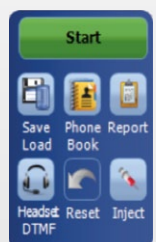

## Key Ethernet Features

### Intelligent Network Discovery Mode

Using the NetBlazer or the FTB-860x test set, you can single-handedly scan the network and connect to any available EXFO datacom remote tester. Simply select the unit to be tested and choose whether you want traffic to be looped back via Smart Loopback or Dual Test Set for simultaneous bidirectional EtherSAM and RFC 2544 results. No more need for an additional technician at the far end to relay critical information—these NetBlazer products take care of it all.

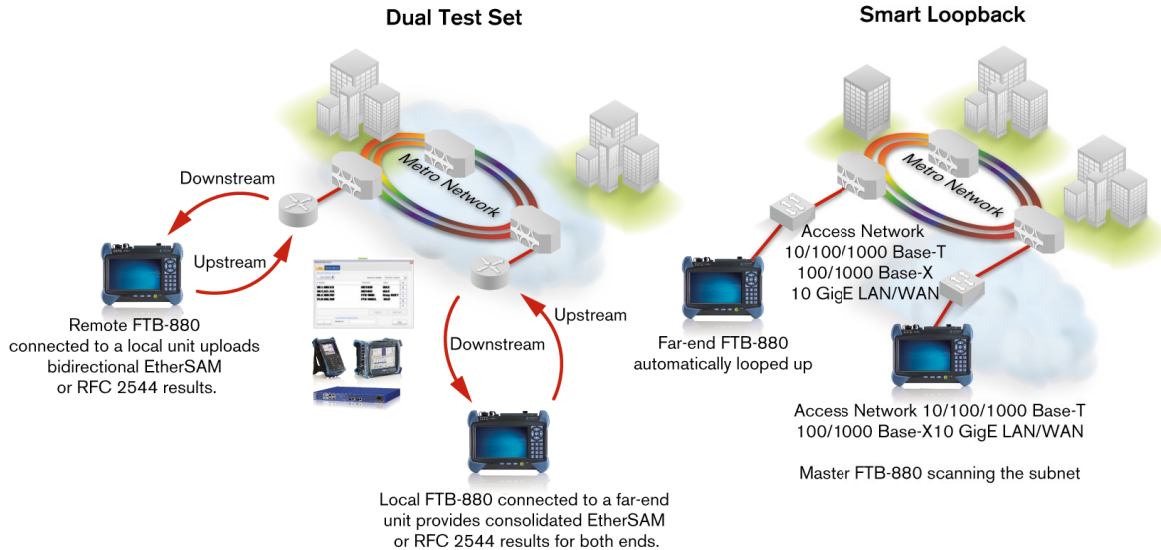

### Smart Loopback Flexibility

The Smart Loopback functionality has been enhanced to offer five distinct loopback modes. Whether you are looking to pinpoint loopback traffic from a UDP or TCP layer, or all the way down to a completely promiscuous mode (Transparent Loopback mode), the NetBlazer or the FTB-860x has the flexibility to adjust for all unique loopback situations.

### Dual-Port and Through Mode Testing

The NetBlazer Series is equipped for both Through mode or dual-port testing. Through mode allows traffic to pass through either of the NetBlazer's two electrical or optical ports for in-service troubleshooting of live traffic between the carrier/service provider network and the customer's network. This allows technicians to access circuits under test without the need for a splitter. With dual-port testing, the technician can use a single NetBlazer module to launch the test and perform the loopback. With two NetBlazer Series modules, the dual-port feature also enables users to run two simultaneous tests to maximize time and efficiency.

### VLAN/MPLS

Today's networks are expected to deliver high performance. To match such high expectations, service providers must rely on various mechanisms, such as Ethernet tagging, encapsulation and labeling. Thanks to these additions, service providers can enhance security, scalability, reliability and performance. The NetBlazer Series supports virtual local area network (VLAN) tags, Q-in-Q VLAN tags and multiprotocol label switching (MPLS).

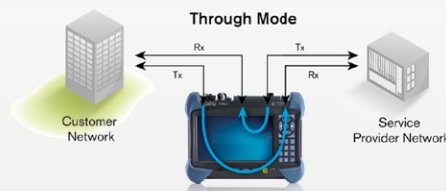

### Dual Port Modes



## ETHERSAM: THE NEW STANDARD IN ETHERNET TESTING

RFC 2544 used to be the most widespread Ethernet testing methodology. However, it was designed for network-device testing in the lab, not for service testing in the field. ITU-T Y.1564 is the new standard for turning up and troubleshooting Carrier Ethernet services. It has a number of advantages over RFC 2544, including validation of critical SLA criteria, such as packet jitter and QoS measurements. This methodology is also significantly faster, therefore saving time and resources while optimizing QoS.

EXFO's EtherSAM test suite—based on the ITU-T Y.1564 Ethernet service activation methodology—provides comprehensive field testing for mobile backhaul and commercial services.

Contrary to other methodologies, EtherSAM supports new multiservice offerings. It can simulate all types of services that will run on the network and simultaneously qualify all key SLA parameters for each of these services. Moreover, it validates the QoS mechanisms provisioned in the network to prioritize the different service types, resulting in better troubleshooting, more accurate validation and much faster deployment. EtherSAM is comprised of two phases, the service configuration test and the service performance test.

### Service Configuration Test

The service configuration test consists in sequentially testing each service in order to validate that each is properly provisioned and that all specific KPIs or SLA parameters are met. A ramp test and a burst test are performed to verify the committed information rate (CIR), excess information rate (EIR), committed burst size (CBS) and excess burst size (EBS).

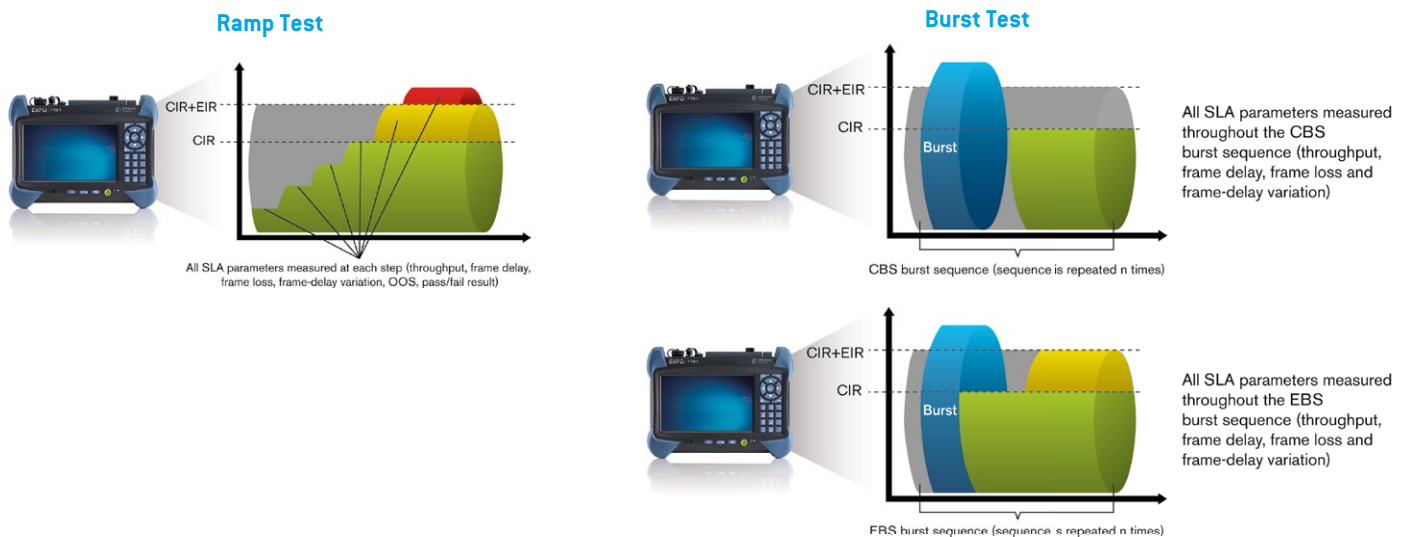

### Service Performance Test

Once the configuration of each individual service is validated, the service performance test simultaneously validates the quality of all the services over time.





### EtherSAM Bidirectional Results

EXFO's EtherSAM approach proves even more powerful as it executes the complete ITU-T Y.1564 test with bidirectional measurements. Key SLA parameters are measured independently in each test direction, thus providing 100% first-time-right service activation—the highest level of confidence in service testing.

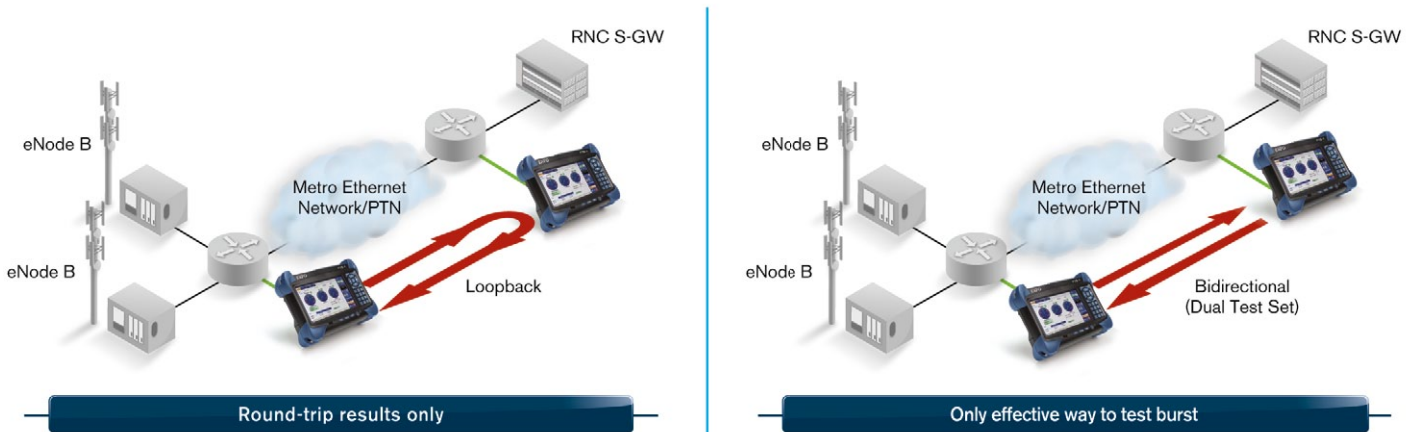

### FTTA TESTING

The times are constantly changing and the telecommunications industry is rapidly evolving to keep pace. This is especially true when it comes to mobile network operators (MNOs) and the delivery of their services. Bandwidth-hogging applications like high-definition video, media-rich content and interactive mobile applications are being introduced at an ever-increasing rate. The wireless infrastructure has to be modernized to keep up with this continuous, high bandwidth growth and to minimize latency. To meet these expectations, MNOs are now switching their infrastructures from legacy “copper to the antenna” to fiber-to-the-antenna (FTTA). With the introduction of FTFA, MNOs can offer better performance with lower base-station costs. One key component of evolving to FTFA requires the addition of either the common public radio interface (CPRI) or the open base station architecture initiative (OBSAI).

Incorporating either CPRI or OBSAI, the actual base stations can be located in much less challenging locations, where size, climate and availability of power are much more easily managed. In addition, wireless network providers can maximize the base-station output by having multiple antennas per offsite base station.

With the NetBlazer Series of modules, field technicians can perform FTFA tests (CPRI or OBSAI). OBSAI testing is supported by 3.1 Gbit/s, and CPRI covers rates from 1.2 Gbit/s all the way up to 9.8 Gbit/s. The NetBlazer modules can perform a BER test that validates the fiber from the remote base station all the way to the remote radio head.

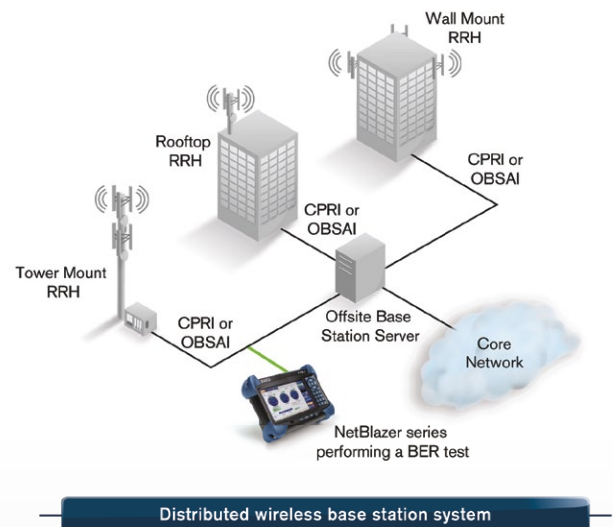

### Traffic Generation and Monitoring

The Netblazer Series surpasses the multistream offerings of typical handheld Ethernet testing devices. 16 streams of traffic can be configured by a technician to test just about any frame format: Ethernet II, 802.3 SNAP, IPv4, IPv6, 3 levels of VLANs, MPLS, UDP and TCP. Each stream has an analog visual gauge and user-definable pass/fail thresholds that instantly show whether the test traffic is in or out of the expected ranges of the service level agreement.

### Layer-2 Transparency Testing

The NetBlazer uses a new virtual frame display that allows field techs to easily configure multiple streams and their parameters, including the ability to modify the source MAC address, Ethertype, etc. This makes it possible to test layer-2 protocols such as CDP, VTP and LLDP. For added simplification, there are also predefined factory configurations capable of automatically loading up to ten layer-2 protocols simultaneously.



### EXacTCP

The transmission control protocol (TCP) ensures that data packets are reliably transmitted by the host to the destination. Applications such as hypertext transfer protocol (HTTP), e-mail or file transfer protocol (FTP) rely on TCP as their delivery mechanism. Those deploying such applications expect not only physical- and link-level SLAs from their service providers, but assurance that their TCP traffic requirements will be supported across the network. EXacTCP, the TCP throughput feature available in the NetBlazer Series, is based on RFC 6349. It provides accurate measurements of TCP metrics, such as throughput, round-trip time (RTT) and optimal window size.

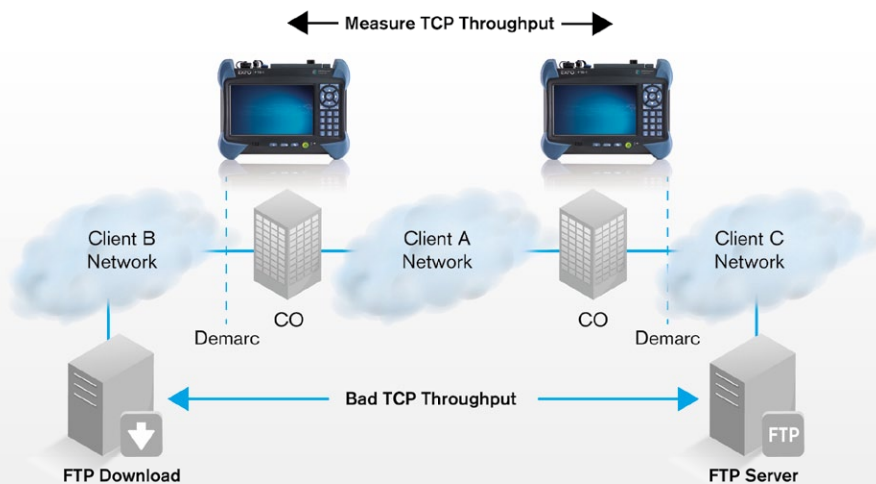

### Carrier Ethernet OAM

Ever since the introduction of metro Ethernet networks, there has been a need to ensure “five nines” level of availability, reliability and 50-millisecond recovery times from failures. Just as PDH, TDM and SONET/SDH, OAM has become a crucial network component that has enabled the same quality for carrier-class Ethernet.

The NetBlazer Series offers a new application that validates the mechanics of the service operation, administration and maintenance (S-OAM) tools, which covers Y.1731, 802.1ag, G.8113.1 (MPLS-TP) and MEF modes. The features of this application include continuity check generation and monitoring, loopback testing, frame loss, synthetic loss and frame delay. There is also an S-OAM link trace and responder.

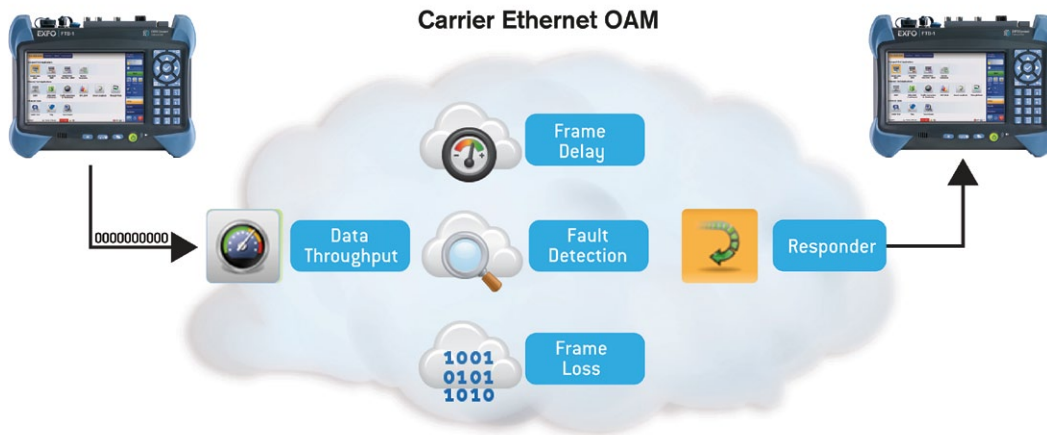

### Packet Capture

The capturing power of EXFO’s NetBlazer Series extends far beyond basic capabilities. The NetBlazer Series adds extra features and functionalities to boost test cycle efficiency and provides more value. Its packet capture tool offers comprehensive filtering, triggering and truncation methods to target specific traffic and quickly pinpoint issues in the lab and in the field.

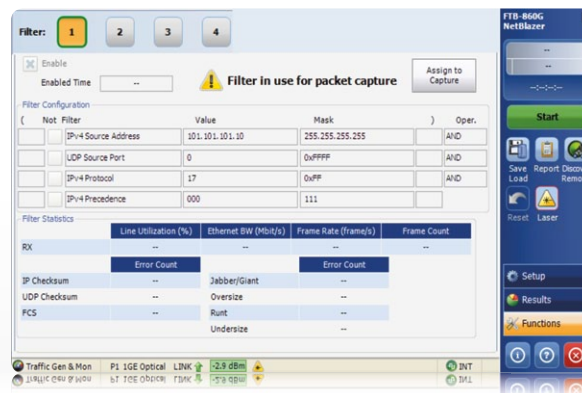

### Advanced Traffic Filtering

In some cases, troubleshooting only concerns a particular traffic flow. The advanced traffic-filtering capability of the NetBlazer Series allows you to restrict traffic by using up to four matching fields and operands (and, or, not). A complete set of triggers is available, such as MAC, IP and TCP/UDP fields, as well as VLAN, MPLS fields.

## EFFICIENTLY ASSESSING PERFORMANCE OF FIBRE CHANNEL SERVICES

The NetBlazer Series modules provide comprehensive testing capabilities for Fibre Channel network deployments, supporting multiple Fibre Channel interfaces.

### APPLICATIONS

Since most storage area networks (SANs) cover large distances and because Fibre Channel has stringent performance requirements, it is imperative to test at each phase of network deployment to ensure appropriate service levels. EXFO's NetBlazer Series modules provide full wire-speed traffic generation at the FC-2 layer, which allows for BER testing for link integrity measurements. The NetBlazer Series also supports latency, buffer-to-buffer credit measurements for optimization as well as login capabilities.

#### Latency

Transmission of frames in a network is not instantaneous, and is subject to multiple delays caused by the propagation delay in the fiber and the processing time inside each piece of network equipment. Latency is the total accumulation of delays between two endpoints. Some applications, such as VoIP, video and storage area networks, are very sensitive to excess latency.

It is therefore critical for service providers to properly characterize network latency when offering Fibre Channel services. The NetBlazer Series modules estimate buffer-to-buffer credit value requirements from the performed latency measurement.

#### Buffer-to-Buffer Credit Estimation

In order to regulate traffic flow and congestion, Fibre Channel ports use "buffers" to temporarily store frames. The number of frames a port can store is referred to as a "buffer credit". Each time a frame is received by a port, an acknowledgement frame is sent. The buffer-to-buffer credit threshold refers to the amount of frames a port can transmit without receiving a single acknowledgement.

This is a crucial configuration parameter for optimal network performance. Usually, network administrators calculate the value by taking the traveled distance and the data rate into consideration; however, since latency issues are not considered, poor accuracy is to be expected. The NetBlazer Series modules are capable of estimating buffer credit values with respect to latency by calculating the distance according to the round-trip latency time. This value can then be used by network administrators to optimize the network configuration.

#### Login Testing

Most new-generation transport devices (xWDM or SONET/SDH mux) supporting Fibre Channel are no longer fully transparent; they also have increased built-in intelligence, acting more as Fibre Channel switches. With switch fabric login ability, the NetBlazer Series modules support connections to a remote location through a fabric or semitransparent network.

The login process not only permits the unit to connect through a fabric, but it also exchanges some of the basic port characteristics (such as buffer-to-buffer credit and class of service) in order to efficiently transport the traffic through the network.

The login feature allows automatic detection of port/fabric login, login status (successful login, in progress, failure and logout) and response to remote buffer-to-buffer advertised credit.

COMPLETE SUITE OF FIBRE CHANNEL INTERFACES		
Interface	Signal Rate (Gbit/s)	Data Rate (MB/s)
1X	1.0	100
2X	2.1	200
4X	4.2	400
8X	8.5	800
10X	10.5	1200

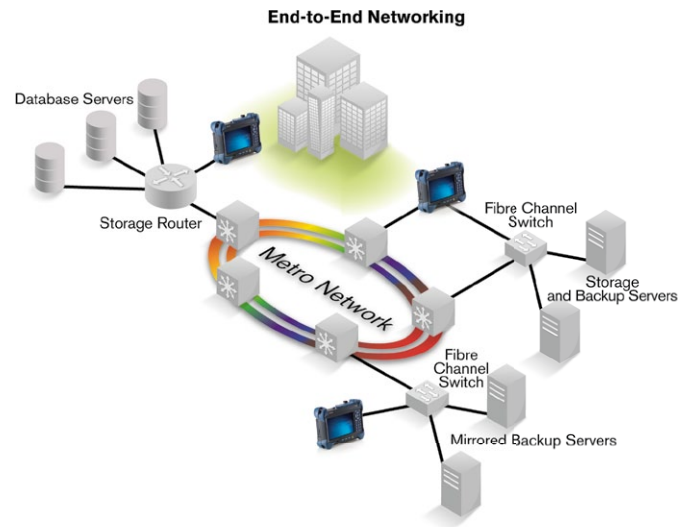

*Thanks to end-to-end network testing capabilities, EXFO's NetBlazer enables fast deployment and configuration of Fibre Channel networks. Communication between the transport network, interconnection devices and end nodes can be validated with features such as BER testing, latency measurement, buffer-to-buffer credit estimation and port login capabilities.*





**EXFO TFv**  
Test Function Virtualization

### EXFO TFv

EXFO TFv—Test Function Virtualization is a cloud-based suite of defined offerings for service providers who are looking to scale their testing requirements to their specific needs. Under the EXFO TFv umbrella are FTB Anywhere floating licenses, and the newly launched FTB OnDemand time-based software licenses.

#### FTB Anywhere: Floating Test Licenses

FTB Anywhere is an EXFO Connect-enabled offering that allows FTB platform users to share floating test licenses and get the required functionality—anywhere, anytime. In short, the customer owns the software licenses and can share them between FTB platforms.

#### FTB OnDemand: Time-Based Software Licenses

FTB OnDemand allows customers to activate time-based software licenses covering a wide range of test functionalities (e.g., 100G testing) to match their exact needs. FTB OnDemand enables users to obtain a license for specific test for a specific module for a specific period of time. FTB OnDemand is available for a number of best-in-class EXFO test modules. For a complete list of all the available modules, visit our FTB OnDemand Web page.



**AUTOMATED ASSET MANAGEMENT. PUSH TEST DATA IN THE CLOUD. GET CONNECTED.**

EXFO Connect pushes and stores test equipment and test data content automatically in the cloud, allowing you to streamline test operation from build-out to maintenance.

### EXPERT TEST TOOLS ON THE FTB-1 PLATFORM

EXpert Test Tools is a series of platform-based software testing tools that enhance the value of the FTB-1 platform, providing additional testing capabilities without the need for additional modules or units.

Expert TEST TOOLS	
<b>EXpert</b> <b>VoIP</b> TEST TOOLS	<p>The EXpert VoIP Tools generate a voice-over-IP call directly from the test platform to validate performance during service turn-up and troubleshooting.</p> <ul style="list-style-type: none"> <li>• Supports a wide range of signaling protocols, including SIP, SCCP, H.248/Megaco and H.323</li> <li>• Supports MOS and R-factor quality metrics</li> <li>• Simplifies testing with configurable pass/fail thresholds and RTP metrics</li> </ul>
<b>EXpert</b> <b>IP</b> TEST TOOLS	<p>The EXpert IP Tools integrate six commonly used datacom test tools into one platform-based application to ensure that field technicians are prepared for a wide range of testing needs.</p> <ul style="list-style-type: none"> <li>• Rapidly perform debugging sequences with VLAN scan and LAN discovery</li> <li>• Validate end-to-end ping and traceroute</li> <li>• Verify FTP performance and HTTP availability</li> </ul>
<b>EXpert</b> <b>IPTV</b> TEST TOOLS	<p>This powerful IPTV quality assessment solution enables set-top-box emulation and passive monitoring of IPTV streams, allowing quick and easy pass/fail verification of IPTV installations.</p> <ul style="list-style-type: none"> <li>• Real-time video preview</li> <li>• Analyzes up to 10 video streams</li> <li>• Comprehensive QoS and QoE metrics, including MOS score</li> </ul>



## SPECIFICATIONS

SFP ETHERNET OPTICAL INTERFACES							
	Two ports: 100M and GigE						
Available wavelengths (nm)	850, 1310 and 1550						
Model	FTB-85910	FTB-85911	FTB-8590	FTB-8190	FTB-8192	FTB-8596	FTB-8597
Transceiver type	<b>100 Base-FX</b>	<b>100 Base-LX</b>	<b>1000 Base-SX</b>	<b>1000 Base-LX</b>	<b>1000 Base-ZX</b>	<b>1000 Base-BX10-D</b>	<b>1000 Base-BX10-U</b>
Wavelength (nm)	1310	1310	850	1310	1550	Tx: 1490 Rx: 1310	Tx: 1310 Rx: 1490
Tx level (dBm)	-20 to -15	-15 to -8	-9 to -2.5	-5 to 0	-2 to 3	-9 to -3	-9 to -3
Rx level sensitivity (dBm)	-31	-28	-18	-22	-30	-20	-20
Maximum reach	2 km	15 km	500 m	10 km	80 km	10 km	10 km
Transmission bit rate (Gbit/s)	0.125	0.125	1.25	1.25	1.25	1.25	1.25
Reception bit rate (Gbit/s)	0.125	0.125	1.25	1.25	1.25	1.25	1.25
Tx operational wavelength range (nm)	1280 to 1380	1261 to 1360	830 to 860	1270 to 1360	1500 to 1580	1480 to 1500	1260 to 1360
Measurement accuracy (uncertainty)							
Frequency (ppm)	±4.6	±4.6	±4.6	±4.6	±4.6	±4.6	±4.6
Optical power (dB)	±2	±2	±2	±2	±2	±2	±2
Maximum Rx before damage (dBm) <sup>a</sup>	3	3	6	6	6	6	6
Jitter compliance	ANSI X3.166	IEEE 802.3	IEEE 802.3	IEEE 802.3		IEEE 802.3ah	IEEE 802.3ah
Ethernet classification	ANSI X3.166	IEEE 802.3	IEEE 802.3	IEEE 802.3		IEEE 802.3ah	IEEE 802.3ah
Laser type	LED	FP	VCSSEL	DFB	DFB	DFB	FP
Eye safety	Class 1	Class 1	Class 1	Class 1	Class 1	Class 1	Class 1
Connector <sup>b</sup>	LC	LC	LC	LC	LC	LC	LC

SFP SONET/SDH AND OTN OPTICAL INTERFACES												
Transceiver type	OC-3/STM-1				OC-12/STM-4				OC-48/STM-16/OTU1			
Reach and wavelength	15 km; 1310 nm	40 km; 1310 nm	40 km; 1550 nm	80 km; 1550 nm	15 km; 1310 nm	40 km; 1310 nm	40 km; 1550 nm	80 km; 1550 nm	15 km; 1310 nm	40 km; 1310 nm	40 km; 1550 nm	80 km; 1550 nm
Model	FTB-8190	FTB-8191	FTB-8193	FTB-8192	FTB-8190	FTB-8191	FTB-8193	FTB-8192	FTB-8190	FTB-8191	FTB-8193	FTB-8192
Tx level (dBm)	-5 to 0	-2 to 3	-5 to 0	-2 to 3	-5 to 0	-2 to 3	-5 to 0	-2 to 3	-5 to 0	-2 to 3	-5 to 0	-2 to 3
Rx operating range (dBm)	-23 to -10	-30 to -15	-23 to -10	-30 to -15	-22 to 0	-27 to -9	-22 to 0	-29 to -9	-18 to 0	-27 to -9	-18 to 0	-28 to -9
Transmit bit rate	155.52 Mbit/s ± 4.6 ppm				622.08 Mbit/s ± 4.6 ppm				2.48832 Gbit/s ± 4.6 ppm 2.66606 Gbit/s ± 4.6 ppm			
Frequency offset generation (ppm)	±50				±50				±50			
Receive bit rate	155.52 Mbit/s ± 100 ppm				622.08 Mbit/s ± 100 ppm				2.48832 Gbit/s ± 100 ppm 2.66606 Gbit/s ± 100 ppm (OTU1)			
Operational wavelength range	1261 to 1360 nm	1263 to 1360 nm	1430 to 1580 nm	1480 to 1580 nm	1270 to 1360 nm	1280 to 1335 nm	1430 to 1580 nm	1480 to 1580 nm	1260 to 1360 nm	1280 to 1335 nm	1430 to 1580 nm	1500 to 1580 nm
Spectral width	1 nm (-20 dB)				1 nm (-20 dB)				1 nm (-20 dB)			
Measurement accuracy (uncertainty)												
Frequency (ppm)	±4.6				±4.6				±4.6			
Optical power (dB)	±2				±2				±2			
Maximum Rx before damage (dBm) <sup>a</sup>	3				3				3			
Jitter compliance	GR-253 (SONET) G.958 (SDH)				GR-253 (SONET) G.958 (SDH)				GR-253 (SONET) G.958 (SDH) G.8251 (OTN)			
Line coding	NRZ				NRZ				NRZ			
Eye safety	Class 1				Class 1				Class 1			
Connector <sup>b</sup>	LC				LC				LC			

### Notes

- In order not to exceed the maximum receiver power level before damage, an attenuator must be used.
- External adaptors can be used for other types of connectors.
- SFP compliance: The NetBlazer selected SFP shall meet the requirements stated in the "Small Form-Factor Pluggable (SFP) Transceiver Multisource Agreement (MSA)". The NetBlazer selected SFP shall meet the requirements stated in the "Specification for Diagnostic Monitoring Interface for Optical Xcvrs".

SFP+ ETHERNET OPTICAL INTERFACES			
Transceiver type	10G Base-SR/SW	10G Base-LR/LW	10G Base-ER/EW
Wavelength (nm)	850	1310	1550
Model	FTB-8690	FTB-8691	FTB-8692
Tx level (dBm)	-5 to -1	-8 to 0.5	-4.7 to 4.0
Rx level sensitivity (dBm)	-11.1	-12.6	-14.1
Maximum reach	300 m	10 km	40 km
Tx bit rate (Gbit/s)	9.95 to 10.3	9.95 to 10.3	9.95 to 10.3
Rx bit rate (Gbit/s)	9.95 to 10.3	9.95 to 10.3	9.95 to 10.3
Tx operational wavelength range (nm)	840 to 860	1260 to 1355	1530 to 1565
Measurement accuracy (uncertainty) Frequency (ppm)	±4.6	±4.6	±4.6
Maximum Rx before damage (dBm) <sup>a</sup>	6	5	5
Jitter compliance	IEEE 802.3ae	IEEE 802.3ae	IEEE 802.3ae
Laser type	VCSEL	DFB	CML
Eye safety	Class 1	Class 1	Class 1
Connector <sup>b</sup>	LC	LC	LC

SFP+ 10G SONET/SDH AND OTN OPTICAL INTERFACES			
Transceiver type	OC-192/STM-64/OTU2	OC-192/STM-64/OTU2	OC-192/STM-64/OTU2
Wavelength (nm)	1310	1550	1550
Model	FTB-8693	FTB-8694	FTB-8695
Tx level (dBm)	-6 to -1	-1 to 2	0 to 4
Rx level sensitivity (dBm)	-11 to 0.5	-14 to -1	-24 to -7
Maximum reach	10 km	40 km	80 km
Transmission bit rate (Gbit/s)	9.9532 ± 4.6 ppm 10.7092 ± 4.6 ppm (OTU2) 11.0491 ± 4.6 ppm (OTU1e) 11.0957 ± 4.6 ppm (OTU2e) 11.2701 ± 4.6 ppm (OTU1f) 11.3176 ± 4.6 ppm (OTU2f)	9.9532 ± 4.6 ppm 10.7092 ± 4.6 ppm (OTU2) 11.0491 ± 4.6 ppm (OTU1e) 11.0957 ± 4.6 ppm (OTU2e) 11.2701 ± 4.6 ppm (OTU1f) 11.3176 ± 4.6 ppm (OTU2f)	9.9532 ± 4.6 ppm 10.7092 ± 4.6 ppm (OTU2) 11.0491 ± 4.6 ppm (OTU1e) 11.0957 ± 4.6 ppm (OTU2e) 11.2701 ± 4.6 ppm (OTU1f) 11.3176 ± 4.6 ppm (OTU2f)
Frequency offset generation (ppm)	±50	±50	±50
Reception bit rate (Gbit/s)	9.9532 ± 100 ppm 10.7092 ± 100 ppm (OTU2) 11.0491 ± 120 ppm (OTU1e) 11.0957 ± 120 ppm (OTU2e) 11.2701 ± 120 ppm (OTU1f) 11.3176 ± 120 ppm (OTU2f)	9.9532 ± 100 ppm 10.7092 ± 100 ppm (OTU2) 11.0491 ± 120 ppm (OTU1e) 11.0957 ± 120 ppm (OTU2e) 11.2701 ± 120 ppm (OTU1f) 11.3176 ± 120 ppm (OTU2f)	9.9532 ± 100 ppm 10.7092 ± 100 ppm (OTU2) 11.0491 ± 120 ppm (OTU1e) 11.0957 ± 120 ppm (OTU2e) 11.2701 ± 120 ppm (OTU1f) 11.3176 ± 120 ppm (OTU2f)
Tx operational wavelength range (nm)	1260 to 1355	1530 to 1565	1530 to 1565
Measurement accuracy (uncertainty) Frequency (ppm) Optical power (dB)	±4.6 ±2	±4.6 ±2	±4.6 ±2
Maximum Rx before damage (dBm) <sup>a</sup>	5	5	3
Jitter compliance	GR-253 (SONET) G.825 (SDH) G.8251 (OTN)	GR-253 (SONET) G.825 (SDH) G.8251 (OTN)	GR-253 (SONET) G.825 (SDH) G.8251 (OTN)
Eye safety	Class 1	Class 1	Class 1
Connector <sup>b</sup>	LC	LC	LC

**Notes**

- a. In order not to exceed the maximum receiver power level before damage, an attenuator must be used.
- b. External adaptors can be used for other types of connectors.
- c. SFP+ compliance: The NetBlazer selected SFP+ shall meet the requirements stated in the SFP-8431 "Enhanced Small Form-Factor Pluggable Module SFP+" Transceiver Multisource Agreement (MSA)". The NetBlazer selected SFP+ shall meet the requirements stated in the "Specification for Diagnostic Monitoring Interface for Optical Xcvrs".

ELECTRICAL ETHERNET INTERFACES			
	Two ports: 10/100 Base-T half/full duplex, 1000 Base-T full duplex Automatic or manual detection of straight/crossover cable		
Transceiver type	<b>10 Base-T</b>	<b>100 Base-TX</b>	<b>1000 Base-T</b>
Tx bit rate	10 Mbit/s	125 Mbit/s	1 Gbit/s
Tx accuracy (uncertainty) (ppm)	±4.6	±4.6	±4.6
Rx bit rate	10 Mbit/s	125 Mbit/s	1 Gbit/s
Rx measurement accuracy (uncertainty) (ppm)		±4.6	±4.6
Duplex mode	Half and full duplex	Half and full duplex	Full duplex
Jitter compliance	IEEE 802.3	IEEE 802.3	IEEE 802.3
Connector	RJ-45	RJ-45	RJ-45
Maximum reach (m)	100	100	100

DSN/PDH AND SONET/SDH ELECTRICAL INTERFACES										
Transceiver type	DS1	E1/2M		E3/34M	DS3/45M		STS-1e/STM-0e/52M	E4/140M	STS-3e/STM-1e/155M	
Tx pulse amplitude	2.4 to 3.6 V	3.0 V	2.37 V	1.0 ±0.1 V	0.36 to 0.85 V			1.0 ±0.1 Vpp	0.5 V	
Tx pulse mask	GR-499 Figure 9.5	G.703 Figure 15	G.703 Figure 15	G.703 Figure 17	DS-3 GR-499 Figure 9-8	45M G.703 Figure 14	GR-253 Figure 4-10/4-11	G.703 Figure 18/19	STS-3e GR-253 Figure 4-12, 4-13, 4-14	STM-1e/155M G.703 Figure 22 and 23
Tx LBO preamplification	0-133 ft 133-266 ft 266-399 ft 399-533 ft 533-655 ft				0 to 225 ft 225 to 450 ft		0 to 225 ft 225 to 450 ft		0 to 225 ft	
Cable simulation	-22.5 dB -15.0 dB -7.5 dB 0 dB				450 to 900 (927) ft		450 to 900 (927) ft			
Rx level sensitivity	For 772 kHz: TERM: ≤26 dB (cable loss only) at 0 dBd <sub>sx</sub> Tx DSX-MON: ≤26 dB (20 dB resistive loss + cable loss ≤ 6 dB) Bridge: ≤6 dB (cable loss only)	For 1024 kHz: TERM: ≤6 dB (cable loss only) MON: ≤26 dB (20 dB resistive loss + cable loss ≤ 6 dB) Bridge: ≤6 dB (cable loss only)	For 1024 kHz: TERM: ≤6 dB (cable loss only) MON: ≤26 dB (20 dB resistive loss + cable loss ≤ 6 dB) Bridge: ≤6 dB (cable loss only)	For 17.184 MHz: TERM: ≤12 dB (coaxial cable loss only) MON: ≤26 dB (20 dB resistive loss + cable loss ≤ 6 dB)	For 22.368 MHz: TERM: ≤10 dB (cable loss only) DSX-MON: ≤26.5 dB (21.5 dB resistive loss + cable loss ≤ 5 dB)	For 25.92 MHz: TERM: ≤10 dB (cable loss only) MON: ≤25 dB (20 dB resistive loss + cable loss ≤ 5 dB)	For 70 MHz: TERM: ≤12 dB (coaxial cable loss only) MON: ≤26 dB (20 dB resistive loss + cable loss ≤ 6 dB)	For 78 MHz: TERM: ≤12 dB (coaxial cable loss only) MON: ≤26 dB (20 dB resistive loss + cable loss ≤ 6 dB)		
Transmit bit rate	1.544 Mbit/s ±4.6 ppm	2.048 Mbit/s ±4.6 ppm	2.048 Mbit/s ±4.6 ppm	34.368 Mbit/s ±4.6 ppm	44.736 Mbit/s ±4.6 ppm	51.84 Mbit/s ±4.6 ppm	139.264 Mbit/s ±4.6 ppm	155.52 Mbit/s ±4.6 ppm		
Frequency offset generation	1.544 Mbit/s ±140 ppm	2.048 Mbit/s ±70 ppm	2.048 Mbit/s ±70 ppm	34.368 Mbit/s ±50 ppm	44.736 Mbit/s ±50 ppm	51.84 Mbit/s ±50 ppm	139.264 Mbit/s ±50 ppm	155.52 Mbit/s ±50 ppm		
Receive bit rate	1.544 Mbit/s ±140 ppm	2.048 Mbit/s ±100 ppm	2.048 Mbit/s ±100 ppm	34.368 Mbit/s ±100 ppm	44.736 Mbit/s ±100 ppm	51.84 Mbit/s ±100 ppm	139.264 Mbit/s ±100 ppm	155.52 Mbit/s ±100 ppm		
Measurement accuracy (uncertainty)										
Frequency (ppm)	±4.6	±4.6	±4.6	±4.6	±4.6	±4.6	±4.6	±4.6		
Electrical power (dB)	±1.5	±1.5	±1.5	±1.5	±1.5	±1.5	±1.5	±1.5		
Peak-to-peak voltage	±10 % down to 500 mVpp	±10 % down to 500 mVpp	±10 % down to 500 mVpp	±10 % down to 500 mVpp	±10 % down to 200 mVpp	±10 % down to 200 mVpp	±10 % down to 200 mVpp	±10 % down to 200 mVpp		
Intrinsic jitter (Tx)	ANSI T1.403 section 6.3 GR-499 section 7.3	G.823 section 5.1	G.823 section 5.1	G.823 section 5.1 G.751 section 2.3	GR-499 section 7.3 (categories I and II)	GR-253 section 5.6.2.2 (category II)	G.823 section 5.1	G.825 section 5.1 GR-253 section 5.6.2.2		
Input jitter tolerance	AT&T PUB 62411 GR-499 section 7.3	G.823 section 7.1	G.823 section 7.1	G.823 section 7.1	GR-499 section 7.3 (categories I and II)	GR-253 section 5.6.2.2 (category II)	G.823 section 7.1 G.751 section 3.3	G.825 section 5.2 GR-253 section 5.6.2.3		
Line coding	AMI and B8ZS	AMI and HDB3	AMI and HDB3	HDB3	B3ZS	B3ZS	CM1	CM1		
Input impedance (resistive termination)	100 ohms ±5 %, balanced	120 ohms ±5 %, balanced	75 ohms ±5 %, unbalanced	75 ohms ±5 %, unbalanced	75 ohms ±5 %, unbalanced	75 ohms ±5 %, unbalanced	75 ohms ±10 %, unbalanced	75 ohms ±5 %, unbalanced		
Connector type	BANTAM and RJ-48C	BANTAM and RJ-48C	BNC	BNC	BNC	BNC	BNC	BNC		



### SFP FIBRE CHANNEL INTERFACES

#### FC-1x/2x/4x

Wavelength (nm)	850	1310	1310	1550
Model	FTB-85912	FTB-85913	FTB-85914	FTB-85915
Tx level (dBm)	-9 to -2.5	-8.4 to -3	0 to 5	1 to 5
Rx level sensitivity (dBm)	-15 at FC-4 -18 at FC-2 -20 at FC-1	-18 at FC-4 -21 at FC-2 -22 at FC-1	-18 at FC-4 -21 at FC-2 -22 at FC-1	-16.5 at FC-4 -20.5 at FC-2 -22 at FC-1
Maximum reach (FC-1)	500 m on 50/125 µm MMF 300 m on 62.5/125 µm MMF	4 km	30 km	40 km
Transmission bit rate (Gbit/s)	1.06/2.125/4.25	1.06/2.125/4.25	1.06/2.125/4.25	1.06/2.125/4.25
Reception bit rate (Gbit/s)	1.06/2.125/4.25	1.06/2.125/4.25	1.06/2.125/4.25	1.06/2.125/4.25
Tx operational wavelength range (nm)	830 to 860	1260 to 1350	1285 to 1345	1544.5 to 1557.5
Measurement accuracy (uncertainty)				
Frequency (ppm)	±4.6	±4.6	±4.6	±4.6
Optical power (dB)	±2	±2	±2	±2
Max Rx before damage (dBm)	3	3	3	3
Jitter compliance	ANSI FC-PI-2	ANSI FC-PI-2	ANSI FC-PI-2	ANSI FC-PI-2
FC classification	ANSI FC-PI-2	ANSI FC-PI-2	ANSI FC-PI-2	ANSI FC-PI-2
Laser type	VCSEL	Fabry-Perot	DFB	DFB
Eye safety	Class 1	Class 1	Class 1	Class 1
Connector	LC	LC	LC	LC

### SFP+ FIBRE CHANNEL INTERFACES

#### FC-8x/10x

Wavelength (nm)	850	850	1310	1550	1550
Model	FTB-8696	FTB-8690	FTB-8693	FTB-8694	FTB-8695
Tx level (dBm)	-8.2 to -2	-5 to -1	-6 to -1	-1 to 2	0 to 4
Rx level sensitivity (dBm)	-11.1 to 0	-11.1 to 0.5	-14.4 to 0.5	-14 to -1	-24 to -7
Maximum reach	150 m on OM3 MMF	300 m on OM3 MMF	10 km	40 km	80 km
Transmission bit rate (Gbit/s)	8.5	10.5	8.5/10.5	8.5/10.5	8.5/10.5
Reception bit rate (Gbit/s)	8.5	10.5	8.5/10.5	8.5/10.5	8.5/10.5
Tx operational wavelength range (nm)	840-860	840-860	1260 to 1355	1530 to 1565	1530 to 1565
Measurement accuracy (uncertainty)					
Frequency (ppm)	±4.6	±4.6	±4.6	±4.6	±4.6
Optical power (dB)	±2	±2	±2	±2	±2
Max Rx before damage (dBm)	+5	+5	+5	+5	+3
Jitter compliance	ANSI FC-PI-3	ANSI FC-PI-3	ANSI FC-PI-3	ANSI FC-PI-3	ANSI FC-PI-3
FC classification	ANSI FC-PI-3	ANSI FC-PI-3	ANSI FC-PI-3	ANSI FC-PI-3	ANSI FC-PI-3
Laser type	VCSEL	VCSEL	DFB	CML	EML
Eye safety	Class 1	Class 1	Class 1	Class 1	Class 1
Connector	LC	LC	LC	LC	LC

## SFP/SFP+ FTTA INTERFACES

### CPRI/OBSAI

Wavelength (nm)	850	1310	1310	1310	1550
EXFO product number	FTB-8590	FTB-8190	FTB-8191	SFP-8600	FTB-8192
Tx level (dBm)	-9 to -3	-5 to 0	-2 to 3	-8.2 to 0.5	-2 to 3
Rx level sensitivity (dBm)	-18 to 0	-18 to 0	-27 to -9	0.5 (max)	-28 to -9
Maximum reach	300 m on OM3 MMF	15 km	40 km	1.4 km (SMF)	80 km
Transmission bit rate (Gbit/s)	2.4576/3.072	2.4576/3.072	2.4576/3.072	1.2288-9.8304	2.4576/3.072
Reception bit rate (Gbit/s)	2.4576/3.072	2.4576/3.072	2.4576/3.072	1.2288-9.8304	2.4576/3.072
Tx operational wavelength range (nm)	830-860	1270-1360	1280 to 1355	1260 to 1355	1500 to 1580
Measurement accuracy (uncertainty) Optical power (dB)	±2	±2	±2	±2	±2
Max Rx before damage (dBm)	+5	+5	+3	+5	+3
Jitter compliance	IEEE 802.3	GR-253 (SONET) G-958 (SDH)	GR-253 (SONET) G-958 (SDH)	IEEE 802.3ae	GR-253 (SONET) G-958 (SDH)
Laser type	VCSEL	DFB	DFB	FP	CML
Eye safety	Class 1	Class 1	Class 1	Class 1	Class 1
Connector	LC	LC	LC	LC	LC
Transceiver type	SFP	SFP	SFP	SFP+	SFP

## SYNCHRONIZATION INTERFACES

	External Clock DS1/1.5M	External Clock E1/2M	External Clock E1/2M	Trigger 2 MHz
Tx pulse amplitude	2.4 to 3.6 V	3.0 V	2.37 V	0.75 to 1.5 V
Tx pulse mask	GR-499 Figure 9.5	G.703 Figure 15	G.703 Figure 15	G.703 Figure 20
Tx LBO preamplification	Typical power dBdsx +0.6 dBdsx (0-133 ft) +1.2 dBdsx (133-266 ft) +1.8 dBdsx (266-399 ft) +2.4 dBdsx (399-533 ft) +3.0 dBdsx (533-655 ft)			
Rx level sensitivity	TERM: ≤6 dB (cable loss only) (at 772 kHz for T1) DSX-MON: ≤26 dB (20 dB resistive loss + cable loss ≤ 6 dB) Bridge: ≤6 dB (cable loss only)	TERM: ≤6 dB (cable loss only) MON: ≤26 dB (20 dB resistive loss + cable loss ≤ 6 dB) Bridge: ≤6 dB (cable loss only)	TERM: ≤6 dB (cable loss only) MON: ≤26 dB (resistive loss + cable loss ≤ 6 dB) Bridge: ≤6 dB (cable loss only)	≤6 dB (cable loss only)
Transmission bit rate	1.544 Mbit/s ± 4.6 ppm	2.048 Mbit/s ± 4.6 ppm	2.048 Mbit/s ± 4.6 ppm	
Reception bit rate	1.544 Mbit/s ± 50 ppm	2.048 Mbit/s ± 50 ppm	2.048 Mbit/s ± 50 ppm	
Intrinsic jitter (Tx)	ANSI T1.403 section 6.3 GR-499 section 7.3	G.823 section 6.1	G.823 section 6.1	G.703 table 11
Input jitter tolerance	AT&T PUB 62411 GR-499 section 7.3	G.823 section 7.2 G.813	G.823 section 7.2 G.813	G.823 section 7.1 G.751 section 3.3
Line coding	AMI and B8ZS	AMI and HDB3	AMI and HDB3	
Input impedance (resistive termination)	75 ohms ± 5 %, unbalanced	75 ohms ± 5 %, unbalanced	75 ohms ± 5 %, unbalanced	75 ohms ± 5 %, unbalanced
Connector type	BNC <sup>a</sup>	BNC <sup>a</sup>	BNC	BNC

**Note**

a. Adaptation cable required for BANTAM.

## FIBRE CHANNEL FUNCTIONAL SPECIFICATIONS

### TESTING 1x, 2x, 4x, 8x, 10x

BERT	Framed FC-2
Patterns (BERT)	PRBS 2E31-1, 2E23-1, 2E20-1, 2E15-1, 2E11-1, 2E9-1, one user-defined pattern and capability to invert patterns
Error insertion	Bit error, amount and rate
Error measurement	Bit error, symbol error, oversize error, crc error, undersize error and block error (10x only)
Alarm detection	LOS, pattern loss, link down, local and remote fault (10x only)
Buffer-to-buffer credit testing	Buffer-to-buffer credit estimation based on latency
Latency	Round-trip latency

SONET AND DS <sub>N</sub> FUNCTIONAL SPECIFICATIONS		SDH AND PDH FUNCTIONAL SPECIFICATIONS	
Optical interfaces	OC-1, OC-3, OC-12, OC-48, OC-192	Optical interfaces	STM-0, STM-1, STM-4, STM-16, STM-64
Available wavelengths (nm)	1310, 1550	Available wavelengths (nm)	1310, 1550
Electrical interfaces	DS1, DS3, STS-1e, STS-3e	Electrical interfaces <sup>a</sup>	1.5M (DS1), 2M (E1), 34M (E3), 45M (DS3), 140M (E4), STM-0e, STM-1e
DS1 framing	Unframed, SF, ESF, SLC-96	2M (E1) framing	Unframed, PCM30, PCM31, PCM30 CRC-4, PCM31 CRC-4
DS3 framing	Unframed, M13, C-bit parity	8M (E2), 34M (E3), 140M (E4) framing	Unframed (not applicable to E2), framed
Clocking	Internal, loop-timed, external (BITS)	Clocking	Internal, loop-timed, external (MTS/SETS), 2 MHz
<b>Mappings</b>			
VT1.5	Bulk, DS1	AU-3-TU-11, AU-4-TU-11	Bulk, 1.5M,
VT2	Bulk, E1	AU-3-TU-12, AU-4-TU-12	Bulk, 1.5M, 2M
STS-1 SPE	Bulk, DS3	AU-3-Bulk, 34M, 45M, TU-3-AU-4	Bulk, 34M, 45M
STS-3c	Bulk	AU-4	Bulk, 140M
STS-12c/48c/192c, SPE	Bulk	AU-4-4c/16c/64c	Bulk
SONET overhead analysis and manipulation	A1, A2, J0, E1, F1, D1-D12, K1, K2, S1, M0, M1, E2, J1, C2, G1, F2, H4, Z3, Z4, Z5, N1, N2, Z6, Z7	SDH overhead analysis and manipulation	A1, A2, J0, E1, F1, D1-D12, K1, K2, S1, M0, M1, G1, F2, F3, K3, N1, N2, K4, E2, J1, C2, H4
<b>Error insertion</b>			
DS1	Framing bit, BPV, CRC-6, bit error, EXZ	E1 (2M)	Bit error, FAS, CV, CRC-4, E-bit
DS3	BPV, C-bit, F-bit, P-bit, FEBE, bit error, EXZ	E2 (8M), E3 (34M), E4 (140M)	Bit error, FAS, CV (not applicable to E2)
STS-1e, STS-3e	Section BIP (B1), line BIP (B2), path BIP (B3), BIP-2, REI-L, REI-P, REI-V, BPV, FAS, CV, bit error	STM-0e, STM-1e	RS-BIP (B1), MS-BIP (B2), HP-BIP (B3), MS-REI, HP-REI, LP-BIP-2, LP-REI, CV, FAS, bit error
OC-1, OC-3, OC-12, OC-48, OC-192	Section BIP (B1), line BIP (B2), path BIP (B3), BIP-2, REI-L, REI-P, REI-V, FAS, bit error	STM-0, STM-1, STM-4, STM-16, STM-64	RS-BIP (B1), MS-BIP (B2), HP-BIP (B3), MS-REI, HP-REI, LP-BIP-2, LP-REI, FAS, bit error
<b>Error measurement</b>			
DS1	Framing bit, BPV, CRC-6, EXZ, bit error	E1 (2M)	Bit error, FAS, CV, CRC-4, E-bit
DS3	BPV, C-bit, F-bit, P-bit, FEBE, bit error, EXZ	E2 (8M), E3 (34M), E4 (140M)	Bit error, FAS, CV (not applicable to E2)
STS-1e, STS-3e	Section BIP (B1), line BIP (B2), path BIP (B3), BIP-2, REI-L, REI-P, REI-V, BPV, FAS, CV, bit error	STM-0e, STM-1e	RS-BIP (B1), MS-BIP (B2), HP-BIP (B3), MS-REI, HP-REI, LP-BIP-2, LP-REI, CV, FAS, bit error
OC-1, OC-3, OC-12, OC-48, OC-192	Section BIP (B1), line BIP (B2), path BIP (B3), BIP-2, REI-L, REI-P, REI-V, FAS, bit error	STM-0, STM-1, STM-4, STM-16, STM-64	RS-BIP (B1), MS-BIP (B2), HP-BIP (B3), MS-REI, HP-REI, LP-BIP-2, LP-REI, FAS, bit error
<b>Alarm insertion</b>			
DS1	LOS, RAI, AIS, OOF, pattern loss	E1 (2M)	LOS, LOS Mframe, LOF, AIS, TS16 AIS, RAI, RAI Mframe, pattern loss
DS3	LOS, RDI, AIS, OOF, DS3 idle, pattern loss	E2 (8M), E3 (34M), E4 (140M)	LOS, LOF, RAI, AIS, pattern loss
STS-1e, STS-3e, OC-1, OC-3, OC-12, OC-48, OC-192	LOS, LOF-S, SEF, AIS-L, RDI-L, AIS-P, LOP-P, LOM, PDI-P, RDI-P, ERDI-PCD, ERDI-PPD, ERDI-PSD, UNEQ-P, AIS-V, LOP-V, RDI-V, ERDI-VCD, ERDI-VPD, ERDI-VSD, RFI-V, UNEQ-V, pattern loss	STM-0e, STM-1e, STM-0, STM-1, STM-4, STM-16, STM-64	LOS, LOF, OOF, MS-AIS, MS-RDI, AU-AIS, AU-LOP, H4-LOM, HP-ERDI-CD, HP-ERDI-PD, HP-ERDI-SD, LP-ERDI-CD, LP-ERDI-PD, LP-ERDI-SD, HP-UNEQ, TU-AIS, LP-RFI, LP-RDI, LP-RFI, LP-UNEQ, pattern loss
<b>Alarm detection</b>			
DS1	LOS, LOC, RAI, AIS, OOF, pattern loss	E1 (2M)	LOS, LOS Mframe, LOC, LOF, AIS, TS16 AIS, RAI, RAI Mframe, pattern loss
DS3	LOS, LOC, RDI, AIS, OOF, DS3 idle, pattern loss	E2 (8M), E3 (34M), E4 (140M)	LOS, LOC, LOF, RAI, AIS, pattern loss
STS-1e, STS-3e, OC-1, OC-3, OC-12, OC-48, OC-192	LOS, LOC, LOF-S, SEF, TIM-S, AIS-L, RDI-L, AIS-P, LOP-P, LOM, PDI-P, RDI-P, ERDI-PCD, ERDI-PPD, ERDI-PSD, PLM-P, UNEQ-P, TIM-P, AIS-V, LOP-V, RDI-V, ERDI-VCD, ERDI-VPD, ERDI-VSD, RFI-V, UNEQ-V, TIM-V, PLM-V, pattern loss	STM-0e, STM-1e, STM-0, STM-1, STM-4, STM-16, STM-64	LOS, RS-LOF, LOC, RS-OOF, RS-TIM, MS-AIS, MS-RDI, AU-AIS, AU-LOP, H4-LOM, HP-RDI, HP-ERDI-CD, HP-ERDI-PD, HP-ERDI-SD, LP-ERDI-CD, LP-ERDI-PD, LP-ERDI-SD, HP-PLM, HP-UNEQ, HP-TIM, TU-AIS, LP-RFI, LP-RDI, LP-RFI, LP-UNEQ, LP-TIM, LP-PLM, pattern loss
<i>Frequency alarm on all supported interfaces</i>			
<b>Patterns</b>			
DS0	2E9-1, 2E11-1, 2E20-1, 1100, 1010, 1111, 0000, 1-in-8, 1-in-16, 3-in-24, 32 bit programmable (inverted or non-inverted), bit errors	E0 (64K)	2E9-1, 2E11-1, 2E20-1, 1100, 1010, 1111, 0000 1-in-8, 1-in-16, 3-in-24, 32 bit programmable (inverted or non-inverted), bit errors
DS1	2E9-1, 2E11-1, 2E15-1, 2E20-1, 2E23-1, 2E31-1, 1100, 1010, 1111, 0000, QRSS, 1-in-8, 1-in-16, 3-in-24, 32 bit programmable (inverted or non-inverted), T1-DALY, 55-octet, bit errors, multipattern	E1 (2M)	2E9-1, 2E11-1, 2E15-1, 2E20-1, 2E23-1, 2E31-1, 1100, 1010, 1111, 0000, 1-in-8, 1-in-16, 3-in-24, 32 bit programmable (inverted or non-inverted), bit errors
DS3	2E9-1, 2E11-1, 2E15-1, 2E20-1, 2E23-1, 2E31-1, 1100, 1010, 1111, 0000, 1-in-8, 1-in-16, 3-in-24, 32 bit programmable (inverted or non-inverted), bit errors	E3 (34M), E4 (140M)	2E9-1, 2E11-1, 2E15-1, 2E20-1, 2E23-1, 2E31-1, 1100, 1010, 1111, 0000, 1-in-8, 1-in-16, 3-in-24 <sup>b</sup> , 32 bit programmable (inverted or non-inverted), bit errors
VT1.5/2	2E9-1, 2E11-1, 2E15-1, 2E20-1, 2E23-1, 2E31-1, 1100, 1010, 1111, 0000, 1-in-8, 1-in-16, 32 bit programmable (inverted or non-inverted), bit errors	TU-11/12/3	2E9-1, 2E11-1, 2E15-1, 2E20-1, 2E23-1, 2E31-1, 1100, 1010, 1111, 0000, 1-in-8, 1-in-16, 32 bit programmable (inverted or non-inverted), bit errors
STS-1, STS-3c/12c/48c/192c	2E9-1, 2E11-1, 2E15-1, 2E20-1, 2E23-1, 2E31-1, 1100, 1010, 1111, 0000, 1-in-8, 1-in-16, 32 bit programmable (inverted or non-inverted), bit errors	AU-3/AU-4/AU-4-4c/16c/64c	2E9-1, 2E11-1, 2E15-1, 2E20-1, 2E23-1, 2E31-1, 1100, 1010, 1111, 0000, 1-in-8, 1-in-16, 32 bit programmable (inverted or non-inverted), bit errors
<i>Pattern loss and bit error generation and analysis supported on all patterns</i>			

**Notes**

- a. 1.5M (DS1) and 45M (DS3) interfaces described under SONET and DS<sub>n</sub> column.
- b. Not supported for E4 (140M).

## DSn/PDH AND SONET/SDH TEST FEATURES

Frequency measurements	Supports clock frequency measurements (i.e., received frequency and deviation of the input signal clock from nominal frequency), displayed in ppm, for optical and electrical interfaces. Measurements are performed using a local oscillator.														
Frequency offset generation	Supports offsetting the clock of the transmitted signal on a selected interface to exercise clock recovery circuitry on network elements.														
Dual DSn receivers	Supports two DS1 or DS3 receivers, allowing users to simultaneously monitor two directions of a circuit under test in parallel, resulting in quick isolation of the source of errors.														
Performance monitoring	The following ITU-T recommendations, and corresponding performance monitoring parameters, are supported: <table border="0"> <tr> <td><b>ITU-T recommendation</b></td> <td><b>Performance monitoring statistics</b></td> </tr> <tr> <td>G.821</td> <td>ES, EFS, EC, SES, UAS, ESR, SESR, DM</td> </tr> <tr> <td>G.826</td> <td>ES, EFS, EB, SES, BBE, UAS, ESR, SESR, BBER</td> </tr> <tr> <td>G.828</td> <td>ES, EFS, EB, SES, BBE, SEP, UAS, ESR, SESR, BBER, SEPI</td> </tr> <tr> <td>G.829</td> <td>ES, EFS, EB, SES, BBE, UAS, ESR, SESR, BBER</td> </tr> <tr> <td>M.2100</td> <td>ES, SES, UAS</td> </tr> <tr> <td>M.2101</td> <td>ES, SES, BBE, UAS</td> </tr> </table>	<b>ITU-T recommendation</b>	<b>Performance monitoring statistics</b>	G.821	ES, EFS, EC, SES, UAS, ESR, SESR, DM	G.826	ES, EFS, EB, SES, BBE, UAS, ESR, SESR, BBER	G.828	ES, EFS, EB, SES, BBE, SEP, UAS, ESR, SESR, BBER, SEPI	G.829	ES, EFS, EB, SES, BBE, UAS, ESR, SESR, BBER	M.2100	ES, SES, UAS	M.2101	ES, SES, BBE, UAS
<b>ITU-T recommendation</b>	<b>Performance monitoring statistics</b>														
G.821	ES, EFS, EC, SES, UAS, ESR, SESR, DM														
G.826	ES, EFS, EB, SES, BBE, UAS, ESR, SESR, BBER														
G.828	ES, EFS, EB, SES, BBE, SEP, UAS, ESR, SESR, BBER, SEPI														
G.829	ES, EFS, EB, SES, BBE, UAS, ESR, SESR, BBER														
M.2100	ES, SES, UAS														
M.2101	ES, SES, BBE, UAS														
Pointer adjustment and analysis	Generation and analysis of HO/AU and LO/TU pointer adjustments as per GR-253, and ITU-T G.707 <table border="0"> <tr> <td><b>Generation</b></td> <td><b>Analysis</b></td> </tr> <tr> <td> <ul style="list-style-type: none"> <li>· Pointer increment and decrement</li> <li>· Pointer jump with or without NDF</li> <li>· Pointer value</li> </ul> </td> <td> <ul style="list-style-type: none"> <li>· Pointer increments</li> <li>· Pointer decrements</li> <li>· Pointer jumps (NDF, no NDF)</li> <li>· Pointer value and cumulative offset</li> </ul> </td> </tr> </table>	<b>Generation</b>	<b>Analysis</b>	<ul style="list-style-type: none"> <li>· Pointer increment and decrement</li> <li>· Pointer jump with or without NDF</li> <li>· Pointer value</li> </ul>	<ul style="list-style-type: none"> <li>· Pointer increments</li> <li>· Pointer decrements</li> <li>· Pointer jumps (NDF, no NDF)</li> <li>· Pointer value and cumulative offset</li> </ul>										
<b>Generation</b>	<b>Analysis</b>														
<ul style="list-style-type: none"> <li>· Pointer increment and decrement</li> <li>· Pointer jump with or without NDF</li> <li>· Pointer value</li> </ul>	<ul style="list-style-type: none"> <li>· Pointer increments</li> <li>· Pointer decrements</li> <li>· Pointer jumps (NDF, no NDF)</li> <li>· Pointer value and cumulative offset</li> </ul>														
Service disruption time (SDT) measurements	The service disruption time test tool measures the time during which there is a disruption of service due to the network switching from the active channels to the backup channels. Measurements: last disruption, shortest disruption, longest disruption, average disruption, total disruption, and service disruption count.														
Round-trip delay (RTD) measurements	The round-trip delay test tool measures the time required for a bit to travel from the NetBlazer transmitter back to its receiver after crossing a far-end loopback. Measurements are provided on all supported NetBlazer interfaces and mappings. Measurements: last, minimum, maximum, average; measurement count: no. of successful RTD tests and failed measurement count.														
APS message control and monitoring	Ability to monitor and set up automatic protection switching messages (K1/K2 byte of SONET/SDH overhead).														
Synchronization status	Ability to monitor and set up synchronization status messages (S1 byte of SONET/SDH overhead).														
Signal label control and monitoring	Ability to monitor and set up payload signal labels (C2, V5 byte of SONET overhead).														
Tandem connection monitoring (TCM) <sup>a</sup>	Tandem connection monitoring (TCM) is used to monitor the performance of a subsection of a SONET/SDH path routed via different network providers. The NetBlazer supports transmitting and receiving alarms and errors on a TCM link; also, transmission and monitoring of the tandem connection (TC) trace can be generated to verify the connection between TCM equipment. Error generation: TC-IEC, TC-BIP, TC-REI, TC-OEI Error analysis: TC-IEC, TC-REI, TC-OEI, TC-VIOL (non-standardized alarm) Alarm generation: TC-RDI, TC-UNEQ, TC-ODI, TC-LTC, TC-IAIS Alarm analysis: TC-TIM, TC-RDI, TC-UNEQ, TC-ODI, TC-LTC, TC-IAIS														
Pointer sequence testing	Perform pointer sequence testing as per G.783, GR253 and T1.105-3 standards.														
M13 mux/demux	Ability to multiplex/demultiplex a DS1 signal into/from a DS3 signal. (Note: E1 to DS3 mux/demux available with G.747 software option.)														
DS1 FDL	Support for DS1 Facility Data Link testing.														
DS1 loopcodes	Support for generation of DS1 in-band loopcodes with the availability of up to 10 pairs of user-defined loopcodes.														
NI/CSU loopback emulation	Ability to respond to DS1 in-band/out-of-band loopcodes.														
DS3 FEAC	Support for DS3 far-end alarms and loopback code words.														
DS1/DS3 autodetection	Ability to automatically detect DS1/DS3 line coding, framing and test pattern.														
DS1 multipattern	BER test that includes 5 automated patterns: all ones, 1 in 8, 2 in 8, 3 in 2, QRSS														
DS1 signaling bits	Ability to monitor the ABCD signaling bits for all 24 DS0 channels														
Through mode	Perform Through mode analysis of any incoming electrical (DSn, PDH, SONET, SDH) and optical line (OC-1/STM-0, OC-3/STM-1, OC-12/STM-4, OC-48/STM-16, OC-192/STM-64) transparently.														

### Note

a. HOP and LOP supported as per ITU G.707 option 2.



OTN TEST FEATURES		
<b>OTN</b>	Standards compliance	ITU-T G.709, ITU G.798, ITU G.872
	Interfaces	OTU1 (2.6660 Gbit/s), OTU2 (10.7092 Gbit/s), OTU1e (11.0491 Gbit/s), OTU2e (11.0957 Gbit/s), OTU1f (11.2701 Gbit/s), OTU2f (11.3176 Gbit/s)
<b>OTU Layer</b>	Errors	OTU-FAS, OTU-MFAS, OTU-BEI, OTU-BIP-8
	Alarms	LOF, OOF, LOM, OOM, OTU-AIS, OTU-TIM, OTU-BDI, OTU-IAE, OTU-BIAE
	Traces	64-bytes Trail Trace Identifier (TTI) as defined in ITU-T G.709
<b>ODU TCM Layer</b>	Errors	TCMi-BIP-8, TCMi-BEI (i = 1 to 6)
	Alarms	TCMi-LTC, TCMi-TIM, TCMi-BDI, TCMi-IAE, TCMi-BIAE
	Traces	64-bytes Trail Trace Identifier (TTI) as defined in ITU-T G.709
<b>ODU Layer</b>	Errors	ODU-BIP-8, ODU-BEI
	Alarms	ODU-AIS, ODU-OCI, ODU-LCK, ODU-TIM, ODU-BDI, ODU-FSF, ODU-BSF, ODU-FSD, ODU-BSL
	Traces	Generates 64-bytes Trail Trace Identifier (TTI) as defined in ITU-T G.709
	FTFL <sup>b</sup>	As defined in ITU-T G.709
<b>OPU Layer</b>	Alarms	OPU-PLM, OPU-AIS, OPU-CSF
	Payload type (PT) label	Generates and displays received PT value
<b>Forward Error Correction (FEC)</b>	Errors	FEC-Correctable (Codeword), FEC-Uncorrectable (Codeword), FEC-Correctable (Symbol), FEC-Correctable (Bit), and FEC-Stress (Codeword)
<b>Pattern</b>	Patterns	2E-9, 2E-15, 2E-20, 2E-23, 2E-31, NULL, 32-bit programmable (inverted or noninverted)
	Error	Bit error
	Alarm	Pattern loss

ADDITIONAL OTN FUNCTION							
Frequency measurements	Supports clock frequency measurements (i.e., received frequency and deviation of the input signal clock from nominal frequency), displayed in ppm. Measurements are performed using a local oscillator.						
Frequency offset generation	Supports offsetting the clock of the transmitted signal on a selected interface to exercise clock recovery circuitry on network elements.						
Performance monitoring	The following ITU-T recommendations and corresponding performance monitoring parameters are supported: <table border="0" style="width: 100%;"> <tr> <td style="width: 50%;"><b>ITU-T recommendation</b></td> <td style="width: 50%;"><b>Performance monitoring statistics</b></td> </tr> <tr> <td>G.821</td> <td>ES, EFS, EC, SES, UAS, ESR, SESR, DM</td> </tr> <tr> <td>M.2100</td> <td>ES, SES, UAS</td> </tr> </table>	<b>ITU-T recommendation</b>	<b>Performance monitoring statistics</b>	G.821	ES, EFS, EC, SES, UAS, ESR, SESR, DM	M.2100	ES, SES, UAS
<b>ITU-T recommendation</b>	<b>Performance monitoring statistics</b>						
G.821	ES, EFS, EC, SES, UAS, ESR, SESR, DM						
M.2100	ES, SES, UAS						
Service disruption time (SDT) measurements	The service disruption time test tool measures the time during which there is a disruption of service due to the network switching from the active channels to the backup channels. Measurements: last disruption, shortest disruption, longest disruption, average disruption, total disruption, and service disruption count.						
Round-trip delay (RTD) measurements	The round-trip delay test tool measures the time required for a bit to travel from the transmitter back to its receiver after crossing a far-end loopback. Measurements are supported on all interfaces and mappings. Measurements: last RTD time, minimum, maximum, average, measurement count (no. of successful RTD tests) and failed measurement count.						
Through mode	Perform Through mode analysis of any incoming OTN signal transparently.						

## ISDN PRIMARY RATE INTERFACE TEST FEATURES

Supported interfaces	DS1: bantam or RJ48C (SF or ESF) E1: bantam, RJ48C or BNC (PCM31 with or without CRC-4)
Supported switch types	DS1: national ISDN, Nortel DMS and AT&T 4/5ESS E1: euro ISDN, euro VN6 and Q.SIG
Emulation modes	Terminal equipment (TE) Network termination (NT)
Call types/rates	Data (64K or 56K), voice or 3.1 kHz (audio)
BER test	Configurable test pattern Provides simultaneous BER testing on multiple B-channels configured with data traffic
Call setting	Calling party (numbering type, numbering plan and number up to 30 digits) Called party (number type, numbering plan and number up to 30 digits) Network (network transit selection code of up to four digits, and operator system access: None, Principal or Alternate) > All parameters are configurable on a per-call basis > Highlights missing calls or called party numbers
Call control	Call origination > Establishment of calls prior to starting the test > Automatically initiate single, multiple or all configured calls upon starting a test Call reception > Auto-Answer mode, Auto-Reject or prompt Call release > Hang up individual or all channels
DTMF injection	Generate DTMF tones for all standard digits, including 0-9, # and * as per Q.23/G.224 Available for one of the connected voice or 3.1 kHz B-channel
Headset support	Talk/listen through a selectable connected voice or 3.1 kHz B-channel
D-channel control	D-channel timeslot configuration Rate (64K or 56K) HDLC mode (Normal or Inverted)
Statistics	Call status, CRV, incoming or outgoing calls, call duration BERT (bit error count and rate) with graphical BERT meter on a per B-channel (data) basis Performance monitoring statistics: UAS, EFS, ES and SES Active calls (data, voice, 3.1 kHz) Total call count (connected, cleared, failed/rejected, placed) Frequency (Rx, offset, max +/-max - offset)
Alarms	DS1: LOS, frequency, LOC, AIS, OOF, RAI, D-channel down E1: LOS, frequency, LOC, AIS, LOF, RAI, D-channel down Pattern loss (per B-channel injection)
Errors	DS1: BPV, EXZ, framing bit, CRC-6, D-channel FCS E1: CV, FAS, CRC-4, E-bit, D-channel FCS Bit error (per B-channel injection)
ISDN logger	Logs layer-2 (Q.921) and layer-3 (Q.931) messages Filter: All, layer 2 or layer 3 Information: ID, time, message type, direction, channel number, called number, call type, cause values/definition, status and progress
Pass/fail verdict	BERT, call establishment and termination
Phone book	Easy access to phone book to manage names and associated numbers. Save/load functions to update the phone book and import/export to exchange the phone book with other NetBlazer

## ETHERNET TEST FEATURES

EtherSAM (ITU-T Y.1564)	Perform service configuration and service performance tests as per ITU-T Y.1564 including EBS, CBS and EMIX. Tests can be performed using remote loopback or dual test mode for bidirectional results.
RFC 2544	Throughput, back-to-back, frame loss and latency measurements according to RFC 2544. Frame size: RFC-defined sizes, user-configurable between 1-7 sizes.
Traffic generation and monitoring	Traffic generation and shaping of up to 16 streams of Ethernet and IP traffic including the simultaneous monitoring of throughput, frame loss, packet jitter, latency and out-of-sequence frames. Also includes the ability to generate fixed, random and frame size sweep, as well as MAC flooding.
Carrier Ethernet OAM	Supports four S-OAM modes, MEF, Y.1731, G.8113.1 (MPLS-TP) and 802.1ag. CCM generation and monitoring, loopback, test, frame loss, synthetic loss and frame delay. Alarm generation: AIS, RDI, LCK, CSF(C-LOS, C-RDI, C-FDI, C-DCI). Alarm monitoring: RDI, AIS, LCK, CSF, loss of continuity, mismerge, unexpected MEP, unexpected MEG/MD level, unexpected period supports S-OAM responder, S-OAM link trace, ping and trace route, filters and packet capture.
Packet capture and filters	Ability to perform 10BASE-T all the way up to 10 GigE full line-rate packet capture and decode. Ability to configure filter full line-rate data capture and decoding up to 10G; configuration of capture filters and triggers as well as capture slicing parameters.
Through mode	Sectionalize traffic between a service provider's network and customer premises equipment.
BER testing	Up to layer 4 supported with or without VLAN Q-in-Q.
Patterns (BERT)	PRBS 2E9-1, PRBS 2E11-1, PRBS 2E15-1, PRBS 2E20-1, PRBS 2E23-1, PRBS 2E31-1 and one user pattern. Capability to invert patterns.
Error measurement (BERT)	Bit error, bit mismatch 0, bit mismatch 1.
VLAN stacking	Generate up to three levels of VLANs (including IEEE 802.1ad and Q-in-Q tagged VLAN).
MPLS	Generate and analyze streams with up to two layers of MPLS labels.
Cable testing	Category 5 cable (or better), 100 UTP/STP cable, ≤120 meters.
Service disruption time (SDT)	Includes statistics such as longest, shortest, last, average, count, total and pass/fail thresholds.
IPv6 testing	Perform the following tests up to 10G over IPv6, EtherSAM, RFC 2544, BERT, traffic generation and monitoring, Through mode, intelligent auto discovery, ping and trace route.
10 GigE WAN testing	Includes WAN interface sublayer, J0/J1 trace and C2 label generation, J0/J1 trace and C2 label monitoring.
10 GigE WAN alarm monitoring	Includes SEF, LOF, AIS-L, RDI-L, AIS-P, RDI-P, LCD-P, LOP-P, PLM-P, UNEQ-P, ERDI-P, WIS link down, B1, B2, B3, REI-L, REI-P.
TCP throughput	True wire speed, TCP throughput test for undisputable SLA reinforcement for Ethernet services.
One-way delay	Measurement of the one-way frame delay at up to 10G as part of EtherSAM (Y.1564) and RFC 2544.
Error measurement	Jabber/giant, runt, undersize, oversize, FCS, symbol, alignment, collision, late collision, excessive collision, IP checksum, UDP checksum, TCP checksum and 10G block error.
Alarm detection	LOS, link down, pattern loss, frequency, LOC, 10G local/remote fault.
Flow control	Inject or monitor pause frames, including frame counts of pause, abort frames and total, last, maximum and minimum pause time.
Batch configuration	Ability to automatically set a specific source IP address, subnet mask, default gateway, DHCP, destination MAC address or destination IP address to one or all EtherSAM services or traffic generation streams.

ADDITIONAL FEATURES	
FTTA BER testing	Includes BER measurement, bit error injection, round-trip delay measurement and pass/fail verdict for 1.2 to 9.8 Gbit/s rates.
1588 PTP	Validates 1588 PTP packet network synchronization services, emulates PTP clients, generates and analyzes messages between master/clients, clock quality level and IPDV.
SyncE	Validates SyncE frequency, ESMC messages and clock quality levels.
Power measurement	Supports power measurement at all times, displayed in dBm (dBdsx for DS1 and DS3), for optical and electrical interfaces.
Power-up and restore	In the event of a power failure to the unit, the active test configuration and test logger are saved and restored upon boot-up.
Save and load configuration	Store and load test configurations to/from a non-volatile USB memory stick or internal flash.
Pass/fail analysis	Provides a pass/fail outcome with user-adjustable thresholds, based on bit error rate and/or service disruption time.
Alarm hierarchy	Alarms are displayed according to a hierarchy based on root cause. Secondary effects are not displayed. This hierarchy serves to facilitate alarm analysis.
Report generation	Generate test reports with customizable selections, company logos and clear pass/fail color-coded analysis, in both HTML and PDF formats, and save them directly on the unit, on a USB stick or via EXFO Connect.
Event logger	Log test results with absolute or relative time and date, details and duration of events, color-coded events and pass/fail outcome.
Remote control	Remote control via VNC or Remote Desktop.
Remote loopback	Detects other NetBlazer/PowerBlazer units and sets them to Smart Loopback mode.
Dual test set	Detects and connects to other NetBlazer/PowerBlazer units to perform bidirectional RFC 2544 and EtherSAM testing.
Dual-port mode	Enables any Ethernet test, such as EtherSAM, RFC 2544, Traffic Generation and monitoring, or BERT to run directly to itself using one self-contained unit with loopback.
IP tools	Perform ping and traceroute functions.
Smart loopback	Return Ethernet traffic to the local unit by swapping packet overhead up to layer 4.
Test timer	Select a pre-defined duration or enter start and stop times.

UPGRADES	
<b>SFP upgrades</b>	FTB-8590 SFP module GigE/FC/2FC, CPRI/OBSAI 2.45/3.07 Gbit/s at 850 nm, MM, <500 m
	FTB-85910 SFP modules 100 Base-FX, 1340 nm, MM, 2 km
	FTB-85911 SFP modules 100 Base-LX10, 1310 nm, SM, 15 km
	FTB-85912 SFP modules GigE/FC/2FC/4FC at 850 nm, <500 m
	FTB-8190 SFP module; rates: 155/622 Mbit/s, 2.5/2.7 Gbit/s, GigE/FC/2FC, CPRI/OBSAI 2.45/3.07 Gbit/s at 1310 nm, LC connector, 15 km reach
	FTB-8191 SFP module; rates: 155/622 Mbit/s, 2.5/2.7 Gbit/s, GigE/FC/2FC; CPRI/OBSAI 2.45/3.07 Gbit/s at 1310 nm, LC connector, 40 km reach
	FTB-8192 SFP module; rates: 155/622 Mbit/s, 2.5/2.7 Gbit/s, GigE/FC/2FC; 1550 nm, LC connector, 80 km reach
	FTB-8193 SFP module; rates: 155/622 Mbit/s, 2.5/2.7 Gbit/s, GigE/FC/2FC; 1550 nm, LC connector, 40 km reach
	FTB-85913 SFP modules GigE/FC/2FC/4FC at 1310 nm, 4 km
	FTB-85914 SFP modules GigE/FC/2FC/4FC at 1310 nm, 30 km
	FTB-85915 SFP modules GigE/FC/2FC/4FC at 1550 nm, <50 km
<b>SFP+ upgrades</b>	SFP-8600 SFP+ modules CPRI 1.228–9.83 Gbit/s at 1310 nm, LC connector, 1.4 km
	FTB-8690 SFP+ modules 10FC/10 GigE at 850 nm, MM, 300 m
	FTB-8691 SFP+ modules 10 GigE at 1310 nm, 10 km
	FTB-8693 SFP+ modules 9.953-10.709/11.3, 8FC/10FC/10 GigE at 1310 nm, SMF, 10 km
	FTB-8694 SFP+ modules 8FC/10FC/10 GigE at 1550 nm, 40 km
	FTB-8695 SFP+ modules 8FC/10FC/10 GigE at 1550 nm, 80 km
<b>Bidirectional SFP upgrades</b>	FTB-8596 SFP modules bidirectional 1490 Tx 1310 Rx 1000 BASE-BX10
	FTB-8597 SFP modules bidirectional 1310 Tx 1490 Rx 1000 BASE-BX10
	FTB-8598 SFP modules bidirectional 1310 Tx 1490/1550 Rx 1000 BASE-BX
	FTB-8599 SFP modules bidirectional 1550 Tx 1310 Rx 1000 BASE-BX

GENERAL SPECIFICATIONS	
Size (H x W x D)	130 mm x 252 mm x 56 mm (5 1/8 in x 9 15/16 in x 2 3/16 in)
Weight (without battery)	0.97 kg (2.1 lb)
Temperature	
Operating	0 °C to 50 °C (32 °F to 122 °F)
Storage	-40 °C to 70 °C (-40 °F to 158 °F)
Relative humidity	0 % to 93 %, non-condensing
Battery life (extended)	Up to four hours
Battery life (standard)	Up to two hours
Battery charging time (extended)	Two-and-a-half hours
Battery charging time (standard)	Three-and-a-half hours
Languages	English, Chinese, Japanese and Korean

## CHOOSE THE RIGHT NETBLAZER MODULE FOR YOUR TESTING APPLICATIONS

MODULES	TRANSPORT ONLY		LOOPBACK ONLY	ETHERNET ONLY		MULTISERVICE	
	FTB-810	FTB-810G	FTB-860GL	FTB-860	FTB-860G	FTB-870	FTB-880
DSn/PDH testing	•	•					•
ISDN (PRI)	•	•					•
SONET/SDH testing (2.5G)	•	•				•	•
SONET/SDH testing (10G)		•				•	•
OTN						•	•
Fibre Channel (1x, 2x, 4X)				•	•	•	•
Fibre Channel (8x, 10X)					•	•	•
Ethernet testing (1G)			• <sup>1</sup>	•	•	•	•
Ethernet testing (10G)			• <sup>1</sup>		•	•	•
OBSAI 3.1G				•	•	•	•
1588 PTP / SyncE				•	•	•	•
Carrier Ethernet OAM				•	•	•	•
ExacTCP				•	•	•	•
Packet Capture/Filters				•	•	•	•
CPRI 1.2G to 6.1G				•	•	•	•
CPRI 1.2G to 9.8G					•	•	•

<sup>1</sup> Simultaneous bidirectional loopback partner

**ORDERING INFORMATION (TRANSPORT ONLY)**

**FTB-810-XX-XX-XX**

**Test options**

SONET = SONET testing  
 SDH = SDH testing  
 SONET-SDH = SONET and SDH testing

**Rate options**

52M = 52 Mbit/s (OC-1/STM-0)<sup>a</sup>  
 155M = 155 Mbit/s (OC-3/STM-1)<sup>a</sup>  
 622M = 622 Mbit/s (OC-12/STM-4)  
 2488M = 2.5 Gbit/s (OC-48/STM-16)

**Software options**

DS3-G747 = G.747 test capability  
 DS1-FDL = DS1 FDL test capability  
 DUAL-RX = DS1/DS3 dual Rx testing  
 DS3-FEAC = DS3 FEAC test capability  
 TCM = Tandem connection monitoring  
 DS<sub>n</sub> = DS<sub>n</sub> test capability<sup>a</sup>  
 PDH = PDH test capability<sup>b</sup>  
 ISDN-PRI = ISDN primary rate interface  
 NI-CSU = NI-CSU loopback emulation

Example: FTB-810-SONET-622M-DUAL-RX

**FTB-810G-XX-XX-XX**

**Test options**

SONET = SONET testing  
 SDH = SDH testing  
 SONET-SDH = SONET and SDH testing

**Rate options**

52M = 52 Mbit/s (OC-1/STM-0)  
 155M = 155 Mbit/s (OC-3/STM-1)  
 622M = 622 Mbit/s (OC-12/STM-4)  
 2488M = 2.5 Gbit/s (OC-48/STM-16)  
 9953M = 10 Gbit/s (OC-192/STM-64)

**Software options**

DS3-G747 = G.747 test capability  
 DS1-FDL = DS1 FDL test capability  
 DUAL-RX = DS1/DS3 dual Rx testing  
 DS3-FEAC = DS3 FEAC test capability  
 TCM = Tandem connection monitoring  
 DS<sub>n</sub> = DS<sub>n</sub> test capability<sup>a</sup>  
 PDH = PDH test capability<sup>b</sup>  
 ISDN-PRI = ISDN primary rate interface  
 NI-CSU = NI-CSU loopback emulation

Example: FTB-810G-SONET-DUAL-RX

**Notes**

- a. Always included.
- b. Included with SDH or SONET/SDH.



**ORDERING INFORMATION (MULTISERVICE)**

**FTB-880-FLEX-XX-XX-XX-XX-XX-XX-XX**

**Test options ■**

SONET = SONET testing  
 SDH = SDH testing  
 SONET-SDH = SONET and SDH testing

**Transport rate options ■**

52M = 52 Mbit/s (OC-1/STM-0)<sup>a</sup>  
 155M = 155 Mbit/s (OC-3/STM-1)  
 622M = 622 Mbit/s (OC-12/STM-4)  
 2488M = 2.5 Gbit/s (OC-48/STM-16)  
 9953M = 10 Gbit/s (OC-192/STM-64)

**Software options ■**

DS3-G747 = G.747 test capability  
 DS1-FDL = DS1 FDL test capability  
 DUAL-RX = DS1/DS3 dual Rx testing  
 DS3-FEAC = DS3 FEAC test capability  
 TCM = Tandem connection monitoring  
 DS<sub>n</sub> = DS<sub>n</sub> test capability  
 PDH = PDH test capability  
 ISDN-PRI = ISDN primary rate interface  
 NI-CSU = NI-CSU loopback emulation  
 Cable\_test = Cable test  
 IPV6 = Internet protocol version 6  
 ETH-THRU = Through mode capability  
 CPRI-OBSAI = Enables 1.2G to 3.1G CPRI,  
 and 3.1G OBSAI<sup>b</sup>  
 MPLS = Enables MPLS  
 1588PTP = Generates and analyzes 1588 PTP  
 SyncE = Generates and analyzes SyncE protocol  
 TCP-THPUT = TCP throughput  
 ETH-OAM = Enables Y.1731, G.8113.1 (MPLS-TP), 802.1ag and MEF  
 ADV-FILTERS = Advanced filtering  
 ETH-CAPTURE = Full line-rate packet capture

**CPRI rate options**

CPRI 4.9G<sup>c</sup>  
 CPRI 6.1G<sup>c</sup>  
 CPRI 9.8G<sup>c</sup>

**OTN rate options**

OTU1 = OTN optical rate 2.666 Gbit/s  
 OTU2 = OTN optical rate 10.709 Gbit/s  
 OTU2-1e-2e = OTN optical rates 11.049/11.096 Gbit/s  
 OTU2-1f-2f = OTN optical rates 11.270/11.318 Gbit/s

**Fibre Channel rate options**

FC1X = 1x Fibre Channel interface<sup>b</sup>  
 FC2X = 2x Fibre Channel interface<sup>b</sup>  
 FC4X = 4x Fibre Channel interface<sup>b</sup>  
 FC8X = 8x Fibre Channel interface<sup>c</sup>  
 FC10X = 10x Fibre Channel interface<sup>c</sup>

**Ethernet rate options**

100optical = 100 Mbit/s optical  
 GigE = 1000 Mbit/s optical and electrical  
 10GigE = 10G LAN and 10G WAN

Example: FTB-880-FLEX-SONET-155M-DSn-GigE

**FTB-870-FLEX-XX-XX-XX-XX-XX-XX-XX**

**Test options ■**

SONET = SONET testing  
 SDH = SDH testing  
 SONET-SDH = SONET and SDH testing

**Transport rate options ■**

52M = 52 Mbit/s (OC-1/STM-0)<sup>a</sup>  
 155M = 155 Mbit/s (OC-3/STM-1)  
 622M = 622 Mbit/s (OC-12/STM-4)  
 2488M = 2.5 Gbit/s (OC-48/STM-16)  
 9953M = 10 Gbit/s (OC-192/STM-64)

**Software options ■**

Cable\_test = Cable test  
 IPV6 = Internet protocol version 6  
 ETH-THRU = Through mode capability  
 CPRI-OBSAI = Enables 1.2G to 3.1G CPRI,  
 and 3.1G OBSAI<sup>b</sup>  
 MPLS = Enables MPLS  
 1588PTP = Generates and analyzes 1588 PTP  
 SyncE = Generates and analyzes SyncE protocol  
 TCP-THPUT = TCP throughput  
 ETH-OAM = Enables Y.1731, G.8113.1 (MPLS-TP), 802.1ag and MEF  
 ADV-FILTERS = Advanced filtering  
 ETH-CAPTURE = Full line-rate packet capture

**CPRI rate options**

CPRI 4.9G<sup>c</sup>  
 CPRI 6.1G<sup>c</sup>  
 CPRI 9.8G<sup>c</sup>

**OTN rate options**

OTU1 = OTN optical rate 2.666 Gbit/s  
 OTU2 = OTN optical rate 10.709 Gbit/s  
 OTU2-1e-2e = OTN optical rates 11.049/11.096 Gbit/s  
 OTU2-1f-2f = OTN optical rates 11.270/11.318 Gbit/s

**Fibre Channel rate options**

FC1X = 1x Fibre Channel interface<sup>b</sup>  
 FC2X = 2x Fibre Channel interface<sup>b</sup>  
 FC4X = 4x Fibre Channel interface<sup>b</sup>  
 FC8X = 8x Fibre Channel interface<sup>c</sup>  
 FC10X = 10x Fibre Channel interface<sup>c</sup>

**Ethernet rate options**

100optical = 100 Mbit/s optical<sup>b</sup>  
 GigE = 1000 Mbit/s optical and electrical<sup>b</sup>  
 10GigE = 10G LAN and 10G WAN<sup>c</sup>

Example: FTB-870-FLEX-SONET-155M-IPV6-GigE-FC1X-OTU1

**Notes**

- a. Always included.
- b. Requires purchase of SFP.
- c. Requires purchase of SFP+.

**ORDERING INFORMATION (ETHERNET ONLY)**

**FTB-860G-XX-XX-XX-XX-XX**

**Models**

FTB-860G-1 = Ethernet 10/100/1000 Base-T electrical and GigE optical  
 FTB-860G-10 = Ethernet 10 GigE LAN/WAN including 10/100 Base-T  
 FTB-860G-100 = Ethernet 10/100/1000 Base-T electrical, GigE optical  
 and 10 GigE LAN/WAN

**Ethernet rate options**

100optical = 100 Mbit/s optical <sup>a</sup>  
 GigE = 1000 Mbit/s optical and electrical <sup>a</sup>  
 10GigE = 10G LAN and 10G WAN <sup>b</sup>

**CPRI rate options**

CPRI 4.9G <sup>b</sup>  
 CPRI 6.1G <sup>b</sup>  
 CPRI 9.8G <sup>b</sup>

**Fibre Channel rate options**

FC1X = Enabled 1x Fibre Channel interface <sup>a</sup>  
 FC2X = Enables 2x Fibre Channel interface <sup>a</sup>  
 FC4X = Enables 4x Fibre Channel interface <sup>a</sup>  
 FC8X = Enables 8x Fibre Channel interface <sup>b</sup>  
 FC10X = Enables 10x Fibre Channel interface <sup>b</sup>

**Software options**

Cable\_test = Cable test  
 IPV6 = Internet protocol version 6  
 ETH-THRU = Enables Through mode capability <sup>c</sup>  
 CPRI-OBSAI = Enables 1.2G to 3.1G CPRI,  
 and 3.1G OBSAI <sup>a</sup>  
 MPLS = Enables MPLS  
 1588PTP = Generates and analyzes 1588 PTP  
 SyncE = Generates and analyzes SyncE protocol  
 TCP-THPUT = TCP throughput  
 ETH-OAM = Enables Y.1731, G.8113.1 (MPLS-TP), 802.1ag and MEF  
 ADV-FILTERS = Advanced filtering  
 ETH-CAPTURE = Full line-rate packet capture

Example: FTB-860G-100-IPV6-TCP-THPUT

**FTB-860-XX-XX-XX-XX-XX**

**Models**

FTB-860 = Ethernet 10/100/1000 Base-T electrical and GigE optical

**Ethernet rate option**

100optical = 100 Mbit/s optical <sup>a</sup>

**Software options**

Cable\_test = Cable test  
 IPV6 = Internet protocol version 6  
 ETH-THRU = Enables Through mode capability  
 CPRI-OBSAI = Enables 1.2G to 3.1G CPRI, and 3.1G OBSAI <sup>a</sup>  
 MPLS = Enables MPLS  
 1588PTP = Generates and analyzes 1588 PTP  
 SyncE = Generates and analyzes SyncE protocol  
 TCP-THPUT = TCP throughput  
 ETH-OAM = Enables Y.1731, G.8113.1 (MPLS-TP), 802.1ag and MEF  
 ADV-FILTERS = Advanced filtering  
 ETH-CAPTURE = Full line-rate packet capture

**Fibre Channel rate options**

FC1X = Enabled 1x Fibre Channel interface <sup>a</sup>  
 FC2X = Enables 2x Fibre Channel interface <sup>a</sup>  
 FC4X = Enables 4x Fibre Channel interface <sup>a</sup>

**CPRI rate options**

CPRI 4.9G <sup>b</sup>  
 CPRI 6.1G <sup>b</sup>

Example: FTB-860-IPV6-ETH-THRU-FC1X

**FTB-860GL-XX-XX**

**Models**

FTB-860GL = Ethernet 10/100/1000 electrical, GigE optical  
 and 10 GigE LAN/WAN

**Ethernet rate option**

100optical = 100 Mbit/s optical <sup>a</sup>

**Software options**

Cable\_test = Cable test  
 IPV6 = Internet protocol version 6

Example: FTB-860GL-IPV6-Cable\_test

**Notes**

- a. Requires purchase of SFP.
- b. Requires purchase of SFP+.
- c. Always included.

EXFO Headquarters > Tel.: +1 418 683-0211 | Toll-free: +1 800 663-3936 (USA and Canada) | Fax: +1 418 683-2170 | info@EXFO.com | [www.EXFO.com](http://www.EXFO.com)

EXFO serves over 2000 customers in more than 100 countries. To find your local office contact details, please go to [www.EXFO.com/contact](http://www.EXFO.com/contact).

EXFO is certified ISO 9001 and attests to the quality of these products. EXFO has made every effort to ensure that the information contained in this specification sheet is accurate. However, we accept no responsibility for any errors or omissions, and we reserve the right to modify design, characteristics and products at any time without obligation. Units of measurement in this document conform to SI standards and practices. In addition, all of EXFO's manufactured products are compliant with the European Union's WEEE directive. For more information, please visit [www.EXFO.com/recycle](http://www.EXFO.com/recycle). **Contact EXFO for prices and availability or to obtain the phone number of your local EXFO distributor.**

For the most recent version of this spec sheet, please go to the EXFO website at [www.EXFO.com/specs](http://www.EXFO.com/specs).

In case of discrepancy, the web version takes precedence over any printed literature.

