

IAP-6701-WG+

➤ **Industrial outdoor IEEE 802.11 b/g wireless access point with 1x10/100Base-T(X) PoE P.D., IP-67 grade**

Features

- WLAN interface supports up to 54Mbps link speed
- Various kinds of operation modes supported : AP/Bridge/Repeater/ AP-Client/Client mode
- Various kinds of encryption supported : WEP/WPA/WPA-PSK(TKIP,AES) /WPA2/ WPA2-PSK(TKIP,AES)/802.1X Authentication
- Supports **X-Roaming** < 100 ms
- Supports wireless load balance
- Wireless connecting status monitoring
- Versatile modes & event alarm by e-mail
- HTTPs & SSH protocol supported for secured management
- IP table to prevent access from unauthorized IP address
- IP Configurable by Windows utility (AP-Tool)



Introduction

IAP-6701-WG+ is a reliable IP-67 outdoor IEEE802.11b/g WLAN Access Point with 1 PoE P.D. Ethernet port. It can be configured to operate in AP/ Bridge/Repeater/AP-Client/Client mode. It is specifically designed for the toughest industrial environments. In combination with its IP-67 design and the superb management functionality, IAP-6701-WG+ provide a waterproof, and dust-tight connection. You are able to configure IAP-6701-WG+ by WEB interface via LAN port or WLAN interface. In addition, IAP-6701-WG+ also provides P.D. feature which is fully compliant with IEEE802.3af PoE P.D. specification to save the layout cost of power line. The IAP-6701-WG+ can be easily adopted in all kinds of applications and provides the most rugged solutions for managing your network in outdoor. Therefore, IAP-6701-WG+ is one of the best communication solutions for outdoor wireless applications.

Application

In practical operation of outdoor wireless access point, Windows utility (AP-Tool) is supported. This utility is very helpful for you to search and configure IP of access point on the industrial network.

In addition, the outdoor wireless access point support various kinds of operation modes include AP/ Bridge/Repeater/AP-Client mode. IAP-6701-WG+ also support PoE P.D. feature to extend the layout up to 100 meters. You can build up the wireless network easily.

Various Kinds of Operation Modes

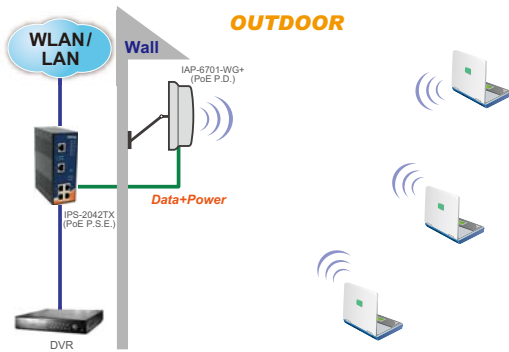

AP Mode

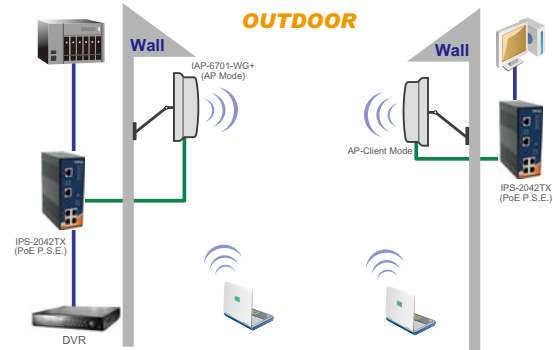

AP-Client Mode

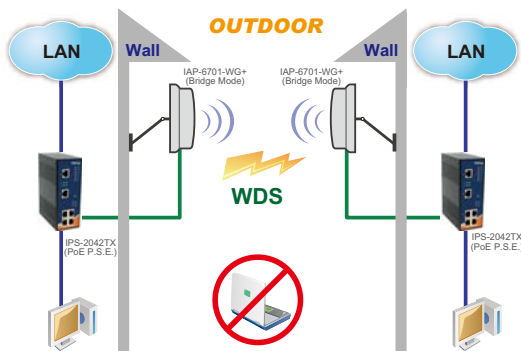

Bridge Mode

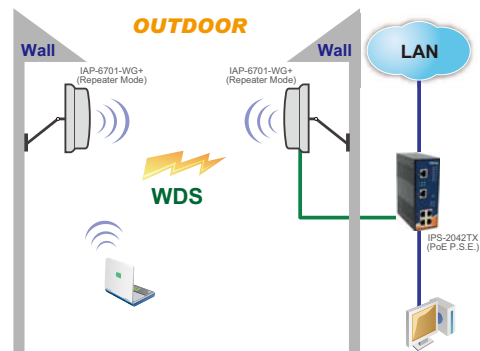

Repeater Mode

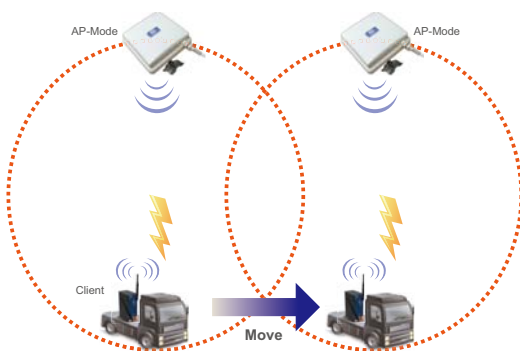

X-Roaming

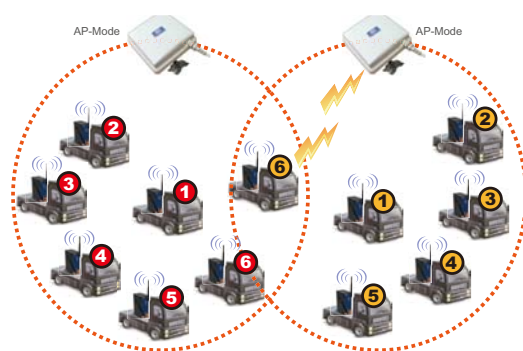

Wireless Load Balance

Dimensions

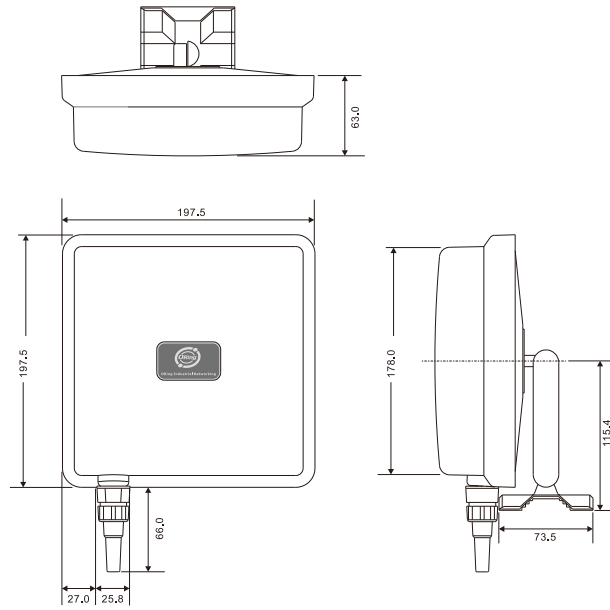

Unit=mm

Specifications

ORing WLAN Access Point Model	IAP-6701-WG+
Physical Ports	
10/100 Base-T(X) Ports in RJ45 Auto MDI/MDIX with PoE P.D.	1 Fully compliant with IEEE 802.3af Power Device specification Over load and short circuit protection Isolation Voltage : 1000VDC min. Isolation Resistance : 10 ⁸ ohms min
WLAN interface	
Operating Mode	AP/Bridge/Repeater/AP-Client/Client
Antenna	Built-in 12dBi panel antenna
Radio Frequency Type	DSSS, OFDM
Modulation	IEEE802.11b : CCK, DQPSK, DBPSK IEEE802.11g : OFDM with BPSK, QPSK, 16QAM, 64QAM
Frequency Band	America/FCC : 2.412~2.462 GHz (11channels) Europe CE/ETSI : 2.412~2.472 Ghz (13 channels)
Transmission Rate	IEEE802.11b : 1/ 2/ 5.5/ 11 Mbps IEEE802.11g : 6/ 9/ 12/ 18/ 24/ 36/ 48/ 54 Mbps
Transmit Power	IEEE802.11b : 20dBm IEEE802.11g : 17dBm
Receiver Sensitivity	-80dBm @ 11Mbps, PER< 8%; -65dBm @ 54Mbps, PER< 10%
Encryption Security	WEP : (64-bit, 128-bit key supported) WPA /WPA2 : IEEE802.11i(WEP and AES encryption) WPA-PSK (256-bit key pre-shared key supported) 802.1X Authentication supported TKIP encryption
Wireless Security	SSID broadcast disable
Protocol Support	
Protocol	ARP, BOOTP, DHCP, DNS, HTTPs, IP, ICMP, SNTP, TCP, UDP, RADIUS, SNMP, STP (IEEE 802.1D)

Power	
Input Power	48 VDC from PoE
Power Consumption (Typ.)	6 Watts
Physical Characteristics	
Enclosure	IP-67
Dimensions (W x D x H)	197.5(W) x 63(D) x 197.5(H) mm (7.80x6.34x7.80 inch.)
Weight (g)	1040 g
Environmental	
Storage Temperature	-40 to 85°C (-40 to 185°F)
Operating Temperature	-20 to 70°C (-4 to 158°F)
Operating Humidity	0~100% Non-condensing
Regulatory Approvals	
EMI	FCC Part 15, CISPR (EN55022) class A
EMS	EN61000-4-2 (ESD), EN61000-4-3 (RS), EN61000-4-4 (EFT), EN61000-4-5 (Surge), EN61000-4-6 (CS), EN61000-4-8, EN61000-4-11
Shock	IEC60068-2-27
Free Fall	IEC60068-2-32
Vibration	IEC60068-2-6
Safety	EN60950-1
Warranty	3 years

Ordering Information

IAP-67AA - BB C

Code Definition	LAN Port Number	WLAN Identification	PoE Identification
Option	- 1: 1 port	- WG : IEEE802.11 b/g mode	- " + ": PoE P.D. present

Available Model	Model Name	Description
	IAP-6701-WG+_US	Industrial outdoor IEEE 802.11 b/g wireless access point with 1x10/100Base-T(X) PoE P.D., IP-67 grade, US band
	IAP-6701-WG+_EU	Industrial outdoor IEEE 802.11 b/g wireless access point with 1x10/100Base-T(X) PoE P.D., IP-67 grade, EU band

Packing List

- IAP-6701-WG+
- Pillar-mount Kit
- Wall-mount Kit
- Ethernet Connection Kit
- ORing Tool CD
- Quick Installation Guide