



Low Frequency Measuring System

- Brief Overview of Phenomena.** .2
- Applicable Standards** .3
- Test System Overview.** .4
- Generator Specifications.** .9
- Accessories and Options.** 10
- EMC PARTNER's Product Range** 11

Brief Overview of Phenomena

Low Frequency (LF) Measuring System measures and simulates disturbances in the 230V/50Hz and 115V/60Hz public power supplies.

The following phenomena can be tested:

Emission

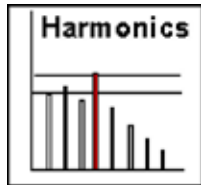

- Harmonics

The increasing use of electronic equipment fitted with switch mode power supplies has led to an increase in distortion of the public power supply. Such loads draw non sinusoidal current, which contains **harmonic** frequencies at multiples of the 50Hz and 60Hz supply frequencies. This can lead to significant currents flowing in the neutral conductor resulting in cable and transformer overheating. This is also known as „phantom power“ because it has to be transported through cables and transformers, but is not useful.

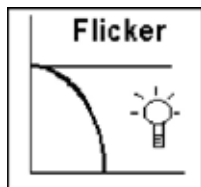

- Flicker

Small variations in the mains supply voltage, caused by fluctuating currents interacting with the mains impedance, influence the light intensity of an incandescent bulb. Light intensity fluctuates as a square of the RMS voltage. These cyclic fluctuations called „flicker“ are not noticed by the human eye but are registered by the brain, causing annoyance and increased stress. In extreme cases they can trigger headaches or epileptic attacks in susceptible people. Power factor correction is a simple means of reducing flicker.

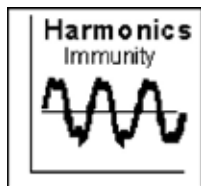

- Harmonics

Non linear loads connected to the public power supply generate harmonic and **interharmonic** currents which are transmitted throughout the power network to other equipment. Mains networks are also used to transmit control and monitoring signals. It is necessary to ensure that these unwanted frequency components do not cause disruption to control or measurement units.

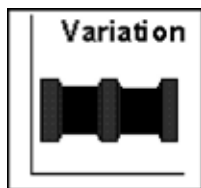

- Voltage variation

Changes in load conditions on the public power main, can cause voltage deviations both in a positive (overvoltage) and negative (undervoltage) direction. Equipment must be capable of maintaining normal operation during such deviations.

Applicable Standards

International Electrotechnical Committee (IEC)

IEC 61000-3-2 (Ed.3.2: 2009): Limits - Limits for harmonic current emissions (equipment input current ≤ 16 A per phase)

IEC 61000-3-3 (Ed.2.0: 2008): Limits - Limitation of voltage changes, voltage fluctuations and flicker in public low-voltage supply systems, for equipment with rated current ≤ 16 A per phase and not subject to conditional connection

IEC 61000-4-7 (Ed.2.1: 2009): Testing and measurement techniques - General guide on harmonics and interharmonics measurements and instrumentation, for power supply systems and equipment connected thereto

IEC 61000-4-15 (Ed.1.1: 2003): Testing and measurement techniques - Flickermeter - Functional and design specifications

IEC/TR 60725 (Ed.2.0: 2005): Consideration of reference impedances and public supply network impedances for use in determining disturbance characteristics of electrical equipment having a rated current ≤ 75 A per phase

IEC 61000-4-13 (Ed.1.1: 2009): Testing and measurement techniques - Harmonics and interharmonics including mains signalling at a.c. power port, low frequency immunity tests.

IEC 61000-4-14 (Ed.1.2: 2009): Testing and measurement techniques - Voltage fluctuation immunity test.



Test System Overview

Test System Features

LF Measuring System has many unique and outstanding features:

- Utilises public power main
- Light weight and transportable
- Unique power amplifier design (patent pending)
- 4000VA rated system
- 250V maximum EUT supply
- 16A per phase maximum EUT current
- Power source continuously monitored for compliance
- Discrete components for flicker impedance
- Flicker measurements P_{st} and P_{it}
- d_{max} measurements
- Automatic Pass/Fail indication
- Powerful analysis software
- Lower cost solution compared to conventional systems
- System verification built-in
- Compact 19" bench top or rack mount design
- Fulfills **all** the latest standard requirements
- Remote control and software upgrade through standard interface
- Easily expandable to 3-phase measurement system
- 2 year warranty

User Benefits

The technical excellence and many unique features of LF Measuring System translates directly into benefits for the user

- Cost effective solution to meet many test requirements
- Increase quality of test object
- Independant of local mains supply (with separate AC source option)
- Save operator time with the automated test routines and test report facility
- Easy retrieval of test data
- Unparalleled reliability and system up-time
- Test Assistant

System Components

The Low Frequency measuring system is a compact solution to determine harmonic and flicker emissions generated by equipment connected to the public power main.

HAR1000-1P is the single phase version and comprises a power amplifier, line impedance network, harmonics and flicker measurement, all in a single unit. HAR-EXT1000 added to HAR1000-1P provides full three phase capability.

The hardware is controlled from a powerful user interface software (HARCS).



HAR1000-1P

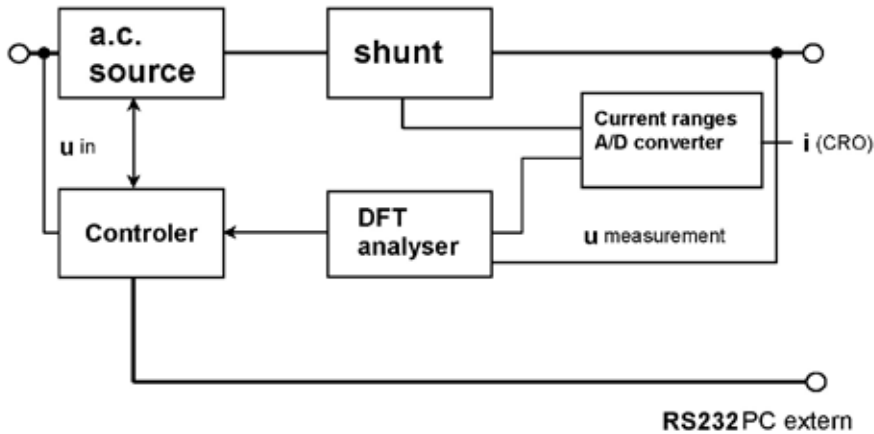

Power Amplifier

Using a novel technique to correct power main distortion reduces size, weight and cost compared to traditional systems. A small power amplifier is used to correct power main distortion and deliver a clean sine wave to an EUT. While the measurements are being made, the test voltage (U) at the terminals of the equipment under test, when operated according to the defined operating condition, shall meet the requirements laid down in the IEC standards.

The power amplifier source impedance must be nearly 0ohm to prevent distortion of flicker results. The test voltage must be stable in amplitude and frequency to ensure correct results.

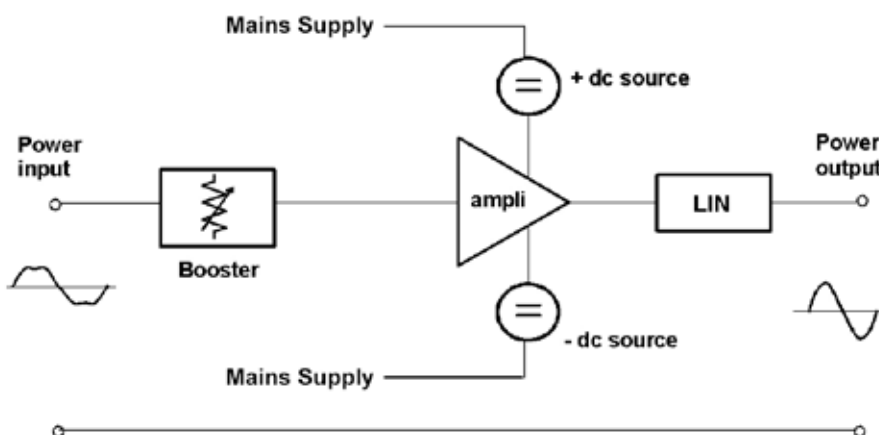

Line Impedance Network

Flicker measurements are small variations of RMS voltage caused by the EUT. In order to ensure that only effects from the EUT are measured, a conventional impedance of $0,4\text{ohm} + j 0,25\text{ohm}$ must be used. This is a real impedance included in the system.

Harmonic Measurement System

This can be configured to measure in accordance with the latest standard requirements (including amendment 14) and also the previous version. Providing an easy comparison of measurement results obtained from previous and new samples. Dual analysers simultaneously monitor the AC supply output and the distortion resulting from the EUT. Both voltage and current harmonics are measured and displayed for analysis purposes

Definition of the equipment classes

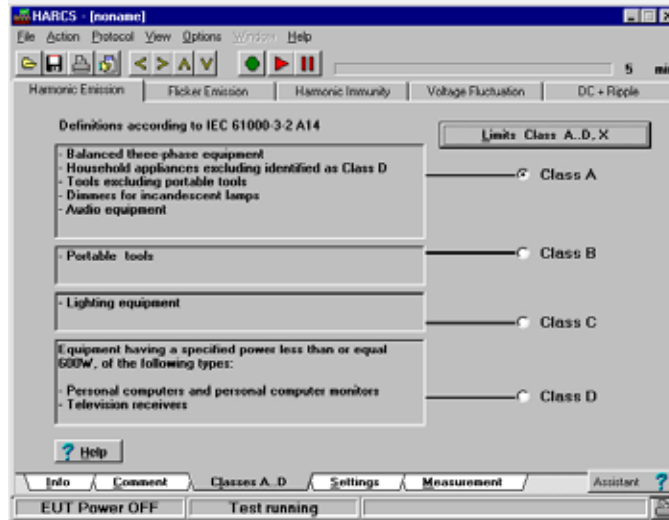

Display of single phase harmonic voltage and current (left)

Harmonic results table including real time EUT measurements (right)

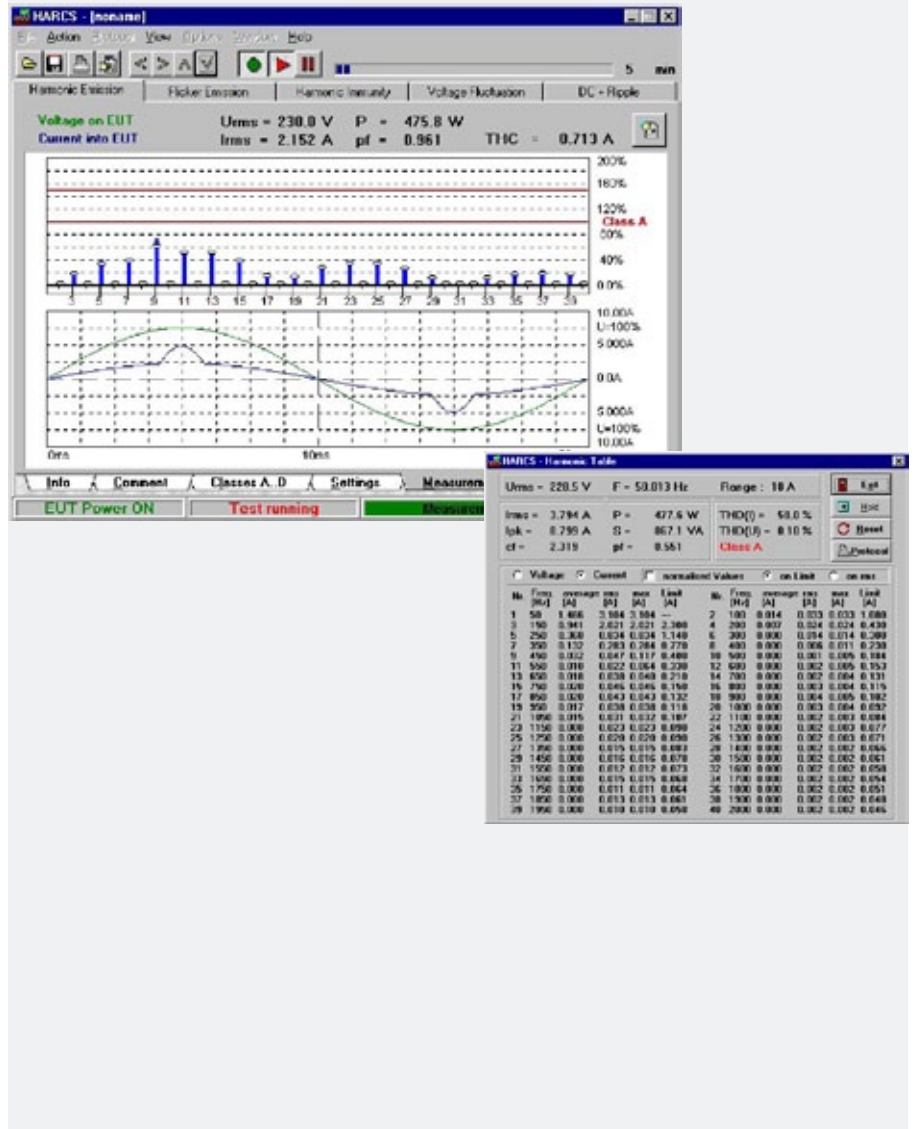

Flicker Measurement System

The flicker analyser is a part of the system hardware and is compliant to the latest requirements of IEC61000-4-15. Specifically this means that d_{max} is the result of an average from 22 measurements taken from a total of 24. Verification of the flicker measurement system can be made using 33.3Hz modulation for 50Hz and also 40Hz modulation for 60Hz supplies. The inrush current capability enables measurement of d_{max} at 7%.

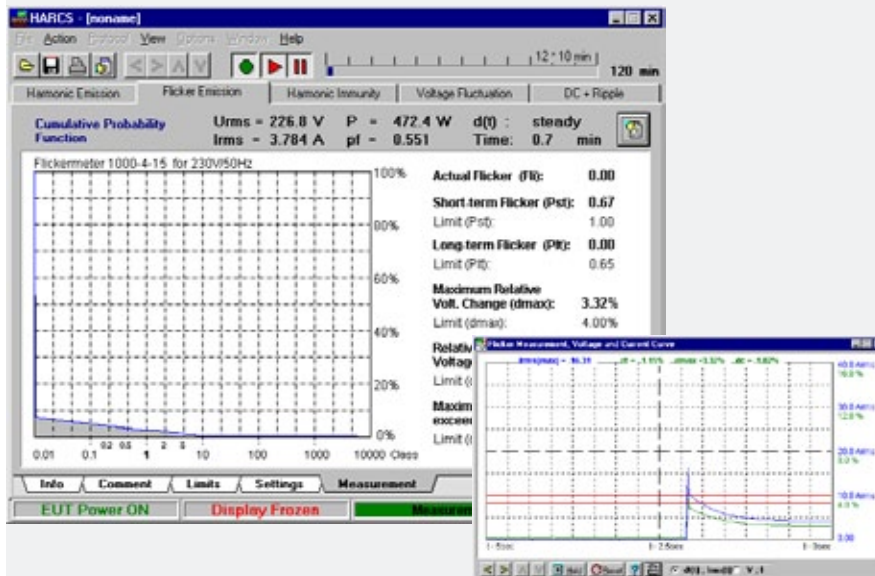

Graphic representation of cumulative probability function. The real time flicker value is displayed together with all the measurements required for standard compliance. (left)

Display of d_{max} value showing amplifier in-rush capability (right)

HARCS software

Provided as part of the system package, HARCS software is a powerful user friendly interface which allows the user to configure the system to perform measurements and displays the results in a convenient format. Unique features of HARCS software include:

- Test Assistant
- Harmonics inspector
- Recorder function
- ANASIM
- Harmonic verification
- Flicker verification

Upgrading the HARCS to include the immunity package, provides a low cost means to perform additional testing for harmonic immunity, voltage fluctuations and ripple on DC supplies.

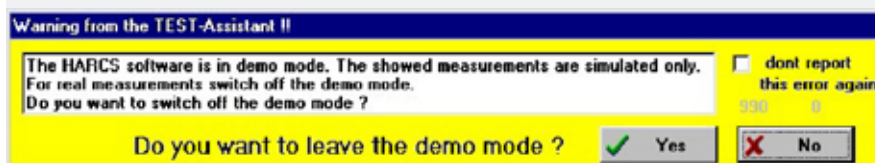

Test Assistant

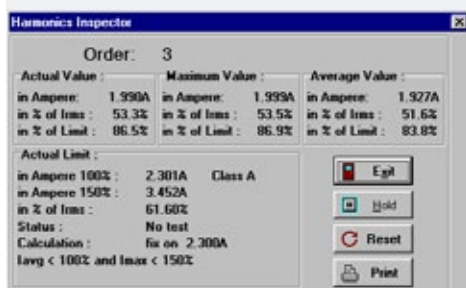

Harmonics Inspector. Select individual harmonics to view additional information in real time.

HARCS Recorder. Up to 8 different measurement parameters can be stored in the recorder. When a test is completed, data from the recorder can be “re-run” to assist in analysis of measurement results.

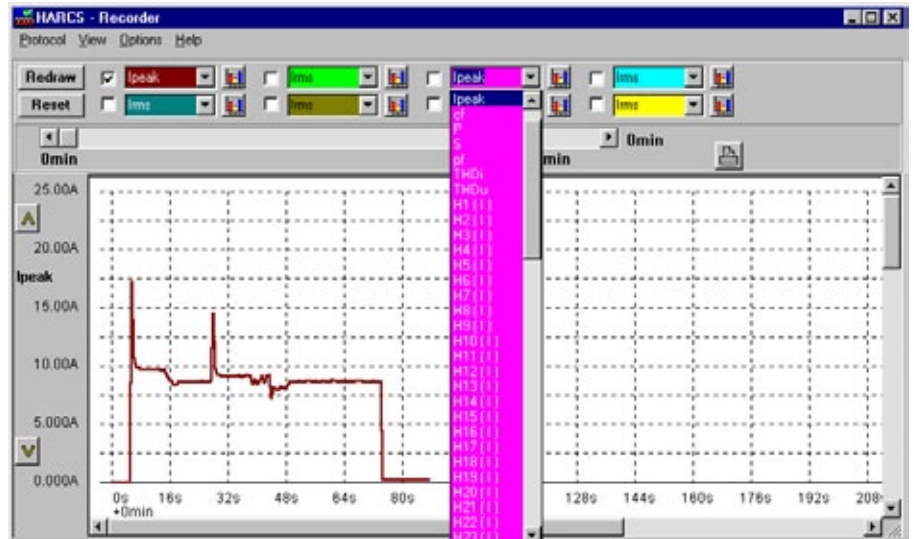

HARCS ANASIM. Included in the HARCS package is the simulation program ANASIM.

Verification. Perform a quick system verification for harmonics and flicker using internally generated signals.

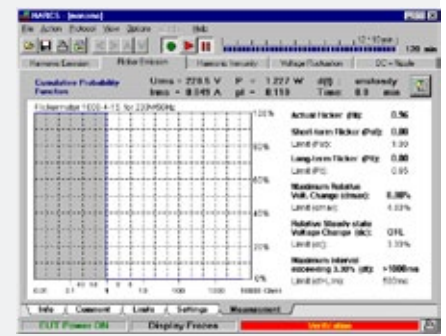

Generator Specifications

Power Amplifier

Power rating	4000VA
Amplifier bandwidth	DC to 6000Hz
Voltage range (230V)	200 to 250V
Voltage range (115V)	100 to 125V
Continuous current	16A
Usable supply frequencies	50/60Hz
Inrush current	500A at 230V
Load change regulation	< 0.05%
Total Harmonic Distortion (THD)	< 0.5%
Response time 0 to 100% load change	10µs
Voltage harmonic distortions	3rd harmonic < 0.9% 5th harmonic < 0.4% 7th harmonic < 0.3% 9th harmonic < 0.2% 2nd - 10th harmonic < 0.2% 11th - 40th harmonic < 0.1%
Source impedance	< 3mohm

Harmonic Measurement System

Current and Voltage harmonic range	1st to 40th harmonic
Harmonic class measurements	A, B, C, D & X
Frequency measurement accuracy	< 0.1%
Voltage drop across current shunt	< 150mV
Current ranges	auto, 0.25A, 0.5A, 1A, 2A, 5A, 10A, 25A & 50A
Current measurement accuracy	< 1%
Parameter measurement and display	Urms, Upeak, Irms, Ipeak, Crest factor, Power, Apparent power, Frequency, UTHD & ITHD
FFT of EUT current	real time 4096 points over 16 periods
Fluctuating harmonics	16 periods (50 or 60Hz) with 1.5s filter

Flicker Measurement System

50Hz Line Impedance Network 1 phase	0.4ohm + j0.25ohm (phase & neutral)
50Hz Line Impedance Network 1 phase	0.24ohm + j0.15ohm (phase only)
50Hz Line Impedance Network 1 phase	0.16ohm + j0.10ohm (neutral only)
50Hz Line Impedance Network 3 phase	0.24ohm + j0.15ohm (phase only)
50Hz Line Impedance Network 3 phase	0.16ohm + j0.10ohm (neutral only)
Flicker meter	according to IEC61000-4-15
Flicker measurements per second	100
Parameter measurement and display	Urms, Irms, Power, Power factor, Frequency, Pst, Plt, dmax, dc & dt
Flicker displays	Cumulative probability, histogram
Automatic Pass/Fail indication for	Pst, Plt, dmax, dc & dt

Mains Supply Requirements

230V/115V	± 10%
50Hz/60Hz	± 0.5% for 9A range and 16A range

Accessories and Options

HAR-EXT1000 with HAR1000-1P and Laptop



Simultaneous display of three phase harmonics

HAR1000-1P can be enhanced with the following accessories:

HAR-EXT1000

Adds two further phases to the HAR1000-1P. Simple connection without any hardware modifications mean this powerful extension can be added at any time to an existing single phase system.



HARCS Immunity Software

This package can be added to the single phase system. It extends the system's emission capability to include power line immunity tests such as harmonic immunity and voltage fluctuations.

Easy selection of test sequences (left)

Immunity measurement of one phase system in real time (right)

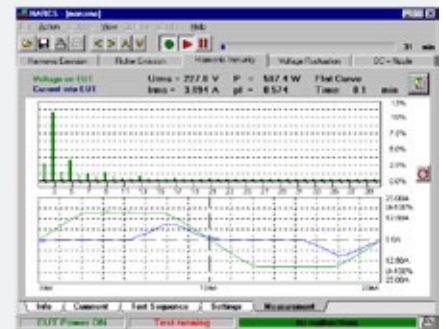
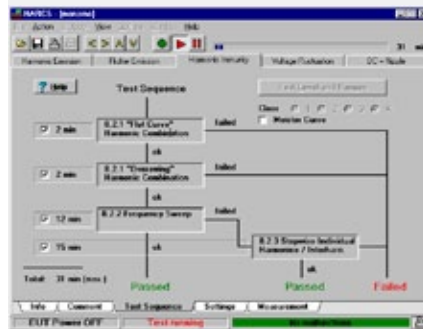

PS3



PS3

Low cost power source to provide alternative supply to local main. PS3-1 is available with up to 3 voltage/frequency combinations.

230V/50Hz	3000W
115V/60Hz	2000W

USB Serial Cable

The UC-232A USB Serial adapter provides an external plug-and-play RS-232 serial connection for computers and notebooks that support USB specification.

EMC PARTNER's Product Range

The Largest Range of Impulse Test Equipment up to 100kA and 100kV.

Immunity Tests

Transient Test Systems for all EMC tests on electronic equipment. ESD, EFT, surge, AC dips, AC magnetic field, surge magnetic field, common mode, damped oscillatory and DC dips. According to IEC and EN 61000-4-2, -4, -5, -8, -9, -10, -11, -12, -16, -18, -19, -29.

Lightning Tests

Impulse test equipment and accessories for aircraft, military and telecom applications. Complete solutions for RTCA / DO-160 and EUROCAE / ED-14 for indirect lightning on aircraft systems, MIL-STD-461 tests CS106, CS115, CS116 and Telecom, ITU-T .K44 basic and enhanced tests for impulse, power contact and power induction.

Component Tests

Impulse generators for testing; varistors, gas discharge tubes (GDT), surge protective devices (SPDs), X / Y capacitors, circuit breakers, watt-hour meters, protection relays, insulation material, suppressor diodes, connectors, chokes, fuses, resistors, emc-gaskets, cables, etc.

Emission Measurements

Measurement of Harmonics and Flicker in 1-phase and 3-phase electrical and electronic products according to IEC /EN 61000-3-2 and 61000-3-3 . HARCS Immunity software adds interharmonic tests, voltage variation and ripple on DC tests according to IEC/EN 61000-4-13, -4-14, -4-17.

System Automation

A full range of accessories enhance the test systems. Test cabinets, test pistols, adapters and remote control software, simplify interfacing with the EUT.

Programmable PSU, EMC hardened for frequencies from 16.7Hz to 400Hz. Frequency PS3-SOFT-EXT complies with IEC / EN 61000-4-14 and -4-28.

Service

Our commitment starts with a quality management system backing up our ISO 17025 accreditation. With the SCS number 129, EMC PARTNER provide accredited calibration and repairs. Our customer support team are at your service!

