



## **IAR-142/142+ -4G Series IEEE 802.11 a/b/g/n Cellular Router**

### **User Manual**

Version 1.1

May, 2015

[www.oring-networking.com](http://www.oring-networking.com)

## COPYRIGHT NOTICE

Copyright © 2015 ORing Industrial Networking Corp.

All rights reserved.

No part of this publication may be reproduced in any form without the prior written consent of ORing Industrial Networking Corp.

## TRADEMARKS

**ORing** is a registered trademark of ORing Industrial Networking Corp.

All other trademarks belong to their respective owners.

## REGULATORY COMPLIANCE STATEMENT

Product(s) associated with this publication complies/comply with all applicable regulations. Please refer to the Technical Specifications section for more details.

## WARRANTY

ORing warrants that all ORing products are free from defects in material and workmanship for a specified warranty period from the invoice date (5 years for most products). ORing will repair or replace products found by ORing to be defective within this warranty period, with shipment expenses apportioned by ORing and the distributor. This warranty does not cover product modifications or repairs done by persons other than ORing-approved personnel, and this warranty does not apply to ORing products that are misused, abused, improperly installed, or damaged by accidents.

Please refer to the Technical Specifications section for the actual warranty period(s) of the product(s) associated with this publication.

## DISCLAIMER

Information in this publication is intended to be accurate. ORing shall not be responsible for its use or infringements on third-parties as a result of its use. There may occasionally be unintentional errors on this publication. ORing reserves the right to revise the contents of this publication without notice.

## CONTACT INFORMATION

ORing Industrial Networking Corp.

3F., NO.542-2, Jhongjheng Rd., Sindian District, New Taipei City 231, Taiwan, R.O.C.

Tel: + 886 2 2218 1066 // Fax: + 886 2 2218 1014

Website: [www.oring-networking.com](http://www.oring-networking.com)

Technical Support

E-mail: [support@oring-networking.com](mailto:support@oring-networking.com)

Sales Contact

E-mail: [sales@oring-networking.com](mailto:sales@oring-networking.com) (Headquarters)

[sales@oring-networking.com.cn](mailto:sales@oring-networking.com.cn) (China)

# Tables of Content

<b>Getting Started.....</b>	<b>3</b>
1.1    About the IAR-142(+)-4G .....	3
1.2    Software Features .....	3
1.3    Hardware Features.....	3
 <b>Hardware Overview .....</b>	 <b>5</b>
2.1    Front Panel.....	5
2.1.1    Ports and Connectors.....	5
2.2    Front Panel LEDs .....	6
2.3    Rear Panel .....	6
2.4    Top Panel .....	7
 <b>Hardware Installation .....</b>	 <b>8</b>
3.1    DIN-rail Installation .....	8
3.2    Wall Mounting .....	9
3.3    Wiring .....	10
3.3.1    Grounding .....	10
3.3.2    Dual Power Inputs .....	10
 <b>Cables and Antenna .....</b>	 <b>12</b>
4.1    Ethernet Cables.....	12
4.2    RJ-45 Pin Assignment.....	12
4.3    Wireless Antenna.....	13
4.4    Cellular Antenna .....	13
 <b>Management Interface.....</b>	 <b>14</b>
5.1    Installation .....	14
5.2    Configuration.....	15
5.2.1    Basic Setting.....	16
WAN .....	16
LAN.....	21
DHCP.....	22
DHCP Client List.....	24
Wireless LAN.....	24
DDNS .....	30
Date & Time .....	31
5.2.2    Networking Setting.....	32
Wireless Setting.....	32
NAT Setting.....	35
Firewall Setting .....	38
VPN Setting .....	40
Routing Protocol.....	43

5.2.3	System Tools.....	45
	Login Setting.....	45
	Router Restart.....	46
	Firmware Upgrade.....	46
	Save/Restore Configurations.....	47
	Remote Management.....	48
	Miscellaneous.....	49
	Event Warning Setting.....	50
5.2.4	System Status.....	54
	System Info.....	54
	System Log.....	54
	Traffic Statistics.....	55
	Wireless Link List.....	55
	<b>Technical Specifications.....</b>	<b>56</b>
	<b>Compliance.....</b>	<b>58</b>

# **Getting Started**

## **1.1 About the IAR-142(+)-4G**

The IAR-142-/142+-4G is a reliable IEEE 802.11 b/g/n WLAN VPN router with two 10/100Base-T(X) ports where one is for LAN and the other one for WAN. It supports 802.1X and MAC filter for security control and can be operate in three routing modes: Dynamic/Static IP Route, PPPoE Authentication, and Modem Dial-up. In the mode of Modem Dial-up, it supports GPRS/3G/3.5G/LTE modem via the internal 4G module. You can set up a WLAN environment that fulfills demands of various applications by dialing up cellular modems. In addition, the WAN port of IAR-142+-4G is P.D.-enabled which is fully compliant with IEEE802.3af PoE specification. This feature extends the layout up to 100 meters.

## **1.2 Software Features**

- High speed air connectivity: WLAN interface supports up to 150Mbps link speed.
- HNAT support for enhanced LAN-to-WAN routing performance
- Supports multiple security methods for higher security: WEP/WPA/WPA-PSK(TKIP,AES)/WPA2/WPA2-PSK(TKIP,AES)/802.1X authentication
- Secure management by HTTPS
- Multiple WAN connection types supported: Dynamic/Static IP, PPPoE, Modem/Dial-up
- IP table to prevent access from unauthorized IP address
- Supports NAT setting (virtual server, port trigger, DMZ, and UPnP)
- Versatile modes & event alarm by e-mail
- Event warning by Syslog, e-mail, SNMP trap, relay output, and beeper

## **1.3 Hardware Features**

- 2 x 10/100Base-T(X) Ethernet ports for WAN / LAN connection individually.
- 1 x SIM card slot
- 4G LTE dial-up modem included
- 1KV isolation for PoE P.D. port (IAR-142+-4G)
- Dual DC inputs
- Operating temperature: -10 to 60°C
- Storage temperature: -40 to 85°C
- Operating humidity: 5% to 95%, non-condensing
- DIN-Rail and Wall-mount enabled

- Casing: IP-30
- Dimensions: 45(W)x80.6(D)x95(H) mm

# Hardware Overview

## 2.1 Front Panel

### 2.1.1 Ports and Connectors

The router is equipped with the following ports and features on the front panel.

Port	Description
<b>10/100Base-T(X) Fast Ethernet Ports</b>	10/100Base-T(X) RJ-45 fast Ethernet ports supporting auto-negotiation. Default setting including Speed: auto Duplex: auto ETH1 (LAN port) of the IAR-142+-4G is compliant with IEEE802.3af PoE standard and can be connected to PoE switches.*
<b>ANT.</b>	1 x reversed SMA connector for WiFi antenna and 2 x SMA connector for cellular antenna.

\*Note: For PoE Ethernet switch options, please refer to information on the ORing IPS series.

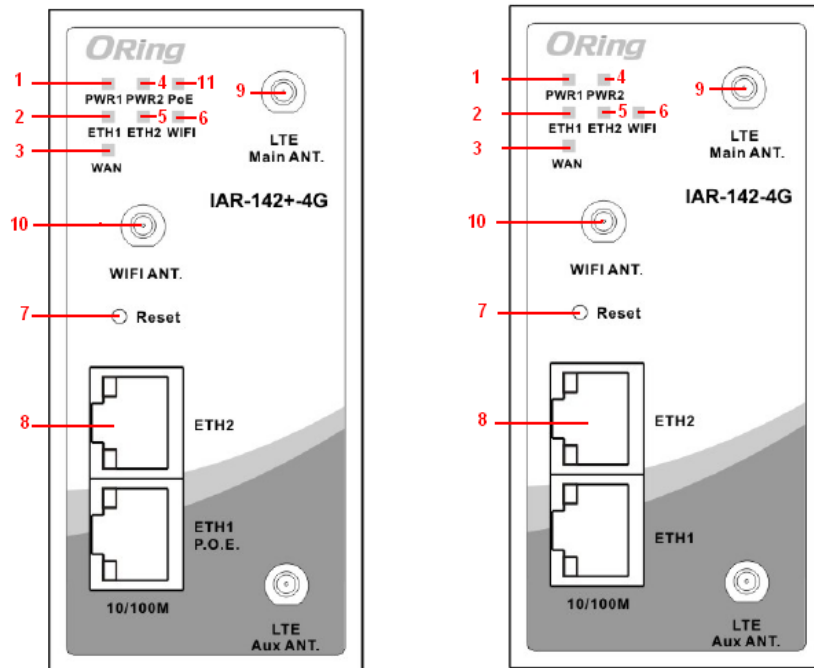

- 1. Power 1 LED
- 2. 1st LAN port LED
- 3. WAN port LED
- 4. Power 2 LED
- 5. 2nd LAN port LED
- 6. Wi-Fi status LED
- 7. Reset button
- 8. Ethernet ports (ETH1 as LAN port; ETH2 as WAN port)
- 9. LTE antenna connector
- 10. Wi-Fi antenna connector
- 12. PoE indicator

## 2.2 Front Panel LEDs

LED	Color	Status	Description
PWR1	Green	On	DC power 1 activated
PWR2	Green	On	DC power 2 activated
PoE	Green	On	Power is supplied over Ethernet cable
ETH1	Green	On	Port is linked and running at 100Mbps
		Blinking	Data being transmitted
ETH2	Green	On	Port is linked and running at 100Mbps
		Blinking	Data being transmitted
WLAN	Green	On	WLAN is activated
WAN	Green	On	Modem ready

## 2.3 Rear Panel

On the rear panel of the router sit three sets of screw holes. The two sets placed in triangular patterns on both ends of the rear panel are used for wall-mounting (red boxes in the figure below) and the set of four holes in the middle are used for Din-rail installation (blue box in the figure below). For more information on installation, please refer to [3.1 Din-rail Installation](#).

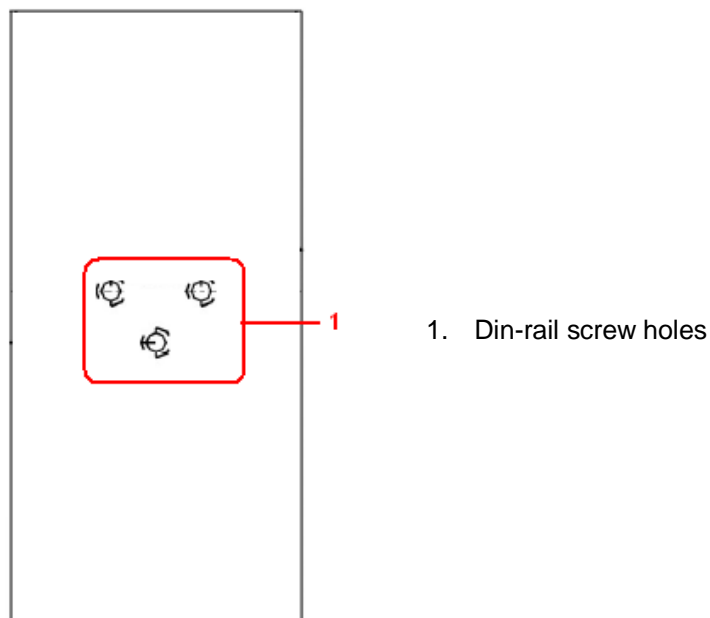



## 2.4 Top Panel

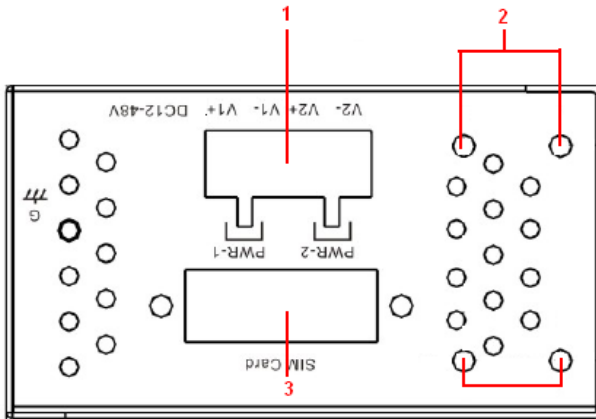

1. Terminal block
2. Wall-mount screw holes
3. SIM card slot

# Hardware Installation

## 3.1 DIN-rail Installation

The router comes with a DIN-rail kit to allow you to fasten the router to a DIN-rail in any environments.

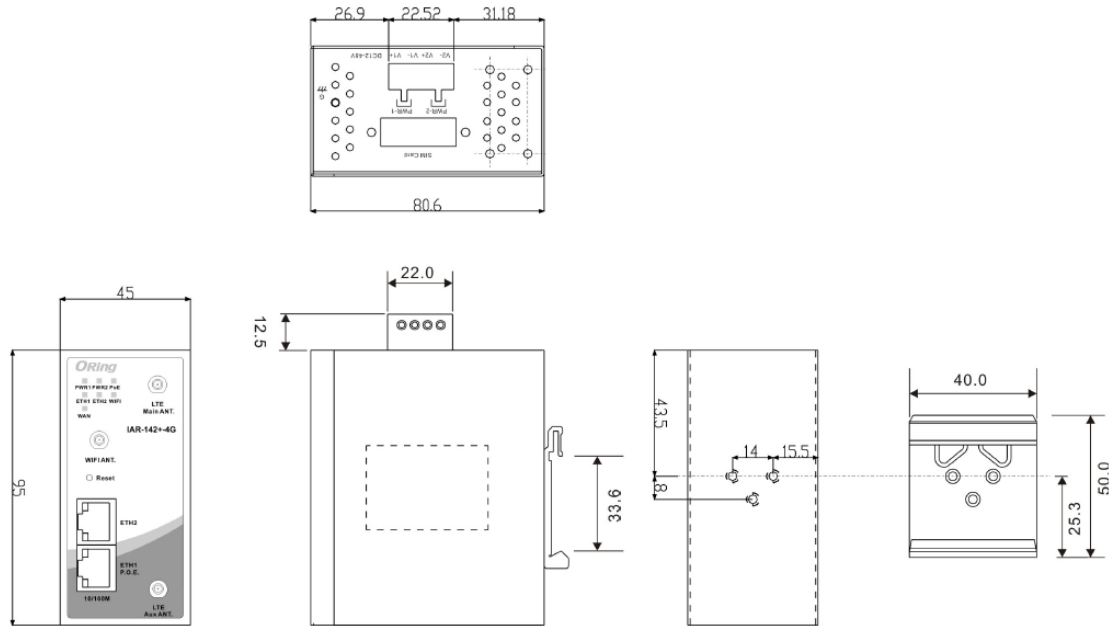

**DIN-rail Kit Measurement (Unit = mm)**

**Step 1:** Slant the router and screw the Din-rail kit onto the back of the router, right in the middle of the back panel.

**Step 2:** Slide the router onto a DIN-rail from the Din-rail kit and make sure the router clicks into the rail firmly.

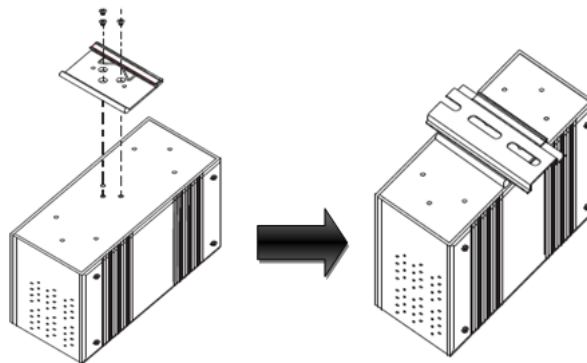

### 3.2 Wall Mounting

Besides Din-rail, the router can be fixed to the wall via a wall mount panel, which can be found in the package.

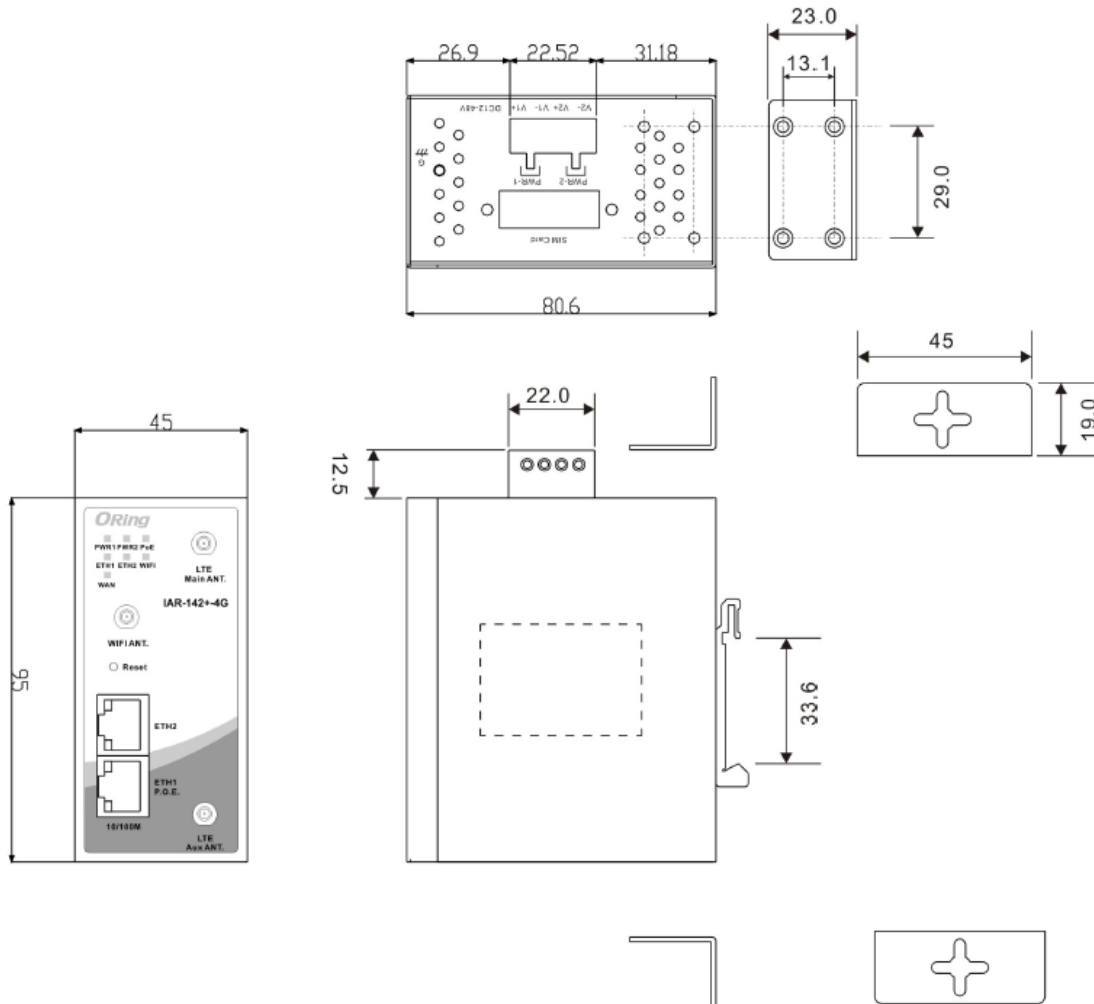

Wall-Mount Kit Measurement (Unit = mm)

To mount the router onto the wall, follow the steps:

**Step 1:** Screw the two pieces of wall-mount kits onto both ends of the rear panel of the router. A total of six screws are required, as shown below.

**Step 2:** Use the router, with wall mount plates attached, as a guide to mark the correct locations of the four screws.

**Step 3:** Insert a screw head through the large part of the keyhole-shaped aperture on the plate, and then slide the router downwards. Tighten the four screw for added stability.

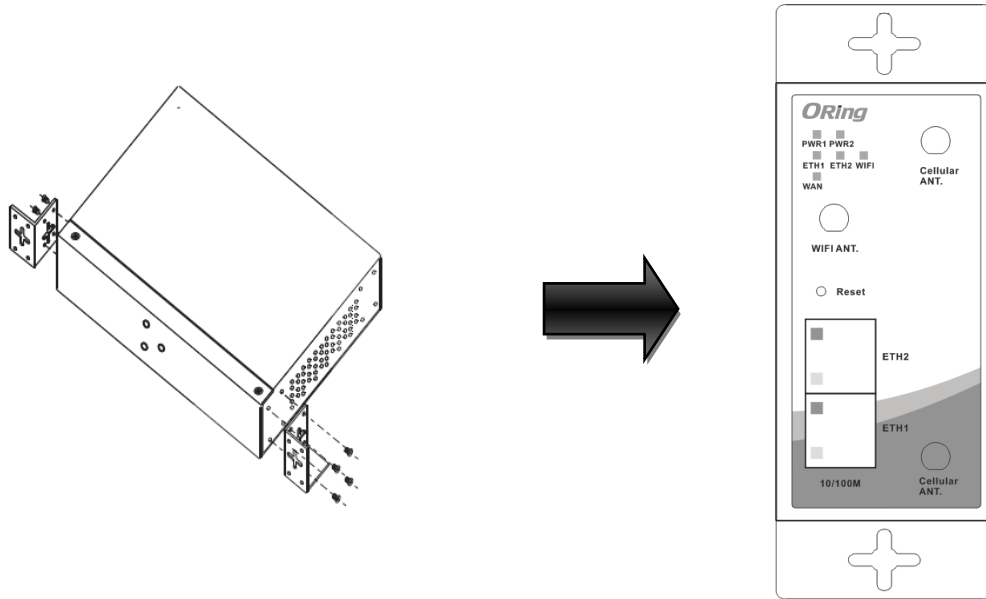

The screws should be 6mm diameter head x 3mm diameter thread, as shown below. Note that the screws should not be larger than the size used in the series to prevent damaging the router.

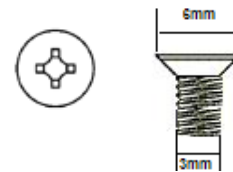

### 3.3 Wiring



**WARNING**

Be sure to switch off the power and make sure the area is not hazardous before disconnecting modules or wires. The devices may only be connected to the supply voltage shown on the type plate.

#### 3.3.1 Grounding

Grounding and wire routing help limit the effects of noise due to electromagnetic interference (EMI). Run the ground connection from the ground screw to the grounding surface prior to connecting devices.

#### 3.3.2 Dual Power Inputs

The router has two sets of power inputs, power input 1 and power input 2, on a 4-pin terminal block on the router's top panel. Follow the steps below to wire redundant power inputs.

**Step 1:** insert the negative/positive DC wires into the V-/V+ terminals, respectively.

**Step 2:** to keep the DC wires from pulling loose, use a small flat-blade screwdriver to tighten the wire-clamp screws on the front of the terminal block connector.

**Note:** besides power input, the router can also be powered by a PoE PSE such as switch via its PoE-enabled LAN port.

**ATTENTION**

1. Be sure to disconnect the power cord before installing and/or wiring your routers.
  2. Calculate the maximum possible current in each power wire and common wire. Observe all electrical codes dictating the maximum current allowable for each wire size.
  3. If the current goes above the maximum ratings, the wiring could overheat, causing serious damage to your equipment.
  4. Use separate paths to route wiring for power and devices. If power wiring and device wiring paths must cross, make sure the wires are perpendicular at the intersection point.
  5. Do not run signal or communications wiring and power wiring through the same wire conduit. To avoid interference, wires with different signal characteristics should be routed separately.
  6. You can use the type of signal transmitted through a wire to determine which wires should be kept separate. The rule of thumb is that wiring sharing similar electrical characteristics can be bundled together
  7. You should separate input wiring from output wiring
  8. It is advised to label the wiring to all devices in the system
-

# Cables and Antenna

## 4.1 Ethernet Cables

The device has two 10/100Base-T(X) Ethernet ports. According to the link type, the AP uses CAT 3, 4, 5, 5e, 6 UTP cables to connect to any other network device (PCs, servers, switches, routers, or hubs). Please refer to the following table for cable specifications.

Cable Types and Specifications

Cable	Type	Max. Length	Connector
10BASE-T	Cat. 3, 4, 5 100-ohm	UTP 100 m (328 ft)	RJ-45
100BASE-T(X)	Cat. 5 100-ohm UTP	UTP 100 m (328 ft)	RJ-45

## 4.2 RJ-45 Pin Assignment

With 10/100Base-T(X) cables, pins 1 and 2 are used for transmitting data, and pins 3 and 6 are used for receiving data.

10/100 Base-T(X) RJ-45 Pin Assignments :

Pin Number	Assignment
1	TD+
2	TD-
3	RD+
4	P.O.E. power input +
5	P.O.E. power input +
6	RD-
7	P.O.E. power input -
8	P.O.E. power input -

The router also supports auto MDI/MDI-X operation. You can use a straight-through cable to connect PC and router. The following table below shows the 10/100BASE-T(X) MDI and MDI-X port pin outs.

MDI/MDI-X pins assignment

Pin Number	MDI port	MDI-X port
1	TD+(transmit)	RD+(receive)
2	TD-(transmit)	RD-(receive)
3	RD+(receive)	TD+(transmit)
4	P.O.E. power input +	P.O.E. power input +
5	P.O.E. power input +	P.O.E. power input +
6	RD-(receive)	TD-(transmit)
7	P.O.E. power input -	P.O.E. power input -
8	P.O.E. power input -	P.O.E. power input -

**Note:** "+" and "-" signs represent the polarity of the wires that make up each wire pair.

### 4.3 Wireless Antenna

The router provides a reversed SMA connector for 2.4GHz antennas. You can also use external RF cables and antennas with the connectors.

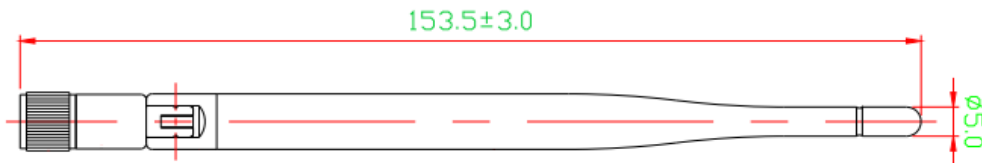

### 4.4 Cellular Antenna

The router provides one SMA connector for cellular antennas. External RF cables and antennas can also be used with the connector.

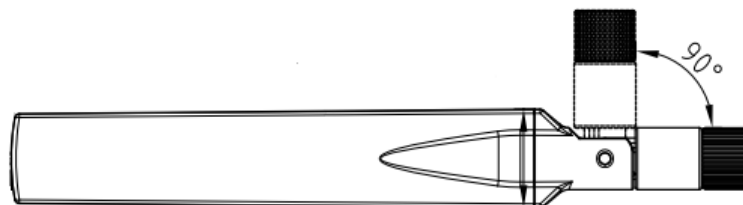

# Management Interface

## 5.1 Installation

Before installing the router, you need to be able to access the router via a computer equipped with an Ethernet card or wireless LAN interface. To simplify the connection, it is recommended to use an Ethernet card to connect to a LAN.

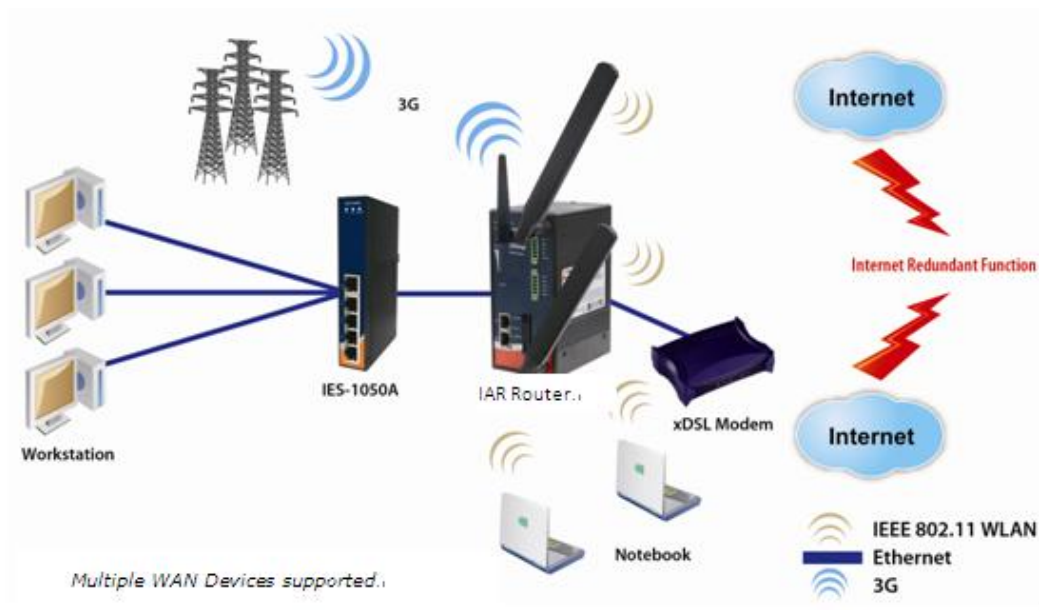

Follow the steps below to install and connect the router to PCs:

**Step 1:** Select power source. The router can be powered by +12~48V DC power input, or via a PoE (Power over Ethernet) PSE Ethernet switch.

**Step 2:** Connect a computer to the router. Use either a straight-through Ethernet cable or cross-over cable to connect the ETH1 port of the router to a computer. Once the LED of the LAN port lights up, which indicates the connection is established, the computer will initiate a DHCP request to retrieve an IP address from the AP router.

**Step 3:** Configure the router on a web-based management utility. Open a web browser on your computer and type <http://192.168.10.1> (default gateway IP of the router) in the address box to access the webpage. A login window will pop up where you can enter the default login name admin and password admin. For security reasons, we strongly recommend you to



change the password. Click on **System Tools > Login Setting** after logging in to change the password.

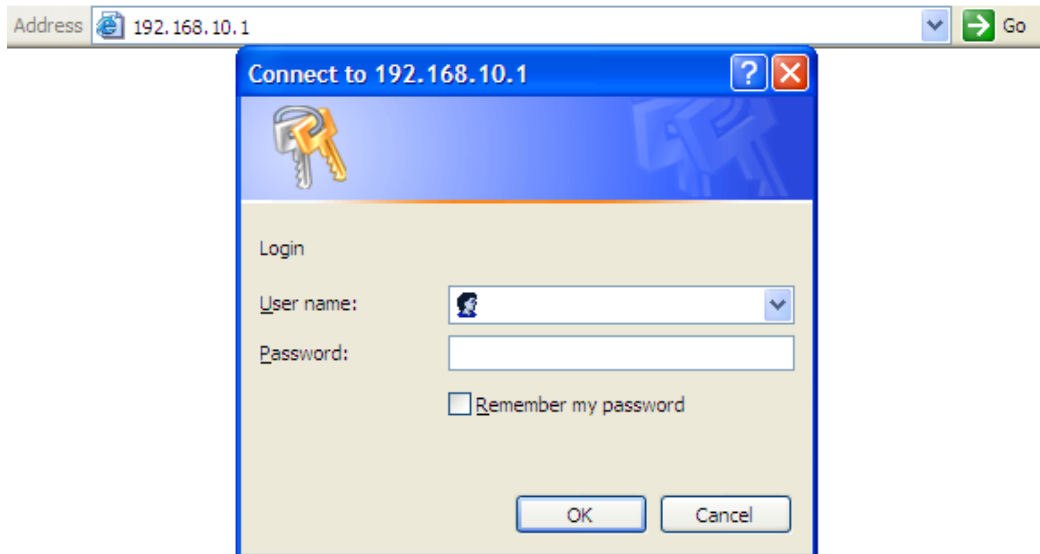

After you log in successfully, a Web interface will appear, as shown below. On the left hand side of the interface is a list of functions where you can configure the settings. The details of the configurations will be shown on the right screen.

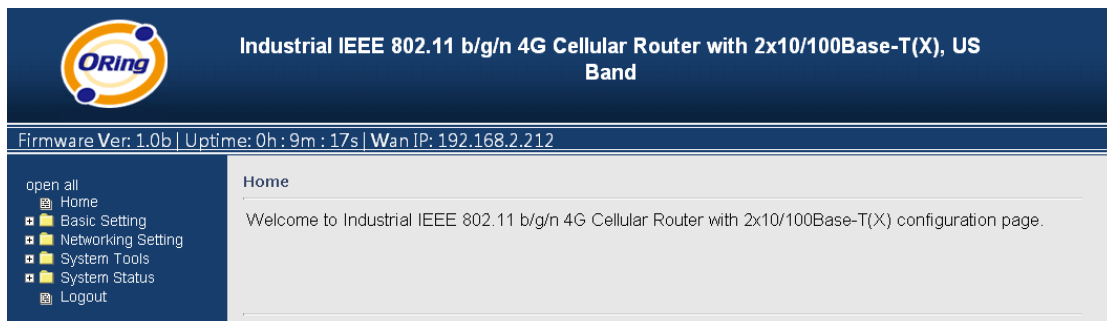

## 5.2 Configuration

On top of the Home screen shows information about the firmware version, uptime, and WAN IP address.

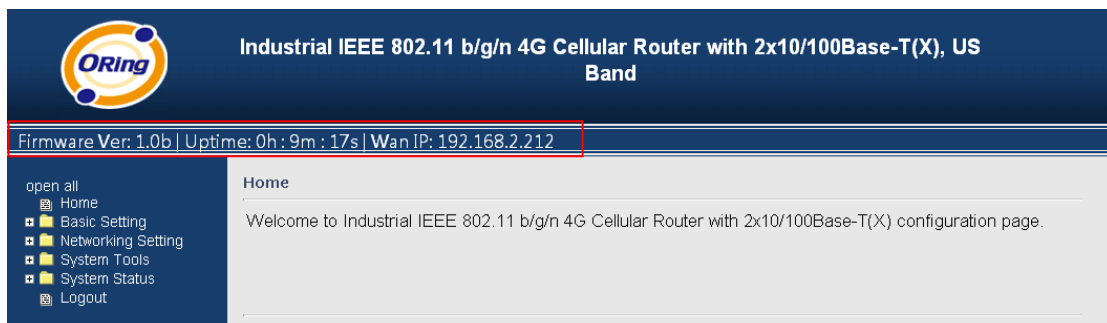

Label	Description
Firmware	Shows the current firmware version
Uptime	Shows the elapsed time since the AP router is started
Wan IP	Shows WAN IP address

### 5.2.1 Basic Setting

This section will guide you through the general settings for the router.

### WAN

This page allows you to configure WAN settings. Different WAN connection types will have different settings.

#### WAN Connection Type as Dynamic/Static IP:

**Basic Setting --> WAN**

WAN settings.

WAN Connection Type: Dynamic/Static IP ▾

**Obtain an IP address automatically**

**Use the following IP address:**

IP Address:

Subnet Mask:

Default Gateway:

**Obtain DNS server address automatically**

**Use the following DNS server addresses:**

Preferred DNS:

Alternate DNS:

**Use Modem/3G/4G as backup connection.**

Phone Number:

APN:

User Name:

Password:

Ping Test Site:

Label	Description
<b>Obtain an IP address automatically</b>	Select this option if you want the IP address of the WAN port to be assigned automatically by the DHCP server in your network.
<b>Use the following IP address</b>	Select this option if you want to assign an IP address to the WAN port manually. You should set IP Address, Subnet Mask, and Default Gateway according to IP rules.
<b>Obtain DNS server address automatically</b>	Obtains a DNS server address from a DHCP server. If you have chosen to obtain an IP address automatically, this option will be selected accordingly.
<b>Use the following DNS server addresses</b>	Specifies a DNS server address manually. You can enter two addresses as the primary and secondary options.
<b>Use Modem/3G as backup connection</b>	<p>Enable this option if you want to use Modem/3G as a backup connection when main connection is lost.</p> <p>Enter your account username and password in the corresponding fields.</p> <p>Type a website address such as <a href="http://www.google.com">www.google.com</a> in Ping Test Site to use it to check if the connection is alive or lost.</p>

### WAN Connection Type as PPPoE:

Basic Setting --> WAN

WAN Settings.

WAN Connection Type:

User Name:

Password:

Service Name:  (optional)

AC Name:  (optional)

**Specify the IP & DNS provided by ISP ( If unknown, leave it unchecked )**

IP Address:

Preferred DNS:

Alternate DNS:

**Connection Mode**

Auto

Connect On Demand  
Max Idle Time:  minutes (0 represents never bring down the link)

Manual

**Use Modem/3G/4G as backup connection.**

Phone Number:

APN:

User Name:

Password:

Ping Test Site:

Link Status: Disconnected

Label	Description
<b>User Name / Password</b>	Enter the username & password provided by your ISP.
<b>AC Name</b>	Enter the name of the access concentrator provided by your ISP
<b>Service Name</b>	Enter the service name provided by your ISP
<b>Specify the IP &amp; DNS provided by ISP</b>	Enter a static IP and DNS address required by other ISPs.
<b>Connection Mode</b>	<p><b>Auto:</b> connect automatically when the router boots up</p> <p><b>Connect on Demand:</b> disconnect the PPP session if the router has had no traffic for a specified amount of time. Fill a number in the Max Idle Time field.</p> <p><b>Manual:</b> connects or disconnects manually via the Connect/Disconnect buttons at the end of the page</p>
<b>Use Modem/3G/4G as backup connection</b>	<p>Enable this option if you want to use modem/3G/4G as a backup connection when main connection is lost.</p> <p>Enter your account username and password in the corresponding fields.</p> <p>Type a website address such as <a href="http://www.google.com">www.google.com</a> in Ping Test Site to use it to check if the connection is alive or lost.</p>

## WAN Connection Type as Modem/3G/4G

**Basic Setting --> WAN**

WAN Settings.

WAN Connection Type: Modem/3G/4G ▼

Phone Number:

APN:

User Name:

Password:

Baud Rate: 460800 ▼

Ping Test Site:

PIN:  Enable PIN check before dialing

PIN Code:

SIM Status: Checking

Auto Connect :  Enable

Reconnect on Failure:  Enable

Fast Mode:  Enable

Two LAN Ports:  Enable

Device Status : 4G modem available.

Operations : Connect Disconnect

Link Status : Disconnected

Modem Status: Operator:  
RadioType:  
Signal Quality:

Label	Description
<b>APN</b>	Enter the APN value (optional)
<b>User Name</b>	Enter the user name provided by your ISP
<b>Password</b>	Enter the password provided by your ISP
<b>Baud Rate</b>	Select a Baud Rate from the drop-down list
<b>Ping Test Site</b>	Type a website address the field to use it to check if the connection is alive or lost.
<b>PIN</b>	Enter a PIN code if you want to perform PIN check
<b>Auto Connect</b>	Check to start connections when the router boots up
<b>Reconnect on Failure</b>	Check to allow for reconnection when links fail
<b>Two LAN Ports</b>	When connecting to a WAN network through wireless

	connections such as a 3G SIM card, you can turn the idling WAN port to act as a LAN port by checking the box.
<b>Device Status</b>	Shows the status of the device
<b>Operations</b>	Click <b>Connect</b> to start modem/3G connections or <b>Disconnect</b> to shut down connections
<b>Link Status</b>	Shows the status of connections
<b>Modem Status</b>	Shows information about the modem

## WAN Connection Type as Wireless Client

**Basic Setting --> WAN**

WAN Settings.

WAN Connection Type:

IP Config Setting.

**Obtain an IP address automatically**

**Use the following IP address:**

IP Address:

Subnet Mask:

Default Gateway:

**Obtain DNS server address automatically**

**Use the following DNS server addresses:**

Preferred DNS:

Alternate DNS:

Wireless Client Setting.

Peer AP SSID:

**Security Options**

Security Type:

**Use Modem/3G/4G as backup connection.**

Phone Number:

APN:

User Name:

Password:

Ping Test IP Address:

Label	Description
<b>Obtain an IP address automatically</b>	Select this option if you want the IP address of the WAN port to be assigned automatically by the DHCP server in your network.
<b>Use the following IP address</b>	Select this option if you want to assign an IP address to the WAN port manually. You should set IP Address, Subnet Mask, and Default Gateway according to IP rules.
<b>Obtain DNS server address automatically</b>	Obtains a DNS server address from a DHCP server. If you have chosen to obtain an IP address automatically, this option will be selected accordingly.
<b>Use the following DNS server addresses</b>	Specifies a DNS server address manually. You can enter two addresses as the primary and secondary options.
<b>Use Modem/3G/4G as backup connection</b>	<p>Enable this option if you want to use Modem/3G/4G as a backup connection when main connection is lost. Enter your account username and password in the corresponding fields.</p> <p>Type a website address such as <a href="http://www.google.com">www.google.com</a> in Ping Test Site to use it to check if the connection is alive or lost.</p>
<b>Peer AP SSID</b>	Enter the SSID of the AP you want to connect as a client
<b>Security Type</b>	<p>You can choose the security type for your WLAN connection from the following options:</p> <p><b>WEP:</b> WEP (Wired Equivalent Privacy) is a wireless security protocol for WLAN. WEP will encrypt data transmitted on the WLAN.</p> <p><b>WPA/WPA2 Personal:</b> uses a pre-shared key for authentication. This pre-shared key is then dynamically sent between the AP and clients. Each authorized computer is given the same pass phrase.</p>

## LAN

This page allows you to configure the IP settings of the LAN for the router. The LAN IP address is private to your internal network and is not visible to Internet.

**Basic Setting --> LAN**

---

LAN Side settings.

Router Name:

IP Address:

Subnet Mask:

LLDP Protocol:  Enable  Disable

---

Label	Description
<b>Router Name</b>	Enter the name of your router
<b>IP Address</b>	The IP address of the LAN. The default value is <b>192.168.10.1</b>
<b>Subnet Mask</b>	The subnet mask of the LAN. The default value is <b>255.255.255.0</b>
<b>LLDP Protocol</b>	LLDP is a vendor-neutral protocol used by network devices for advertising their identity, capabilities, and neighbors on a LAN. You can enable or disable LLDP protocol.

## DHCP

DHCP is a network protocol designed to allow devices connected to a network to communicate with each other using an IP address. The connection works in a client-server model, in which DHCP clients request an IP address from a DHCP server. The router comes with a built-in DHCP (Dynamic Host Control Protocol) server which assigns an IP address to a computer (DHCP client) on the LAN automatically. The router can also serve as a relay agent which will forward DHCP requests from DHCP clients to a DHCP server on the Internet.

The IP allocation provides one-to-one mapping of MAC address to IP address. When a computer with a MAC address requesting an IP address from the router, it will be assigned with the IP address according to the mapping. You can choose one from the client list and add it to the mapping list.



## DHCP Server

Basic Setting --> DHCP -> DHCP Server

Set DHCP Server.

---

DHCP Server:  Enabled  Disabled

Starting IP:

Ending IP:

Lease Time:  Hours

Local Domain Name:  (optional)

DNS Server 1:  (optional)

DNS Server 2:  (optional)

WINS Server:  (optional)

Allocate IP Address Manually.

-- Choose a Client to Edit --

MAC Address	IP Address	Operations
<input type="text"/>	<input type="text"/>	<input type="button" value="Add"/> <input type="button" value="Clear"/>

Static DHCP Client List:

#	MAC Address	IP Address	Operations
<input type="button" value="Delete All"/>			

Label	Description
<b>DHCP Server</b>	Enables or disables the DHCP server function. The default setting is <b>Enabled</b> .
<b>Starting IP</b>	The starting IP address of the IP range assigned by the DHCP server
<b>Ending IP</b>	The ending IP address of the IP range assigned by the DHCP server
<b>Lease Time</b>	The period of time for the IP address to be leased. During the lease time, the DHCP server cannot assign that IP address to any other clients. Enter a number in the field. The default setting is 48 hours.
<b>Local Domain Name</b>	Enter the local domain name of a private network (optional)
<b>DNS Server 1&amp;2</b>	Enter the IP address for the DNS server (optional)
<b>WINS Server</b>	Enter the WINS server (optional)
<b>Allocate IP Address Manually</b>	The IP Allocation section provides one-to-one mapping of MAC address to IP address. When a computer with the MAC address requests an IP from the router, it will be assigned with

	the IP address according to the mapping. You can choose one from the client list and add it to the mapping relationship.
<b>Static DHCP Client List</b>	The list shows the one-to-one relationship of the MAC address and IP address.

### DHCP Client List

This page will show the DHCP client information including the host name, MAC address, IP address, and the expiration date of the address.

Basic Setting --> DHCP -> DHCP Client List

Current DHCP Client Information

#	HostName	Mac	IP	Expires In
1	THEBUGLAI	f0:24:75:d9:51:86	192.168.10.2	2 days, 00:26:49

### Wireless LAN

This page enables you to set up the wireless LAN information of the AP.

Basic Setting --> Wireless LAN --> AP

These are the basic wireless settings for the Storage Router.

Basic wireless settings for the AP.

Wireless:  Enabled  Disabled

SSID:

Channel:  ▼

**Security Options**

Security Type:  ▼

Label	Description
<b>SSID</b>	SSID (Service Set Identifier) is a unique name that identifies a network. All devices on the network must be set with the same SSID in order to communicate with each other. Fill in a new SSID in this field if you do not want to use the default value.
<b>Channel</b>	By selecting Auto, the wireless device will automatically choose the channel with least interference.

<b>Security Options</b>	<p>You can choose the security type for your WLAN connection from the following options:</p> <p><b>None:</b> no encryption</p> <p><b>WEP:</b> WEP (Wired Equivalent Privacy) is a wireless security protocol for WLAN. WEP will encrypt data transmitted on the WLAN.</p> <p><b>WPA/WPA2 Personal:</b> uses a pre-shared key for authentication. This pre-shared key is then dynamically sent between the AP and clients. Each authorized computer is given the same pass phrase.</p> <p><b>WPA/WPA2 Enterprise:</b> this type includes all of the features of WPA/WPA2 Personal plus support for 802.1x RADIUS authentication.</p> <p><b>802.1x:</b> authentication through a RADIUS server</p>
-------------------------	--

RADIUS (Remote Authentication Dial-In User Service) is a widely deployed protocol that enables companies to authenticate and authorize remote users' access to a system or service from a central network server.

When you configure the remote access server for RADIUS authentication, the credentials of the connection request are passed to the RADIUS server for authentication and authorization. If the request is both authenticated and authorized, the RADIUS server sends an accept message back to the remote access server and the connection attempt is accepted. If the request is either not authenticated or not authorized, the RADIUS server sends a reject message back to the remote access server and the connection attempt is rejected.

**The principle of the Radius server is shown in the following pictures:**

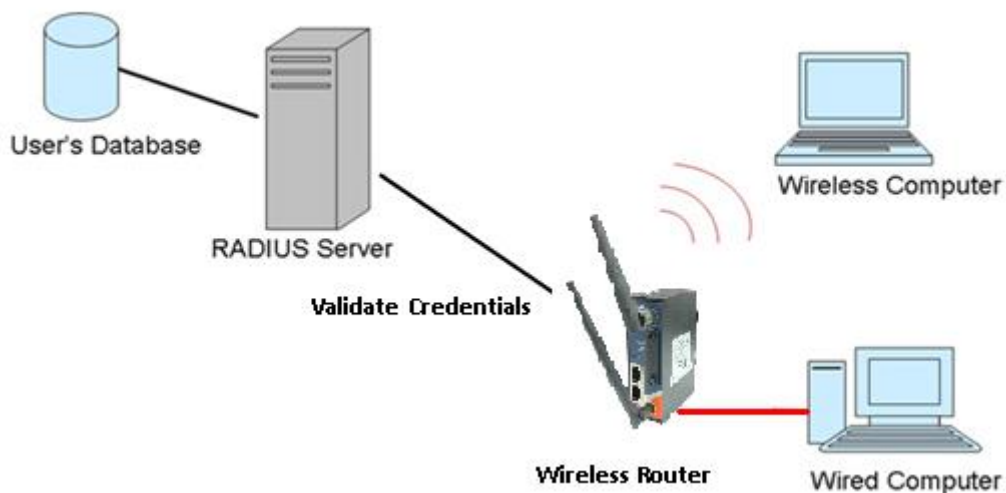

When you set security type as **WEP**, the following fields will appear to allow you to configure individual settings.

**Basic Setting --> Wireless LAN --> AP**

---

These are the basic wireless settings for the Storage Router.

---

Basic wireless settings for the AP.

Wireless:  Enabled  Disabled

SSID:

Channel:

**Security Options**

Security Type:

Auth Mode:  Open  Shared  WEPAUTO

WEP Encryption:

Key Type:

Default Key Index:

KEY1:

KEY2:

KEY3:

KEY4:

Label	Description
<b>Auth Mode</b>	Available values include <b>Open</b> , <b>Shared</b> , and <b>WEPAUTO</b> . When choosing <b>Open</b> or <b>Shared</b> , all of the clients must select the same authentication to associate this AP. If select <b>WEPAUTO</b> , the clients do not have to use the same <b>Open</b> or <b>Shared</b> authentication. They can choose any one to authenticate.
<b>WEP Encryption</b>	You can select <b>64 Bit</b> or <b>128 Bit</b> .
<b>Key Type</b>	Available values include <b>ASCII</b> and <b>Hex Key Type</b> . ASCII (American Standard Code for Information Interchange) is a code for representing English characters as numbers in the range from 0 to 127. Hex digits uses 0–9 to represent values zero to nine, and characters A-F to represent values ten to fifteen.
<b>Default Key Index</b>	Select one of the keys to be the active key
<b>Key 1 to 4</b>	You can input up to four encryption keys.

When you set security type as **WPA/WPA2-Personal**, the following fields will appear to allow you to configure individual settings.

**Basic Setting --> Wireless LAN --> AP**

---

These are the basic wireless settings for the Storage Router.

---

Basic wireless settings for the AP.

Wireless:  Enabled  Disabled

SSID:

Channel:

**Security Options**

Security Type:

Auth Mode:  WPAPSK  WPA2PSK  WPAPSK/WPA2PSK mix

Encryption Type:  TKIP  AES  TKIP/AES mix

Shared Key:  (8~64 characters)

Label	Description
<b>Auth Mode</b>	Available values include <b>WPAPSK</b> , <b>WPA2PSK</b> , and <b>WPAPSK/WPA2PSK mix</b> . WPAPSK and WPA2PSK will encrypt the link without additional RADIUS server, only an access point and client station that supports WPA-PSK is required. For WPA/WPA2, authentication is achieved via WPA RADIUS Server. You need a RADIUS or other authentication server on the network.
<b>Encryption Type</b>	Available values include <b>TKIP</b> , <b>AES</b> , and <b>TKIP/AES mix</b> . WPA-PSK uses TKIP encryption, and WPA2-PSK uses AES encryption. TKIP/AES provides the most reliable security, and is easiest to implement.
<b>Shared Key</b>	Enter a pass phrase in this field. The value must be within 8 to 64 characters

When you set security type as **WPA /WPA2 Enterprise**, the following screen will appear to allow you to configure individual settings.

**Basic Setting --> Wireless LAN --> AP**

---

These are the basic wireless settings for the Storage Router.

---

Basic wireless settings for the AP.

Wireless:  Enabled  Disabled

SSID:

Channel:

**Security Options**

Security Type:

Auth Mode:  WPA  WPA2  WPA/WPA2 mix

Encryption Type:  TKIP  AES  TKIP/AES mix

Radius Server IP:  .  .  .

Radius Port:

Shared Secret:

Label	Description
<b>Auth Mode</b>	Available values include <b>WPAPSK</b> , <b>WPA2PSK</b> , and <b>WPAPSK/WPA2PSK mix</b> . WPAPSK and WPA2PSK will encrypt the link without additional RADIUS server, only an access point and client station that supports WPA-PSK is required. For WPA/WPA2, authentication is achieved via WPA RADIUS Server. You need a RADIUS or other authentication server on the network.
<b>Encryption Type</b>	Available values include <b>TKIP</b> , <b>AES</b> , and <b>TKIP/AES mix</b> . WPA-PSK uses TKIP encryption, and WPA2-PSK uses AES encryption. TKIP/AES provides the most reliable security, and is easiest to implement.
<b>Radius Server IP</b>	Enter the IP address of the RADIUS server
<b>Radius Port</b>	Enter the RADIUS port (default is 1812)
<b>Shared Secret</b>	Enter the RADIUS password or key

When you set security type as **802.1X**, the following fields will appear to allow you to configure individual settings.

**Basic Setting --> Wireless LAN --> AP**

These are the basic wireless settings for the Storage Router.

Basic wireless settings for the AP.

Wireless:  Enabled  Disabled

SSID:

Channel:

**Security Options**

Security Type:

WEP Encryption:

Key Type:

Default Key Index:

KEY1:

KEY2:

KEY3:

KEY4:

Radius Server IP:

Radius Port:

Shared Secret:

Label	Description
<b>WEP Encryption</b>	You can select <b>64 Bit</b> or <b>128 Bit</b> .
<b>Key Type</b>	Available values include <b>ASCII</b> and <b>Hex Key Type</b> . ASCII (American Standard Code for Information Interchange) is a code for representing English characters as numbers in the range from 0 to 127. Hex digits uses 0–9 to represent values zero to nine, and characters A-F to represent values ten to fifteen.
<b>Default Key Index</b>	Select one of the keys to be the active key
<b>Key 1 ~ 4</b>	Input up to four encryption keys
<b>Radius Server IP</b>	Enter the IP address of the RADIUS server
<b>Radius Port</b>	Enter the RADIUS port (default is <b>1812</b> )
<b>Shared Secret</b>	Enter the RADIUS password or key

RADIUS (Remote Authentication Dial-In User Service) is a widely deployed protocol that enables companies to authenticate and authorize remote users' access to a system or service from a central network server.

When you configure the remote access server for RADIUS authentication, the credentials of the connection request are passed to the RADIUS server for authentication and authorization. If the request is both authenticated and authorized, the RADIUS server sends an accept message back to the remote access server and the connection attempt is accepted. If the request is either not authenticated or not authorized, the RADIUS server sends a reject message back to the remote access server and the connection attempt is rejected.

The principle of the Radius server is shown in the following pictures:

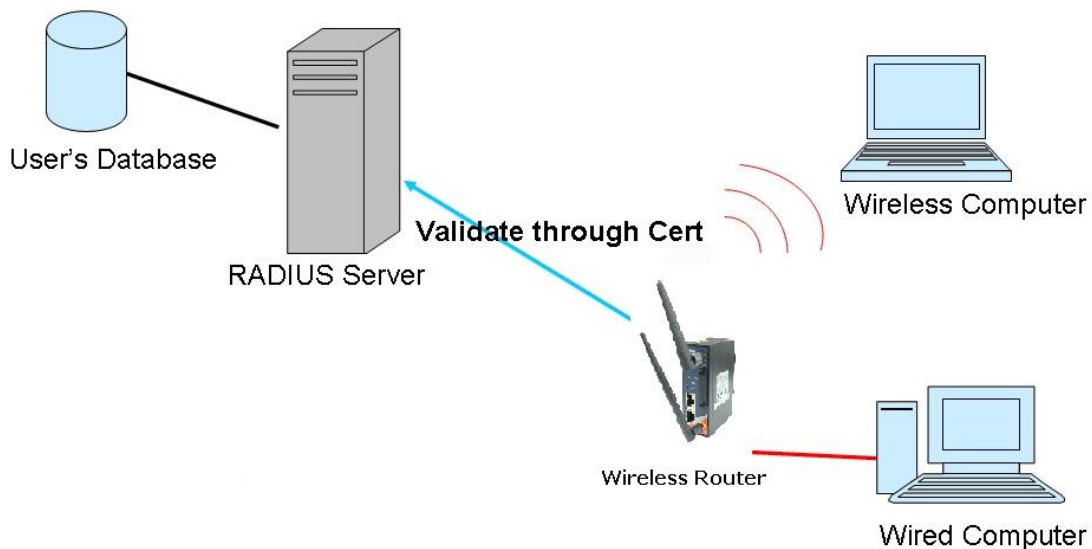

## DDNS

DDNS (Dynamic Domain Name System) allows you to configure a domain name for your IP address which is dynamically assigned by your ISP. Therefore, you can use a static domain name that always points to the current dynamic IP address.

**Basic Setting --> DDNS**

DDNS settings.

DDNS Service:

User Name:  (\*)

Password:  (\*)

Domain:  (\*)

Label	Description
DDNS Service	Choose a DDNS service provider from the list



<b>User Name</b>	Enter the user name of your DDNS account
<b>Password</b>	Enter the password of your DDNS account
<b>Domain</b>	Enter the domain name provided by your dynamic DNS service provider

## Date & Time

In this page, you can set the date & time of the device. A correct date and time will help the system log events. You can set up a NTP (Network Time Protocol) client to synchronize date & time with a NTP server on the Internet.

**Basic Setting --> Date & Time**

Date/Time settings.

System time:            Wed Jul 25 2012 15:8:10

NTP:                       Enable

NTP Server 1:           

Time Zone:               ▼

Synchronise:             ▼ at  ▼ :  ▼

Local Date:               Year  Month  Day

Local Time:               Hour  Minute  Second

Label	Description
<b>NTP</b>	Enables or disables NTP function
<b>NTP Server 1</b>	The primary NTP server
<b>Time Zone</b>	Select the time zone you are located in
<b>Synchronize</b>	Specify the scheduled time for synchronization
<b>Local Date</b>	Set a local date manually
<b>Local Time</b>	Set a local time manually

**5.2.2 Networking Setting**  
**Wireless Setting**  
**Advanced**

NetWorking Setting --> Wireless Setting --> Advanced

Wireless performance tuning.

Beacon Interval:  (msec, range:20~999, default:100)

DTIM Interval:  (range: 1~255, default:1)

Fragmentation Threshold:  (range: 256~2346, default:2346)

RTS Threshold:  (range: 1~2347, default:2347)

Xmit Power:  % (range: 1~100, default:100)

Max Client Threshold:  (range: 1~32, default 10)

Wireless Mode:  BG Mixed Mode  B Mode  G Mode  
 GN mixed Mode  BGN mixed Mode

Preamble:  Long  Short

SSID Broadcast:  Enabled  Disabled

HT Operating Mode:  Mixed Mode  Green Field

HT Band Width:  20 MHz  20/40 MHz

HT Guard Interval:  Long  Short

HT MCS:  ▼

HT RDG:  Disable  Enable

HT Extension Channel:  ▼

HT Aggregation MSDU:  Disable  Enable

HT Auto BlockACK:  Disable  Enable

HT Decline BA Request:  Disable  Enable

Extra parameters for Client Mode:

X-Roaming:  Disabled  Standard

Signal Threshold for Roaming:  dbm(range: 60~90, default 75)

Label	Description
<b>Beacon Interval</b>	A beacon is a packet sent by a wireless access point to synchronize wireless devices. The beacon interval value indicates the frequency interval of the beacon. Increasing the beacon interval reduces the number of beacons and the overhead associated with them. The default value is 100, but 50 is recommended when reception is poor.
<b>DTIM Interval</b>	The default value is 1. This value, between 1 and 255

	<p>milliseconds, indicates the interval of the Delivery Traffic Indication Message (DTIM). A DTIM field is a countdown field informing clients of the next window for listening to broadcast and multicast messages. When the AP has buffered broadcast or multicast messages for associated clients, it sends the next DTIM with a DTIM Interval value. Its clients hear the beacons and awaken to receive the broadcast and multicast messages.</p>
<b>Fragmentation Threshold</b>	<p>The value specifies the maximum size for a packet before data is fragmented into multiple packets. The value should remain at the default <b>2346</b> (the range is 256 - 2346 bytes). If you experience a high packet error rate, you may slightly increase the value. Setting the value too low may result in poor network performance. Only minor modifications of this value are recommended.</p>
<b>RTS Threshold</b>	<p>The RTS (Request to Send) Threshold is the amount of time a wireless device, attempting to send, will wait for a recipient to acknowledge that it is ready. Normally, the AP sends a RTS frame to a station and negotiates the sending of data. After receiving the RTS, the station responds with a CTS (Clear to Send) frame to acknowledge the right to begin transmission. To ensure communication, the maximum value should be used, which is the default value <b>2347</b> (the range is 0-2347 bytes). If a network packet is smaller than the preset RTS threshold size, the RTS/CTS mechanism will not be enabled.</p>
<b>Xmit Power</b>	<p>Xmit Power allows you to change the power output level. This value ranges from 1 - 100 percent, default value is 100 percent. A safe increase of up to 60 percent would be suitable for most users. Higher power settings are not recommended for users due to excess heat generated by the radio chipset, which can affect the life of the AP.</p>
<b>Max Client Threshold</b>	<p>This is the maximum number of clients for an AP. When the number of clients exceeds the value, the AP will reject the roaming connection. This value is only used on AP-mode equipment.</p>
<b>Wireless Network Mode</b>	<p>You can select single or mixed wireless modes. In mixed mode, the device is able to offer various WiFi network types</p>

	(B, G and N) at the same time from a single 2.4GHz radio. 802.11n transmission is always embedded in an 802.11a, for 5GHz radios, or 802.11g for 2.4GHz radio transmissions. This is called Mixed Mode Format protection (also known as L-SIG TXOP Protection).
<b>Preamble</b>	Available values include <b>Long</b> and <b>Short</b> , with <b>Long</b> as the default value. If all clients and access points in your wireless network support short preamble, then enabling it can boost overall throughput. However, if any wireless device does not support short preamble, then it will not be able to communicate with your network. If you are not sure whether your radio supports the short RF preamble, you must disable this feature.
<b>SSID Broadcast</b>	When wireless clients survey the local area for wireless networks to associate with, they will detect the SSID broadcasted by the AP. Click <b>Enable</b> if you want to broadcast the AP SSID, otherwise click <b>Disable</b> to inactivate the function.

### MAC Filter

This page allows you to set up MAC filters to allow or deny wireless clients to connect to the router. You can manually add a MAC address or select a MAC address from the Associated Clients list currently associated with the router.

NetWorking Setting --> Wireless Setting--> MAC Filter

Filters are used to allow or deny Wireless Clients from accessing the AP.

MAC Filters:  Enabled  Disabled

**Options**

Only allow MAC address(es) listed below to connect to AP

Only deny MAC address(es) listed below to connect to AP

Associated Clients:  Copy To

MAC Filter Table:

1.	<input type="text"/>	11.	<input type="text"/>	21.	<input type="text"/>
2.	<input type="text"/>	12.	<input type="text"/>	22.	<input type="text"/>
3.	<input type="text"/>	13.	<input type="text"/>	23.	<input type="text"/>
4.	<input type="text"/>	14.	<input type="text"/>	24.	<input type="text"/>
5.	<input type="text"/>	15.	<input type="text"/>	25.	<input type="text"/>
6.	<input type="text"/>	16.	<input type="text"/>	26.	<input type="text"/>
7.	<input type="text"/>	17.	<input type="text"/>	27.	<input type="text"/>
8.	<input type="text"/>	18.	<input type="text"/>	28.	<input type="text"/>
9.	<input type="text"/>	19.	<input type="text"/>	29.	<input type="text"/>
10.	<input type="text"/>	20.	<input type="text"/>	30.	<input type="text"/>

Label	Description
<b>MAC Filter</b>	Select <b>Enabled</b> or <b>Disabled</b> to activate or deactivate MAC filters
<b>Options</b>	Select one of the options to allow or deny the MAC address in the list
<b>Associated Clients</b>	Shows the wireless MAC addresses associated with the router
<b>MAC Filter Table</b>	You can edit up to MAC addresses in these fields
<b>Apply</b>	Click to activate the configurations

## NAT Setting

### Virtual Server

This page allows you to set up virtual server setting. A virtual server allows Internet users to access services on your LAN. This is a useful function if you host services online such as FTP, Web or game servers. A public port must be defined for the virtual server on your router in order to redirect traffic to an internal LAN IP address and LAN port. Any PC used as a virtual server must have a static or reserved IP address.

Networking Setting --> NAT Setting -> Virtual Server

Virtual server settings.

Virtual Server:  Enable  Disable

Description:

Public IP:  All  Specify

Public Port:

Protocol:  TCP  UDP  Both

Local IP:

Local Port:

Enable Now:  Yes  No

Virtual server list:

#	Description	Public IP	Public Port	Protocol	Local IP	Local Port	Enabled	Ops
---	-------------	-----------	-------------	----------	----------	------------	---------	-----

Label	Description
<b>Virtual Server</b>	Select <b>Enabled</b> or <b>Disabled</b> to activate or deactivate virtual server
<b>Description</b>	Enter the description of the entry. Acceptable characters are 0-9, a-z, and A-Z. A null value is allowed.
<b>Public IP</b>	Enter a public IP allowed to access the virtual service. If not specified, choose <b>All</b> .
<b>Public Port</b>	The port number to be used to access the virtual service on the WAN (Wide Area Network)
<b>Protocol</b>	The protocol used for the virtual service
<b>Local IP</b>	The IP address of the computer that will provide virtual service
<b>Local Port</b>	The port number of the service used by the private IP computer
<b>Enable Now</b>	Enables the virtual server entry after adding it
<b>Virtual server list</b>	Click <b>Edit</b> to edit the virtual service entry and <b>Del</b> to delete the entry.

### DMZ

DMZ (Demilitarized Zone) allows a computer to be exposed to the Internet without passing through the security settings and therefore is unsecured. This feature is useful for special purposes such as gaming.

To use this function, you need to set an internal computer as the DMZ host by entering its IP address. Adding a client to the DMZ may expose your local network to a variety of security

risks, so use this function carefully.

Networking Setting --> NAT Setting -> DMZ

---

DMZ settings.

DMZ:  Enable  Disable

Description:

DMZ Host IP:

Label	Description
<b>DMZ</b>	Enables or disables DMZ
<b>Description</b>	Enter a description for the DMZ host entry
<b>DMZ Host IP</b>	Enter the IP address of the computer to act as the DMZ host

### UPnP

The UPnP (Universal Plug and Play) feature allows Internet devices to access local host resources or devices as needed. UPnP-enabled devices can be automatically discovered by the UPnP service application on the LAN.

Networking Setting --> NAT Setting -> UPnP

---

UPnP settings.

UPnP:  Enabled  Disabled

Enable NAT-PMP

UPnP List:

#	Application	Ext Port	Protocol	Int Port	IP Address
---	-------------	----------	----------	----------	------------

Label	Description
<b>UPnP</b>	Enable or disable UPnP.
<b>Enable NAT-PMP</b>	NAT-PMP allows a computer in a private network (behind a NAT router) to automatically configure the router to allow parties outside the private network to contact with each other. NAT-PMP operates with UDP. It essentially automates the process of port forwarding. Check the box to enable NAT-PMP.
<b>UPnP List</b>	This table lists the current auto port forwarding information. <b>Application:</b> The application that generates this port

	<p>forwarding.</p> <p><b>Ext Port:</b> The port opened on WAN</p> <p><b>Protocol:</b> The protocol type</p> <p><b>Int Port:</b> The port redirected to the local computer</p> <p><b>IP Address:</b> The IP address of local computer to be redirected to</p>
--	--

## Firewall Setting

### IP Filter

IP filters enable you to control the forwarding of incoming and outgoing data between your LAN and the Internet and within your LAN. This control is implemented via IP filter rules which are defined to block attempts by certain computers on your LAN to access certain types of data or Internet locations. You can also block incoming access to computers on your LAN.

Networking Setting --> Firewall Setting -> IP Filter

IP filter settings.

IP Filter:  Enable  Disable

Description:

Rule:

Direction:

IP Address: Source IP:  Destination IP:

Protocol:  All  ICMP  Specify protocol number:

TCP  Specify port:

UDP  Specify port:

Enable Now:  Yes  No

IP filter list:

#	Description	Rule	Direction	Source IP	Destination IP	Protocol	Port	Enabled	Operations
---	-------------	------	-----------	-----------	----------------	----------	------	---------	------------

Label	Description
<b>IP Filter</b>	Enables or disables the IP Filter
<b>Description</b>	Enter description for the entry.
<b>Rule</b>	Configures the rules to be applied to the IP filter. Available options include <b>DROP</b> , <b>ACCEPT</b> , and <b>REJECT</b> .
<b>Direction</b>	Specifies the direction of data flow to be filtered
<b>IP Address</b>	Enter the IP address of the source and destination computer



<b>Protocol</b>	Configures the protocol to be filtered
<b>Enable Now</b>	Click <b>Yes</b> to enable the entry after adding it
<b>IP filter list</b>	Shows the information of all IP filters. Click <b>Edit</b> to edit the entry or <b>Del</b> to delete the entry.

### MAC Filter

This page enables you to deny or allow LAN computers to access the Internet based on their MAC addresses.

Networking Setting --> Firewall Setting -> MAC Filter

MAC Filter settings.

MAC Filter:  Enable  Disable

Description:

Rule:

MAC Address:  (e.x. 00:11:22:aa:bb:cc)

Enable Now:  Yes  No

MAC filter list:

#	Description	Rule	MAC Address	Enabled	Operations
---	-------------	------	-------------	---------	------------

Label	Description
<b>MAC Filter</b>	Enables or disables the MAC Filter
<b>Description</b>	Enter description for the entry
<b>Rule</b>	Configures the rules to be applied to the MAC filter. Available options include <b>DROP</b> , <b>ACCEPT</b> , and <b>REJECT</b> .
<b>MAC Address</b>	Enter the MAC address to be filtered
<b>Enable Now</b>	Click <b>Yes</b> to enable the entry after adding it
<b>MAC filter list</b>	Shows the information of all MAC filters. Click <b>Edit</b> to edit the entry or <b>Del</b> to delete the entry.

### Custom Rules

Custom firewall rules provide more granular access control beyond LAN isolation. You can define a set of firewall rules that is evaluated for every request sent by a wireless user associated to that SSID. Firewall rules are evaluated from top to bottom. The first rule that matches is applied, and subsequent rules are not evaluated. If no rules match, the default rule (allow all traffic) is applied.

Networking Setting --> Firewall Setting -> Custom Rules

Custom firewall rules.

Custom Firewall Rules:  Enable  Disable

Note: Each command line must precede with 'iptables'.

## VPN Setting

### OpenVPN

A VPN is a method of linking two locations as if they are on a local private network to facilitate data transmission and ensure data security. The links between the locations are known as tunnels. VPN can achieve confidentiality, authentication, and integrity of data by utilizing encapsulation protocols, encryption algorithms, and hashing algorithms.

Open VPN enables you to easily set up a virtual private network over an encrypted connection. It is a full-function SSL VPN solution which accommodates a wide range of configurations including remote access, site-to-site VPNs, WiFi security, and enterprise-level remote access with load balancing, failover, and fine-grained access control features.

To set up your router as an Open VPN server, you need to install `openvpn` client software for your Windows-based PC. You can download it from <http://openvpn.net/download.html#stable>. The software version must match the current version of Openvpn used by the router which is version 2.0.9.

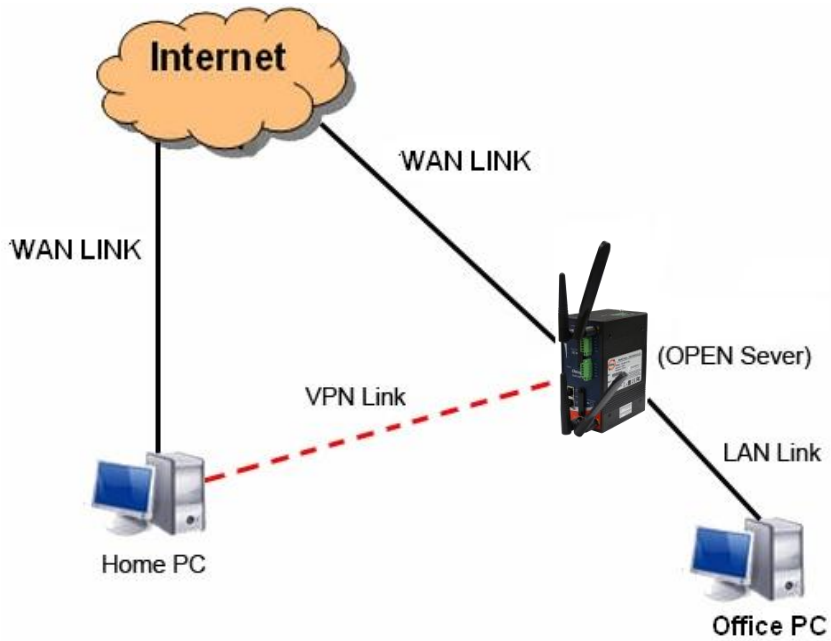

**Connection to Open VPN Server**

When you enable Open VPN Client, you need two routers to create site-to-site VPN connections. The server IP and client IP address should be within the same network domain.

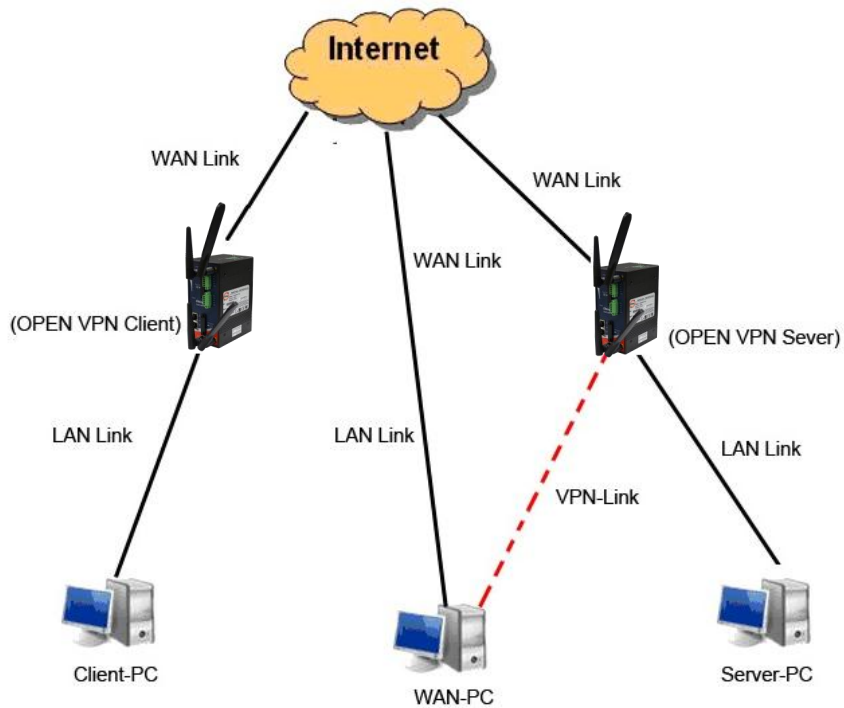

**Open VPN Server and Client Connection**

Networking Setting --> Vpn Setting -> Openvpn

Openvpn settings.

**Server settings.**

Openvpn Server:  Enable  Disable

Tunnel Protocol:

Port:

LZO Compression:  Enable  Disable

Keys Setting:

**Client settings.**

Openvpn Client:  Enable  Disable

Server IP/Host Name:

Tunnel Protocol:

Port:

LZO Compression:  Enable  Disable

Keys Setting:

Label	Description
<b>Openvpn Server</b>	Enables or disables the function of Open VPN server
<b>Tunnel Protocol</b>	Select <b>UDP</b> or <b>TCP</b> protocol depending on your needs. TCP is more reliable than UDP, but UDP performs better than TCP. It is recommended to use UDP if the distance between VPN server and client is short; otherwise, use TCP.
<b>Port</b>	The number of the port (default is <b>1194</b> ).
<b>LZO Compression</b>	Enables or disables the function of LZO Compression
<b>Keys Setting</b>	Select <b>Auto</b> to use preset certificates or <b>Manual</b> to use your certificates. Please install openvpn client software to generate your certificates and paste them here. For more information, please visit openvpn website.
<b>Openvpn Client</b>	Enables or disables the function of Open VPN client.
<b>Server IP/Host Name</b>	Enter the Open VPN server IP address
<b>Tunnel Protocol</b>	Select <b>UDP</b> or <b>TCP</b> protocol depending on your needs. TCP is more reliable than UDP, but UDP performs better than TCP. It is recommended to use UDP if the distance between

	VPN server and client is short; otherwise, use TCP.
<b>Port</b>	The number of the port (default is <b>1194</b> ).
<b>LZO Compression</b>	Enables or disables the LZO Compression
<b>Keys Setting</b>	Select <b>Auto</b> to use preset certificates or <b>Manual</b> to use your certificates. Please install openvpn client software to generate your certificates and paste them here. For more information, please visit openvpn website.

## Routing Protocol

### Routing Setting

This page shows the information of the routing table. You can configure static and dynamic routing settings in this page.

### Static Routing

When RIPv1 & v2 is **Disabled**, the router will operate in static routing mode, which means routers forward packets using either route information from route table entries that you manually configure or the route information that is calculated using dynamic routing algorithms.

Networking Setting --> Routing Protocol -> Routing Setting

Current Routing Table:

Destination	Gateway	Subnet Mask	Metric	Interface
192.168.2.0	0.0.0.0	255.255.255.0	0	eth2.2(WAN)
192.168.10.0	0.0.0.0	255.255.255.0	0	br0(LAN)
default	192.168.2.1	0.0.0.0	0	eth2.2(WAN)

Static Route Entry:

Destination	Gateway	Subnet Mask	Metric	Interface	Operations
<input type="text"/>	<input type="text"/>	<input type="text"/>	<input type="text"/>	WAN ▾	<input type="button" value="Add"/>

Mode:  ▾

RIPv1 & v2:  ▾

Telnet Setting:  Enable  Disable

Port:

Password:

### Dynamic Routing

Dynamic routing lets routing tables in routers change as the routes change. If the best path to a destination cannot be used, dynamic routing protocols change routing tables when necessary to keep your network traffic moving. Dynamic routing protocols include RIP, OSPF, and BGP; however, the device only supports RIP (Routing Information Protocol).

Do not choose **Disable** in the RIPv1 & v2 list if you want to enable Dynamic Routing. After clicking **Apply**, more information will be displayed in Current Routing Table.

Networking Setting --> Routing Protocol -> Routing Setting

Current Routing Table:

Destination	Gateway	Subnet Mask	Metric	Interface
192.168.2.0	0.0.0.0	255.255.255.0	0	eth2.2(WAN)
192.168.10.0	0.0.0.0	255.255.255.0	0	br0(LAN)
default	192.168.2.1	0.0.0.0	0	eth2.2(WAN)

Static Route Entry:

Destination	Gateway	Subnet Mask	Metric	Interface	Operations
				WAN ▼	Add

Mode: Gateway ▼

RIPv1 & v2: Both ▼

Telnet Setting:  Enable  Disable

Port: 23

Password:

Label	Description
<b>Current Routing Table</b>	Shows all routing information, including static and dynamic routing (if enabled)
<b>Static Route Entry</b>	Fills in corresponding information to add new entries to the static routing tablet
<b>Mode</b>	Choose <b>Gateway Mode</b> if you want PCs in the LAN to visit external network, otherwise choose <b>Router Mode</b>
<b>RIPv1 &amp; v2</b>	Choose <b>Disable</b> to disable dynamic routing or other options to configure the interfaces for dynamic routing
<b>Telnet Setting</b>	This option is only available when dynamic routing is enabled. It allows you to make detailed configurations via simple comments. <pre> ca Telnet 192.168.10.1 % Command incomplete.  Hello, this is zebra (version 0.94). Copyright 1996-2002 Kunihiro Ishiguro.  [APR654978&gt; enable      Turn on privileged mode command exit        Exit current mode and down to previous mode list        Print command list ping        send echo messages quit        Exit current mode and down to previous mode show        Show running system information telnet      Open a telnet connection traceroute  Trace route to destination                     </pre>

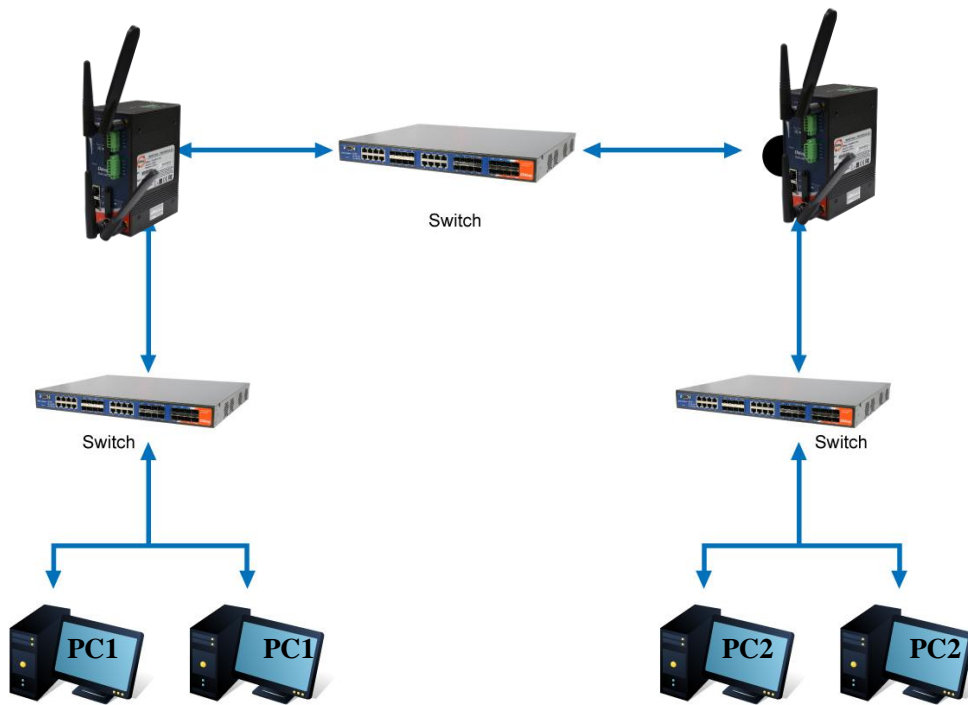

Routing Topography

### 5.2.3 System Tools Login Setting

You can change login name and password in page. The default login name and password are both **admin**.

**System Tools --> Login Setting**

Login settings.

Old Login Name:	admin
Old Password:	<input type="password" value="....."/>
New Login Name:	<input type="text" value="admin"/>
New Password:	<input type="password" value="....."/>
Confirm New Password:	<input type="password" value="....."/>
Web Protocol:	<input checked="" type="radio"/> HTTP <input type="radio"/> HTTPS
Port:	<input type="text" value="80"/>

Label	Description
Old Name	Type in current login name
Old Password	Type in current password
New Name	Enter a new login name. Acceptable characters contain '0-9', 'a-z', 'A-Z' and the length must be 1 to 15 characters. An empty name is not acceptable.
New Password	Enter a new login password. Acceptable characters contain '0-9', 'a-z', 'A-Z' and the length must be 0 to 15 characters.
Confirm New Password	Retype the new password to confirm it.
Web Protocol	Choose a web management page protocol from <b>HTTP</b> and <b>HTTPS</b> . HTTPS (HTTP over SSL) encrypts data sent and received over the Web. Choose HTTPS if you want a secure connection.
Port	Choose a web management page port number. For HTTP, default port is 80. For HTTPS, default port is 443.

## Router Restart

This page allows you to configure restart settings for the router.

Label	Description
Restart Now	Click to restart the router via warm reset
Scheduling	<b>Enable:</b> check to activate the setting Restart at: specify the time for resetting the router. You can configure the action to be performed periodically.

## Firmware Upgrade

ORing launches new firmware constantly to enhance router performance and functions. To upgrade firmware, download new firmware from ORing's website to your PC and install it via



Web upgrade. Make sure the firmware file matches the model of your router. It will take several minutes to upload and update the firmware. After upgrade completes successfully, reboot the router.



During firmware upgrading, do not turn off the power of the router or press the reset button.

## Save/Restore Configurations

This page allows you to save configurations or return settings to previous status. You can download the configuration file from the Web. Note: users using old versions of Internet Explorer may have to click on the warning on top of the browser and choose Download File.

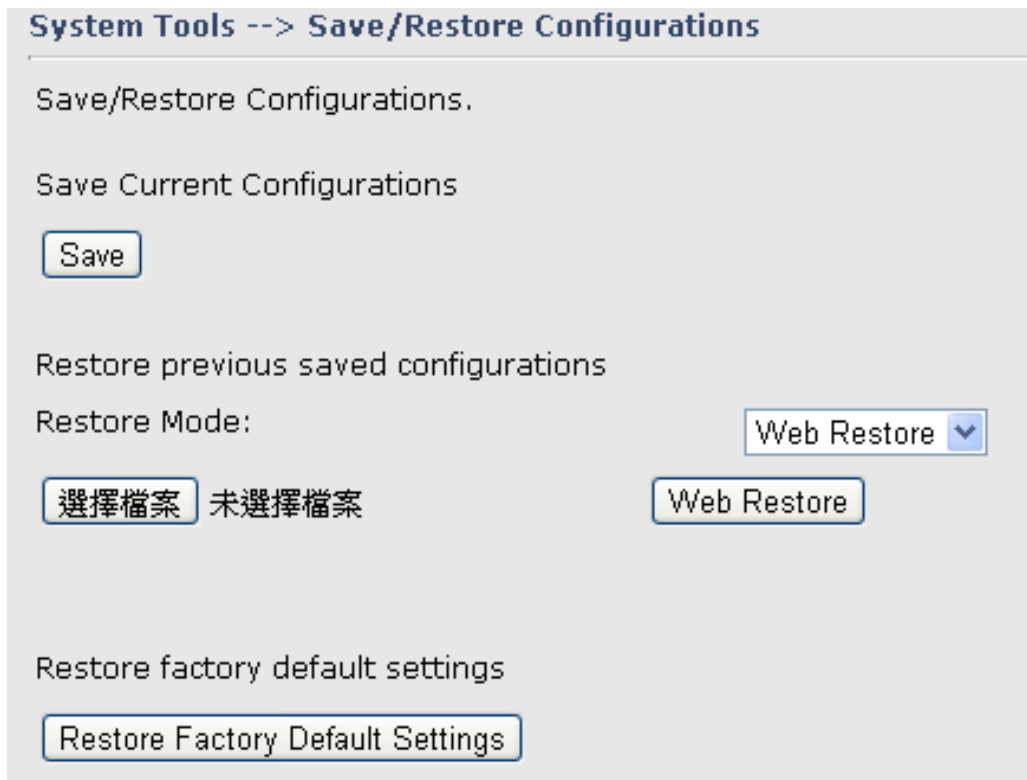

Label	Description
<b>Save</b>	Click to save existing configurations as a file for future usage.
<b>Select File</b>	You can restore configurations to previous status by installing a previous configuration file. To do this, choose <b>Web Restore</b> or <b>Tftp Restore</b> . If you choose <b>Web Restore</b> , you need to choose a file and click <b>Web Restore</b> . If you select <b>Tftp Restore</b> , fill in a Tftp server IP address and the file name before clicking <b>Tftp Restore</b> .
<b>Restore Factory Default Setting</b>	Click to reset the router to the factory settings. The router will reboot to validate the default settings.

## Remote Management

The page allows you to configure remote management settings.

**System Tools --> Remote Management**

Set the Remote Management to access the Router web pages from WAN side.

Remote Management:  Enable  Disable

Management Port:

Permission:  Any Host

Host with IP address:

Host within IP range:  -

Allow Ping from WAN:  Enable  Disable

Label	Description
<b>Remote Management</b>	Enables or disables remote management function
<b>Management Port</b>	Enter the port number that will be open to outside access. This port must be used when you establish a remote connection.
<b>Permission</b>	You can grant remote access to specific users. Tick <b>Any Host</b> or enter a hostname or IP address if you only want a specific computer or device to be able to access the device.
<b>Allow Ping from WAN</b>	Click Enable to allow system administrator to ping the router from WAN interface

## Miscellaneous

This page enables you to run ping test which will send out ping packets to test if a computer is on the Internet or if the WAN connection is OK. Enter a domain name or IP address in the destination box and click **Ping** to test.

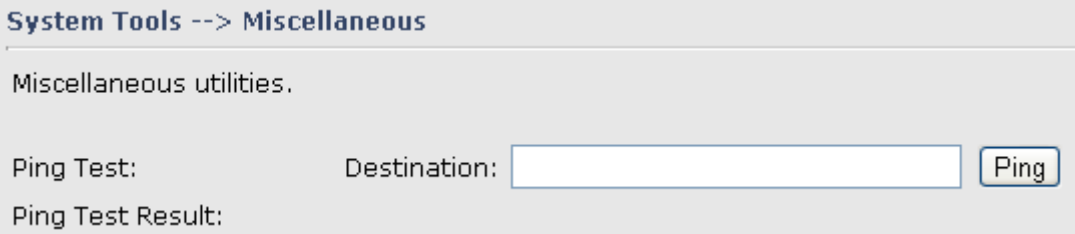

**System Tools --> Miscellaneous**

Miscellaneous utilities.

Ping Test:                      Destination:

Ping Test Result:

## Event Warning Setting

When an error occurs, the device will notify you through system log, and SNMP messages. You can configure the system to issue a notification when specific events occur by checking the box next to the event.

### Syslog Server Settings

**System Tools --> Even Warning Settings --> System Log**

Syslog Server Settings

Syslog Server IP:

Syslog Server Port:  (0 represents default)

Syslog Event Types

Device Event Notification	
Hardware Reset (Cold Start)	<input type="checkbox"/> Syslog
Software Reset (Warm Start)	<input type="checkbox"/> Syslog
Login Failed	<input type="checkbox"/> Syslog
WAN IP Address Changed	<input type="checkbox"/> Syslog
Password Changed	<input type="checkbox"/> Syslog
Eth Link Status Changed	<input type="checkbox"/> Syslog
SNMP Access Failed	<input type="checkbox"/> Syslog
Wireless Client Associated	<input type="checkbox"/> Syslog
Wireless Client Disassociated	<input type="checkbox"/> Syslog
Client Mode Associated	<input type="checkbox"/> Syslog
Client Mode Disassociated	<input type="checkbox"/> Syslog
Client Mode Roaming	<input type="checkbox"/> Syslog
Fault Event Notification	
Eth1 Link Down	<input type="checkbox"/> Syslog
Eth2 Link Down	<input type="checkbox"/> Syslog

Label	Description
<b>Syslog Server IP</b>	Enter the IP address of a remote server if you want the logs to be stored remotely. Leave it blank will disable remote syslog.
<b>Syslog Server Port</b>	Specifies the port to be logged remotely. Default port is 514.

**E-Mail**

**System Tools --> Even Warning Settings --> E-mail**

E-mail Server Settings

SMTP Server:  (optional)

Server Port:  (0 represents default)

E-mail Address 1:

E-mail Address 2:

E-mail Address 3:

E-mail Address 4:

E-mail Event Types

Device Event Notification	
Hardware Reset (Cold Start)	<input type="checkbox"/> SMTP Mail
Software Reset (Warm Start)	<input type="checkbox"/> SMTP Mail
Login Failed	<input type="checkbox"/> SMTP Mail
WAN IP Address Changed	<input type="checkbox"/> SMTP Mail
Password Changed	<input type="checkbox"/> SMTP Mail
Eth Link Status Changed	<input type="checkbox"/> SMTP Mail
SNMP Access Failed	<input type="checkbox"/> SMTP Mail
Wireless Client Associated	<input type="checkbox"/> SMTP Mail
Wireless Client Disassociated	<input type="checkbox"/> SMTP Mail
Client Mode Associated	<input type="checkbox"/> SMTP Mail
Client Mode Disassociated	<input type="checkbox"/> SMTP Mail
Client Mode Roaming	<input type="checkbox"/> SMTP Mail

Fault Event Notification	
Eth1 Link Down	<input type="checkbox"/> SMTP Mail
Eth2 Link Down	<input type="checkbox"/> SMTP Mail

Label	Description
<b>SMTP Server</b>	Enter a backup host to be used when the primary host is unavailable.
<b>Server Port</b>	Specifies the port where MTA can be contacted via SMTP server
<b>E-mail Address 1-4</b>	Enter the mail address that will receive notifications

**SMS**

System Tools --> Even Warning Settings --> SMS Log

SMS Settings

Cell Phone Number:

Send SMS Interval:  (sec.)

SMS Send Event Types

Device Event Notification	
Hardware Reset ( Cold Start)	<input type="checkbox"/> SMS Trap
Software Reset ( Warm Start)	<input type="checkbox"/> SMS Trap
Login Failed	<input type="checkbox"/> SMS Trap
WAN IP Address Changed	<input type="checkbox"/> SMS Trap
Password Changed	<input type="checkbox"/> SMS Trap
Eth Link Status Changed	<input type="checkbox"/> SMS Trap
SNMP Access Failed	<input type="checkbox"/> SMS Trap
Wireless Client Associated	<input type="checkbox"/> SMS Trap
Wireless Client Disassociated	<input type="checkbox"/> SMS Trap
Client Mode Associated	<input type="checkbox"/> SMS Trap
Client Mode Disassociated	<input type="checkbox"/> SMS Trap
Client Mode Roaming	<input type="checkbox"/> SMS Trap

Fault Event Notification	
Eth1 Link Down	<input type="checkbox"/> SMS Trap
Eth2 Link Down	<input type="checkbox"/> SMS Trap

Label	Description
Cell Phone Number	Set Cell Phone Number.
Send SMS Interval	Set send interval

## SNMP Settings

**System Tools --> Even Warning Settings --> SNMP Settings**

SNMP Settings

SNMP Agent:  Enable  Disable

SNMP Trap Server 1:

SNMP Trap Server 2:

SNMP Trap Server 3:

SNMP Trap Server 4:

Community:

SysLocation:

SysContact:

SNMP Event Types

Device Event Notification	
Hardware Reset (Cold Start)	<input type="checkbox"/> SNMP Trap
Software Reset (Warm Start)	<input type="checkbox"/> SNMP Trap
Login Failed	<input type="checkbox"/> SNMP Trap
WAN IP Address Changed	<input type="checkbox"/> SNMP Trap
Password Changed	<input type="checkbox"/> SNMP Trap
Eth Link Status Changed	<input type="checkbox"/> SNMP Trap
SNMP Access Failed	<input type="checkbox"/> SNMP Trap
Wireless Client Associated	<input type="checkbox"/> SNMP Trap
Wireless Client Disassociated	<input type="checkbox"/> SNMP Trap
Client Mode Associated	<input type="checkbox"/> SNMP Trap
Client Mode Disassociated	<input type="checkbox"/> SNMP Trap
Client Mode Roaming	<input type="checkbox"/> SNMP Trap

Fault Event Notification	
Eth1 Link Down	<input type="checkbox"/> SNMP Trap
Eth2 Link Down	<input type="checkbox"/> SNMP Trap

Label	Description
<b>SNMP Agent</b>	SNMP (Simple Network Management Protocol) Agent is a service program that runs on the access point. The agent provides management information to the NMS by keeping track of various operational aspects of the AP system. You can enable or disable the function.

<b>SNMP Trap Server</b> 1-4	Enter the IP address of the SNMP server which will send out traps generated by the AP.
<b>Community</b>	Community is a password to establish trust between managers and agents. Normally, <b>public</b> is used for read-write community.
<b>SysLocation</b>	Specifies sysLocation string
<b>SysContact</b>	Specifies sysContact string

## 5.2.4 System Status

### System Info

This page displays the detailed information of the router including model name, description, firmware version, WAN, LAN and wireless settings.

**System Status --> System Info**

---

System Info.

<b>Model:</b>	IAR-142-4G	
<b>Model Description:</b>	Industrial IEEE 802.11 b/g/n 4G Cellular Router with 2x10/100Base-T(X)	
<b>WAN:</b>	Mode	Dynamic Setting
	IP Address	192.168.2.212
	Broadcast Address	192.168.2.255
	Subnet Mask	255.255.255.0
	Default Gateway	192.168.2.1
	DNS(Primary)	192.168.2.6
	DNS(Secondary)	168.95.192.1
	MTU	1500
	MAC Address	00:1e:94:02:00:00
<b>LAN:</b>	IP Address	192.168.10.1
	Subnet Mask	255.255.255.0
	MTU	1500
	MAC Address	00:1e:94:01:ff:ff
	DHCP Server	Enabled
<b>Wireless:</b>	Wireless	Enabled
	SSID	oring7620
	Channel	1
	Encryption Mode	WPAPSK/WPA2PSK

### System Log

By checking in a specific box, the router will constantly log the events and provide the files for you to review. You can click **Refresh** to renew the page or **Clear Logs** to clear all or certain log entries.



**System Status --> System Log**

System log.

Log Option:

DHCP Server       Boot Message  
 NTP Client         PPTP VPN  
 System Event       UPNP  
 Firewall             Modem  
 PPPoE Client       OpenVpn

System Log:

#	Date Time	Item	Content
---	-----------	------	---------

### Traffic Statistics

This page displays network traffic statistics for packets both received and transmitted through Ethernet ports and wireless connections.

**System Status --> Traffic Statistics**

Traffic statistics.

Interface	Send	Receive
Wired LAN	83087 Bytes (481 Packets)	208989 Bytes (2368 Packets)
Wired WAN	1184365 Bytes (3204 Packets)	2175606 Bytes (22104 Packets)
Wireless LAN	1840 Bytes (10 Packets)	118657 Bytes (661 Packets)
Wireless WAN	0 Bytes (0 Packets)	0 Bytes (0 Packets)

### Wireless Link List

This page displays the information of the wireless clients connected to the device, including their MAC address, data rate, and link types.

**System Status --> Wireless Link List**

List of connected wireless clients.

Mac Address
00:1e:94:01:c5:d1

# Technical Specifications

ORing AP Router Model	IAR-142-4G	IAR-142+4G
<b>Physical Ports</b>		
10/100 Base-T(X) Ports in RJ45 Auto MDI/MDIX	<b>2</b>	
PoE P.D. port		Present at ETH1 Fully compliant with IEEE 802.3af Power Device specification Over load & short circuit protection Isolation Voltage: 1000 VDC min. Isolation Resistance : 10 <sup>8</sup> ohms min
Sim Card Slot	<b>1</b>	
<b>Cellular Interface</b>		
Antenna Connector	2 x SMA Female	
Cellular Standard	GSM / GPRS/ EGPRS/ EDGE / WCDMA / HSDPA / HSUPA /LTE	
Band Option	<p><b>America(US grade)</b></p> <p>LTE: 1900(B2)/1700(B4)/850(B5)/700(B13)/700(B17)/1900(B25) MHz</p> <p>CDMA/EVDO rev. a/b: 800/1900</p> <p>UMTS/HSDPA/HSUPA/HSPA+/DC-HSPA+: 850/900/1700/1900/2100 MHz</p> <p>GSM/GPRS/EDGE: 850/900/1800/1900 MHz</p> <p><b>Europe(EU grade)</b></p> <p>LTE: 2100(B1)/1800(B3)/2600(B7)/900(B8)/800(B20) MHz</p> <p>UMTS/HSDPA/HSUPA/HSPA+/DC-HSPA+: 800/850/900/1900/2100 MHz</p> <p>GSM/GPRS/EDGE: 850/900/1800/1900 MHz</p>	
<b>WLAN interface</b>		
Antenna Connector	1 x Reverse SMA Female	
Modulation	IEEE802.11b: CCK/DQPSK/DBPSK IEEE802.11g: OFDM IEEE802.11n: BPSK, QPSK, 16-QAM, 64-QAM	
Frequency Band	America / FCC: 2.412~2.462 GHz ( 11 channels ) Europe CE / ETSI: 2.412~2.472 GHz ( 13 channels )	
Transmission Rate	802.11b: 1/2/5.5/11 Mbps 802.11g: 6/9/12/18/24/36/48/54 Mbps 802.11n(40MHz): UP to 150 Mbps	
Transmit Power	802.11b: 13.5dBm ±1.5dBm 802.11g: 13.5dBm ±1.5dBm	

	802.11n(2.4G@20MHz): 13.5dBm ±1.5dBm 802.11n(2.4G@40MHz): 13.5dBm ±1.5dBm
Receiver Sensitivity	802.11b: -90dBm ±2dBm@1Mbps 802.11g: -72dBm ±2dBm@54Mbps 802.11n(2.4G@40MHz,MCS7): -68dBm ±2dBm
Encryption Security	WEP: (64-bit ,128-bit key supported) WPA/WPA2 :802.11i(WEP and AES encryption) WPA-PSK (256-bit key pre-shared key supported) 802.1X Authentication supported TKIP encryption
Wireless Security	SSID broadcast disable
<b>LED indicators</b>	
Power indicator	3 x LEDs, PWR1(2)(PoE) / Ready: Green On: Power is on and functioning Normally.
10/100T RJ45 port indicator	2 x LEDs, Green for port Link/Act at 100Mbps.
WLAN LEDs	1 x LED, Green blinking: WLAN Link /ACT
WAN LEDs	1 x LED, Green blinking : Power is on and functioning Normal
<b>Power</b>	
Redundant Input power	Dual DC inputs. 12-48VDC on 4-pin terminal block
Power consumption	3watts
Overload current protection	Present
Reverse polarity protection	Present
<b>Physical Characteristic</b>	
Enclosure	IP-30
Dimension (W x D x H)	45(W)x80.6(D)x95(H) mm
Weight (g)	360g
	365g
<b>Environmental</b>	
Storage Temperature	-40 to 85oC (-40 to 185°F)
Operating Temperature	-10 to 60°C (14 to 140°F)
Operating Humidity	5% to 95% Non-condensing
<b>Regulatory approvals</b>	
EMI	FCC Part 15, CISPR (EN55022) class A
EMS	EN61000-4-2 (ESD), EN61000-4-3 (RS), EN61000-4-4 (EFT), EN61000-4-5 (Surge), EN61000-4-6 (CS), EN61000-4-8, EN61000-4-11
Shock	IEC60068-2-27
Free Fall	IEC60068-2-31
Vibration	IEC60068-2-6
Safety	EN60950-1
<b>Warranty</b>	3 years

## Compliance

### FCC Statement

This device complies with Part 15 of the FCC Rules. Operation is subject to the following two conditions:

(1) this device may not cause harmful interference and (2) this device must accept any interference received, including interference that may cause undesired operation.

**RF exposure warning:** The equipment complies with RF exposure limits set forth for an uncontrolled environment. The antenna(s) used for this transmitter must not be co-located or operating in conjunction with any other antenna or transmitter.

You are cautioned that changes or modifications not expressly approved by the party responsible for compliance could void your authority to operate the equipment. This device should be operated with minimum distance 20cm between the device and all persons. Operations in the 5.15-5.25GHz band are restricted to indoor usage only.

### Industry Canada Statement

This device complies with Industry Canada licence-exempt RSS standard(s). Operation is subject to the following two conditions: (1) this device may not cause interference, and (2) this device must accept any interference, including interference that may cause undesired operation of the device.

*Le présent appareil est conforme aux CNR d'Industrie Canada applicables aux appareils radio exempts de licence. L'exploitation est autorisée aux deux conditions suivantes : (1) l'appareil ne doit pas produire de brouillage, et (2) l'utilisateur de l'appareil doit accepter tout brouillage radioélectrique subi, même si le brouillage est susceptible d'en compromettre le fonctionnement.*

**Industry Canada - Class B** This digital apparatus does not exceed the Class B limits for radio noise emissions from digital apparatus as set out in the interference-causing equipment standard entitled "Digital Apparatus," ICES-003 of Industry Canada.

*Cet appareil numérique respecte les limites de bruits radioélectriques applicables aux appareils numériques de Classe B prescrites dans la norme sur le matériel brouilleur: "Appareils Numériques," NMB-003 édictée par l'Industrie.*

Operation is subject to the following two conditions: (1) this device may not cause interference,  
and (2) this device must accept any interference, including interference that may cause undesired operation of the device.

*L'opération est soumise aux deux conditions suivantes: (1) cet appareil ne peut causer d'interférences, et (2) cet appareil doit accepter toute interférence, y compris celles susceptibles de provoquer fonctionnement du dispositif.*

To reduce potential radio interference to other users, the antenna type and its gain should be so chosen that the equivalent isotropically radiated power (e.i.r.p.) is not more than that permitted for successful communication.

*Afin de réduire les interférences radio potentielles pour les autres utilisateurs, le type d'antenne et son gain doivent être choisis que la puissance isotrope rayonnée équivalente (PIRE) est pas plus que celle permise pour une communication réussie*

RF exposure warning: The equipment complies with RF exposure limits set forth for an uncontrolled environment. The antenna(s) used for this transmitter must not be co-located or operating in conjunction with any other antenna or transmitter.

*Avertissement d'exposition RF: L'équipement est conforme aux limites d'exposition aux RF établies pour un incontrôlé environnement. L'antenne (s) utilisée pour ce transmetteur ne doit pas être co-localisés ou fonctionner en conjonction avec toute autre antenne ou transmetteur.*