

User Guide
6641-22305

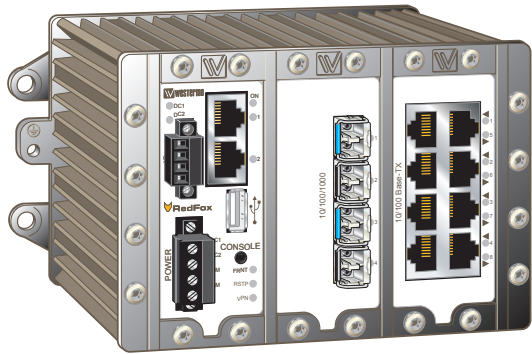

RedFox

S E R I E S



Industrial Routing Switch



www.westermo.com

License Information

This device contains public available software which is under the GPL license. For more information see [legal.pdf](#) included with all firmware releases.

This product includes software developed by the OpenSSL Project for use in the OpenSSL Toolkit. <http://www.openssl.org>

Legal information

The contents of this document are provided "as is". Except as required by applicable law, no warranties of any kind, either express or implied, including, but not limited to, the implied warranties of merchantability and fitness for a particular purpose, are made in relation to the accuracy and reliability or contents of this document. Westermo reserves the right to revise this document or withdraw it at any time without prior notice.

Under no circumstances shall Westermo be responsible for any loss of data or income or any special, incidental, and consequential or indirect damages howsoever caused.

More information about Westermo can be found at the following Internet address:

<http://www.westermo.com>

Safety



Before installation:

Read this manual completely and gather all information on the unit. Make sure that you understand it fully. Check that your application does not exceed the safe operating specifications for this unit.

This unit should only be installed by qualified personnel.

This unit should be built-in to an apparatus cabinet, or similar, where access is restricted to service personnel only.

The power supply wiring must be sufficiently fused, and if necessary it must be possible to disconnect manually from the power supply. Ensure compliance to national installation regulations.

This unit uses convection cooling. To avoid obstructing the airflow around the unit, follow the spacing recommendations (see Cooling section).

Before powering-up, a protective earthing conductor must be connected to the protective earthing terminal and have a cross-sectional area of at least 1.5 mm².



Before mounting, using or removing this unit:

Prevent access to hazardous voltage by disconnecting the unit from power supply.

Warning! Do not open connected unit. Hazardous voltage may occur within this unit when connected to power supply.



Class 1 Laser Product

Do not look directly into fibre optical fibre port or any connected fibre although this unit is designed to meet the Class 1 Laser regulations.

Care recommendations

Follow the care recommendations below to maintain full operation of unit and to fulfil the warranty obligations.

This unit must not be operating with removed covers or lids.

Do not attempt to disassemble the unit. There are no user serviceable parts inside.

Do not drop, knock or shake the unit, rough handling above the specification may cause damage to internal circuit boards.

Do not use harsh chemicals, cleaning solvents or strong detergents to clean the unit.

Do not paint the unit. Paint can clog the unit and prevent proper operation.

Do not expose the unit to any kind of liquids (rain, beverages, etc). The unit is not water-proof. Keep the unit within the specified humidity levels.

Do not use or store the unit in dusty, dirty areas, connectors as well as other mechanical part may be damaged.

If the unit is not working properly, contact the place of purchase, nearest Westermo distributor office or Westermo Tech support.

Fibre connectors are supplied with plugs to avoid contamination inside the optical port.

As soon as no optical fibre is mounted on the connector, e.g. for storage, service or transportation, the plug should be applied.

Warning:

When this unit is operated at an ambient temperature above 53°C (127.4°F), the External Surface of Equipment may exceed Touch Temperature Limit according to EN/IEC/UL 60950-1.

To reduce the risk of fire, use on No. 26 AWG or larger telecommunication line cord.

Note. Fibre Optic Handling

Fibre optic equipment needs special treatment. It is very sensitive to dust and dirt. If the fibre will be disconnected from the unit the protective hood on the transmitter/receiver must be connected. The protective hood must be kept on during transportation. The fibre optic cable must also be handle the same way. If these recommendations are not followed the warranty might be jeopardized.

Cleaning of the optical connectors

In the event of contamination, the optical connectors should only be cleaned by the use of recommended cleaning fluids and correct cleaning equipment.

Recommended cleaning fluids:

- Methyl-, ethyl-, isopropyl- or isobutyl-alcohol
- Hexane
- Naphtha

Maintenance

No maintenance is required, as long as the unit is used as intended within the specified conditions.

Agency approvals and standards compliance

Westermo article number	Denomination	Approval / compliance			
		EMC	SAFETY	EX	MARINE
3641-3110	RFI-10	⌘	⌘	⌘	⌘
3641-3100	RFI-18	⌘	⌘	⌘	⌘
3641-3200	RFI-14-F4G	⌘	⌘	⌘	⌘
3641-3210	RFI-6-F4G	⌘	⌘	⌘	⌘
3641-3300	RFI-18-F4G-T4G	⌘	⌘	⌘	⌘
3641-3310	RFI-10-F4G-T4G	⌘	⌘	⌘	⌘
3641-3420	RFI-18-F16	⌘			⌘
3641-3410	RFI-10-F8	⌘			⌘
3641-3400	RFI-18-F8	⌘			⌘
3641-3320	RFI-18-F4G-T4G-F8	⌘			⌘
3641-3220	RFI-14-F4G-F8	⌘			⌘
EMC	EN 55024, Information technology equipment – Immunity characteristics Limits and methods of measurement				
	EN 55022, Information technology equipment – Radio disturbance characteristics – Limits and methods of measurement				
	EN 61000-6-2, Electromagnetic compatibility – Immunity for industrial environments				
	EN 61000-6-4, Electromagnetic compatibility – Emission for industrial environments				
	EN 50121-4, Railway applications – Electromagnetic compatibility – Emission and immunity of the signalling and telecommunications apparatus"				
	FCC Part 15 Class A				
SAFETY	UL/IEC/EN 60950-1, IT equipment				
EX	EN 60079-0, EN 60079-15 and EN 60079-31				
MARINE	DNV – Standard for Certification No. 2.4, April 2006				

FCC Part 15.105

Notice:

This equipment has been tested and found to comply with the limits for a Class A digital device, pursuant to Part 15 of the FCC Rules. These limits are designed to provide reasonable protection against harmful interference when the equipment is operated in a commercial environment. This equipment generates, uses, and can radiate radio frequency energy and, if not installed and used in accordance with the instruction manual, may cause harmful interference to radio communications. Operation of this equipment in a residential area is likely to cause harmful interference in which case the user will be required to correct the interference at his own expense.

EN 55022

Notice:

This is a class A product. In a domestic environment this product may cause radio interference in which case the user may be required to take adequate measures.

Corrosive environment

Notice:

This product has been successfully tested in a corrosion test according to IEC 60068-2-60, method 3. This means that the product meets the requirements to be placed in an environment classified as ISA-S71.04 class G3.

Note! If the product is placed in a corrosive environment, it is important that all un-used connector sockets are protected with a suitable plug in order to avoid corrosion attacks on the gold plated pins in connectors.



ATEX Information

General

This unit is intended for use in zone 2 and zone 22 hazardous location only.

Marking

 II 3 GD

Ex nA IIC T4 Gc

Ex tc IIIC Dc

SPECIAL CONDITION

WARNING – DO NOT SEPARATE WHEN ENERGIZED

	Indicate that this unit complies with relevant European standards that are harmonized with the 94/9/EC Directive (ATEX).
II	Equipment group II. This unit can be installed in all places with an explosive gas or dust atmosphere other than mines susceptible to firedamp
3	Equipment category 3. A category is the classification according to the required level of protection. This unit ensures the requisite level of protection during normal operation and is intended for use in areas in which explosive atmosphere caused by gases, vapours, mists, or dust mixtures are unlikely to occur or, if they do occur, are likely to do so only infrequently and for a short period only.
GD	Indicates protection concerning explosive atmospheres caused by gases, vapours or mists (G) and dust mixtures (D).
Ex	Indicates that this unit is in conformity with relevant European Ex standard(s).
nA	Type of protection used. This unit is a non-sparking device "nA" which is constructed to minimize the risk of occurrence of arcs or sparks capable of creating an ignition hazard during conditions of normal operation.
IIC	Gas group, a typical gas is hydrogen
T4	Temperature class T4 (T4 = 135°C) This unit is classified in accordance with its maximum surface temperature (external and internal).
Gc	Equipment protection level Gc (EPL Gc). Equipment for explosive gas atmospheres, having a "enhanced" level of protection, which is not a source of ignition in normal operation and which may have some additional protection to ensure that it remains inactive as an ignition source in the case of regular expected occurrences. EPL Gc are analogous to the ATEX Categories (Category 3 G = EPL Gc).
tc	Dust protection provided by external enclosure.
IIIC	Dust group, conductive dust.

Dc	Equipment protection level Dc (EPL Dc). Equipment for explosive dust atmospheres, having a "enhanced" level of protection, which is not a source of ignition in normal operation and which may have some additional protection to ensure that it remains inactive as an ignition source in the case of regular expected occurrences. EPL Dc are analogous to the ATEX Categories (Category 3 D = EPL Dc).
SPECIAL CONDITION	This unit has a special condition of use. The special condition for use contains safety related information that is necessary for the correct installation and safe use.

Ratings

Power	(20 – 48) V DC; 1200 mA
Ambient temperature	$-40^{\circ}\text{C} \leq T_{\text{amb}} \leq +70^{\circ}\text{F}$ ($-40^{\circ}\text{F} \leq T_{\text{amb}} \leq 158^{\circ}\text{F}$)
Ingress protection (IP)	IP40
Maximum surface temperatur	135°C (275°F) (temperature class T4)

Safety control drawing

Position	Direction* / description	Input / Output values
1	IO / Relay output +	$U_{in} = 60 \text{ VDC max}$
2	IO / Relay output -	$I_{in} = 80 \text{ mA max}$
3	IO / Digital in +	$U_{in} = 60 \text{ VDC max}$
4	IO / Digital in -	$I_{in} = 10 \text{ mA max}$

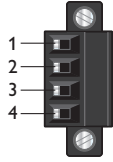

M5 threaded hole for PE connection

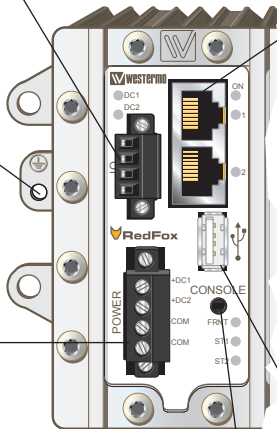

Position	Direction* / description	Input/output values
1	In/out / TD+	Per port: $U = \pm 1 \text{ V}$ (4 μ V/s) $I = \pm 20 \text{ mA}$ Data rate: 10/100 Mbit/s
2	In/out / TD-	
3	In/out / RD+	
4	Not connected	
5	Not connected	
6	In/out / RD-	
7	Not connected	
8	Not connected	
Shield	PE	

Galvanically isolated via signal transformers and capacitively isolated to GND/PE through a 2kV 1000pF capacitor.
See user manual for proven transient protection.

Position	Direction* / description	Input values
1	In / +DC1	$U_{in} = (16 - 60) \text{ VDC}$ $I_{in} = 1.5 \text{ A @ } 16 \text{ VDC}$ $P_{in} = 24 \text{ W @ } 16 \text{ VDC}$
2	In / +DC2	
3	In / COM	
4	In / COM	

Position	Direction* / description	Output values
1	Out / VBUS	$U_{out} = 5 \text{ VDC max}$ $I_{out} = 500 \text{ mA max}$
2	In/out / D-	
3	In/out / D+	
4	GND	
Shield	PE	

Position	Direction* / description	Input/output values
1	In/out / GND	$U = 3.3 \text{ VDC max}$ $I = 24 \text{ mA max}$
2	Out / Tx	
3	In / Rx	

Degree of protection:	IP 40
Ambient temperature:	-40°C to +70°C (-40°F to +158°F). (RFI-10-F4G-T4G and RFI-18-F4G-T4G requires forced air flow at operating temperatures above 60°C 140°F)
Installation spacing:	Minimum 25 mm above/below Minimum 10 mm left/right

* Direction relative this unit!

Safety control drawing

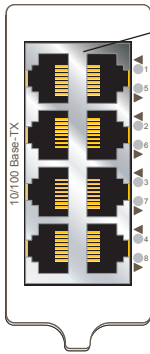

Position	Direction* / description	Input/output values
1	In/out / TD+	Per port: U = ± 1 V (4μV/s) I = ± 20 mA Data rate: 10/100 Mbit/s
2	In/out / TD-	
3	In/out / RD+	
4	Not connected	
5	Not connected	
6	In/out / RD-	
7	Not connected	
8	Not connected	
Shield	PE	

Galvanically isolated via signal transformers and capacitively isolated to GND/PE through a 2kV 1000pF capacitor. See user manual for proven transient protection.

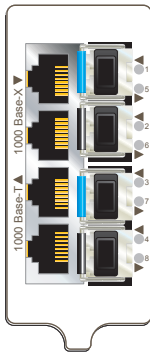

Position	Direction* / description	Input/output values
Rx	In / Receive port	Max 5 dBm
Tx	Out / Transmit port	

Position	Direction* / description	Input/output values
1	In/out / BI_DA+	Per port: U = ± 1 V (4μV/s) I = ± 20 mA Data rate: 100/1000 Mbit/s
2	In/out / BI_DA-	
3	In/out / BI_DB+	
4	In/out / BI_DC+	
5	In/out / BI_DC-	
6	In/out / BI_DB-	
7	In/out / BI_DD+	
8	In/out / BI_DD-	
Shield	PE	

Galvanically isolated via signal transformers and capacitively isolated to GND/PE through a 2kV 1000pF capacitor. See user manual for proven transient protection.

* Direction relative this unit!

Special condition for safe use

Ambient temperature:

This unit is designed for use in extreme ambient temperature conditions as follows:

$-40^{\circ}\text{C} \leq T_{\text{amb}} \leq +70^{\circ}\text{C}$ ($-40^{\circ}\text{F} \leq T_{\text{amb}} \leq 158^{\circ}\text{F}$)

RFI-10-F4G-T4G and RFI-18-F4G-T4G requires forced air flow at operating temperatures above $+60^{\circ}\text{C}$.

Installation in an apparatus cabinet:

This unit requires installation in an apparatus cabinet which holds a degree of protection of at least IP54 and either complies with EN 60079-0 and EN 60079-15 or is an Ex e-, Ex d-, Ex p-, Ex o- or Ex q certified apparatus cabinet.

Resistance to impact:

This unit requires installation in an apparatus cabinet where adequate resistance to impact is provided by the apparatus cabinet. See "Installation in an apparatus cabinet" above for requirements on the external apparatus cabinet.

Resistance to light:

This unit requires installation in an apparatus cabinet where it is protected from light (for example daylight or light from luminaires). See "Installation in an apparatus cabinet" above for requirements on the external apparatus cabinet.

Installation in dust environment:

The amount of dust or dust layer and its influence on the internal ambient temperature in the apparatus cabinet must be taken into account towards the ambient temperature limits of this unit.

Secureness of plugs:

When this unit is installed in an explosive atmosphere, the network cables shall be properly fixated by the use of cable ties, or similar, to reduce the risk of accidentally withdraw the plugs.

Conductor temperature:

When this unit is installed in locations with high ambient temperature, special precautions shall be taken upon the choice of external conductors and the temperature rating of the conductor(s).

Directive 94/9/EC alongside with other directives:

Directive 2004/108/EC (EMC) applies and to assure a safe performance of this unit under the scope of Directive 94/9/EC, refer to the electromagnetic immunity level specified under *Type tests and environmental conditions* in this manual.

Warning marking

When this unit is installed in an explosive atmospheres, the warning label submitted together with this unit shall be attached on the unit and visible to the end user.

Standards and date of compliance

EN 60079-0 and EN 60079-15
2010-11-25

Declaration of Conformity



Westermo Teleindustri AB

Declaration of conformity

The manufacturer Westermo Teleindustri AB
SE-640 40 Stora Sundby, Sweden

Herewith declares that the product(s)

Type of product	Model	Art no
Industrial Ethernet Switch	RFI-Series	3641-3xxx
	RFI-Special	3649-0xxx

is in conformity with the following EC directive(s).

No	Short name
2004/108/EC	Electromagnetic Compatibility (EMC)
94/9/EC ¹	Equipment Explosive Atmospheres (ATEX)
2011/65/EU	Restriction of the use of certain hazardous substances in electrical and electronic equipment (RoHS)

References of standards applied for this EC declaration of conformity.

No	Title	Issue
EN 50121-4	Railway applications – Electromagnetic compatibility – Emission and immunity of the signalling and telecommunications apparatus	2006
EN 55022	Information technology equipment – Radio disturbance characteristics – Limits and methods of measurement	2006 +A1:2007
EN 55024	Information technology equipment – Immunity characteristics Limits and methods of measurement	1998 +A1:2001 +A2:2003
EN 61000-6-1	Electromagnetic compatibility – Immunity for residential environments	2007
EN 61000-6-2	Electromagnetic compatibility – Immunity for industrial environments	2005
EN 61000-6-4	Electromagnetic compatibility – Emission for industrial environments	2007
EN 60079-0 ¹	Explosive atmospheres Equipment – General requirements	2009
EN 60079-15 ¹	Electrical apparatus for explosive gas atmospheres – Construction, test and marking of type of protection “n” electrical apparatus	2005

The last two digits of the year in which the CE marking was affixed: 12

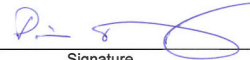
Signature

Pierre Öberg
Technical Manager
27th November 2012

¹ Applicable only for RFI-Series with article no. 3641-3100, -3110, -3200, -3210, -3300 and -3310.

Postadress/Postal address	Tel	Telefax	Postgiro	Bankgiro	Org.nr/ Corp. identity number	Registered office
S-640 40 Stora Sundby Sweden	016-428000 Int+46 16428000	016-428001 Int+46 16428001	52 72 79-4	5671-5550	556361-2604	Eskilstuna

Type tests and environmental conditions

Phenomena	Test	Description	Test levels
ESD	EN 61000-4-2	Enclosure contact	± 6 kV
		Enclosure air	± 8 kV
RF field AM modulated	IEC 61000-4-3	Enclosure	20 V/m 80% AM (1 kHz), 80 – 2700 MHz
Fast transient	EN 61000-4-4	Signal ports	± 2 kV
		Power ports	± 2 kV
Surge	EN 61000-4-5	Signal ports unbalanced	± 2 kV line to earth, ± 2 kV line to line
		Signal ports balanced	± 2 kV line to earth, ± 1 kV line to line
		Power ports	± 2 kV line to earth, ± 1 kV line to line
RF conducted	EN 61000-4-6	Signal ports	10 V 80% AM (1 kHz), 0.15 – 80 MHz
		Power ports	10 V 80% AM (1 kHz), 0.15 – 80 MHz
Power frequency magnetic field	EN 61000-4-8	Enclosure	Not susceptible to magnetic fields
Pulse magnetic field	EN 61000-4-9	Enclosure	300 A/m
Voltage dips and interruption	EN 61000-4-29	DC power ports	10 & 100 ms, interruption
			10 ms, 30% reduction 10 ms, 60% reduction +20% above & -20% below rated voltage
Radiated emission	EN 55022	Enclosure	Class A
	FCC part 15	Enclosure	Class A
Conducted emission	EN 55022	DC power ports Telecommunication ports Class B	Class B
Dielectric strength	EN 60950	Signal port to other isolated ports	1.5 kVrms 50 Hz 1 min
		Power port to other isolated ports	1.5 kVrms 50 Hz 1 min
Temperature		Operating	-40 to +70°C (-40 to +158°F) (all models*)
		Storage & Transport	-40 to +85°C (-40 to +185°F) (all models)
		Maximum surface temperature	135°C (temperature class T4)
Humidity		Operating	5 to 95% relative humidity
		Storage & Transport	5 to 95% relative humidity
Altitude		Operating	2 000 m / 70 kPa
Service life		Operating	10 year
Vibration	IEC 60068-2-6	Operating	7.5 mm, 5 – 8 Hz 2 g, 8 – 500 Hz (Wall-mounted or DIN-rail mounted using TH 35-15 according to EN 60175)
Shock	IEC 60068-2-27	Operating	15 g, 11 ms (Wall-mounter or DIN-rail mounted using TH 35-15 according to EN 60175)
Enclosure	UL 94	Aluminium / Zink	Flammability class V-0 (all models)

* Note: RFI10-F4G-T4G and RFI18-F4G-T4G needs forced airflow to handle operating temperature above +60°C. This can be achieved using an external fan or similar. Without forced airflow maximum operating temperature is +60°C. Refer also to "Safety" section.

Description

The RedFox Industrial includes a collection of high performance industrial Ethernet switches with enhanced routing functionality designed to build cost effective, secure and reliable networks. The product range offers a number of Ethernet interface combinations, which gives you the ability to select the perfect routing switch for your application providing optimum functionality at the best value.

Advanced routing functions and firewall settings allow the RedFox to segregate networks and ensure that mission critical industrial networks are protected. The RedFox is also able to provide secure remote access to these networks across insecure connections by acting as a VPN endpoint.

RedFox Industrial

The listed RedFox have different combinations of interface modules, on the power CPU board two 100BaseTX Ethernet interfaces is available.

Westermo article number	Denomination	Description
3641-3110	RFI-10	2 slot RFI with power and CPU plus one 8x100BaseTX copper ports
3641-3100	RFI-18	3 slot RFI with power and CPU plus two 8x100BaseTX copper ports
3641-3200	RFI-14-F4G	3 slot RFI with power and CPU plus one 8x100BaseTX copper ports and 4xSFP slots
3641-3210	RFI-6-F4G	2 slot RFI with power and CPU plus 4xSFP slots
3641-3300	RFI-18-F4G-T4G	3 slot RFI with power and CPU plus one 8x100BaseTX copper ports, 4xSFP slots and 4X1000baseT
3641-3310	RFI-10-F4G-T4G	2 slot RFI with power and CPU plus 4xSFP slots and 4x1000BaseT
3641-3420	RFI18-F16	3 slot RFI with power and CPU plus two 8x100BaseFX slots
3641-3410	RFI-10-F8	2 slot RFI with power and CPU plus one 8x100BaseFX slot
3641-3220	RFI-14-F4G-F8	3 slot RFI with power and CPU plus one 4xSFP slot and one 8x100BaseFX slot
3641-3320	RFI-18-F4G-T4G-F8	3 slot RFI with power and CPU plus one 4xSFP and 4x1000BaseTX slot and one 8x100BaseFX slot
3641-3400	RFI-18-F8	3 slot RFI with power and CPU plus one 8x100BaseTX slot and one 8x100BaseFX slot

Housing

Description

Depending on RedFox model, the size of the enclosure may vary. There are two sizes available, a two-slot housing and a three-slot housing.

Regardless of RedFox model, the slot on the far left will always be occupied by the power and CPU interface. Other slots vary depending on RedFox model.

The back end holds a casted DIN-clip for stable mounting on a DIN-rail. Direct wall-mount is also possible using the four brackets in each corner. The back end also holds the earth connection. For detailed ground connection information see section on Earth Connection.

2 and 3 slot enclosure

The slot on the left will always be occupied by the power and CPU. Other slots may vary depending on RedFox model.

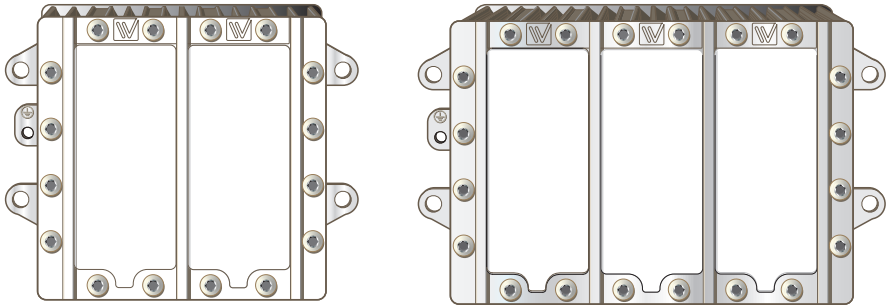

Specification

	2 slot enclosure	3 slot enclosure
Dimension W x H x D	134 x 105 x 122 mm (without connectors)	175 x 105 x 122 mm (without connectors)
Weight	1.5 kg	2.2 kg
Number of slots	2	3
Degree of protection	IP40 according to EN 60529	IP40 according to EN 60529
Cooling	Convection	Convection
Mounting	Horizontal on 35 mm DIN-rail or wall-mounted	Horizontal on 35 mm DIN-rail or wall-mounted

Power and CPU module

Description

Regardless of RedFox model, all units will be delivered with the power and CPU interface in the slot on the far left. The power and CPU module holds a power board and a CPU board. The isolated power supply has redundant power inputs and allows for a wide operating voltage range (see interface specification). The digital IO-port can be used for monitoring the unit (see Westermo OS management guide).

The CPU module holds several interfaces. Two RJ-45 connectors with support for Ethernet 100BaseTX, a USB port for easy save/load of system configuration and a console port for management through serial cable. Use SSH or the Westermo serial diagnostic cable (1211-2027) when connecting to the CLI through the console port.

For detailed information on LED indicators, see section on LED indicators Power/CPU.

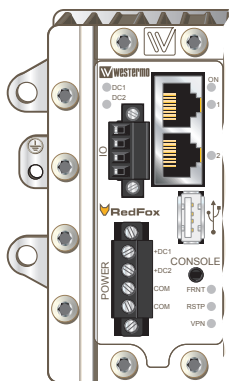

Power and CPU

- ⌘ Redundant power supply and alarm function
- ⌘ Wide operating voltage range (16 VDC to 60 VDC)
- ⌘ Digital IO for monitoring
- ⌘ Console port for management using CLI
- ⌘ USB port for easy save and load system configuration
- ⌘ 2 × RJ-45 Ethernet 100BaseTX connectors
- ⌘ Status LED's

Interface specifications

Power and CPU	
Rated voltage	20 to 48 VDC
Operating voltage	16 to 60 VDC
Rated current (for CPU and power)	410 mA @ 20 VDC 190 mA @ 48 VDC
Rated frequency	DC
Polarity	Reverse polarity protected
Redundant power input	Yes
Isolation to	All other
Connection	Detachable screw terminal
Connector size	0.2 – 2.5 mm ² (AWG 24 – 12)
Shielded cable	Not required

Console	
Electrical specification	TTL-level
Data rate	115.2 kbit/s
Data format	8 data bits, none parity, 1 stop bit, no flow control
Circuit type	SELV
Isolation to	All other except USB
Galvanic connection to	USB
Connection	2.5 mm jack, use only Westermo cable 1211-2027

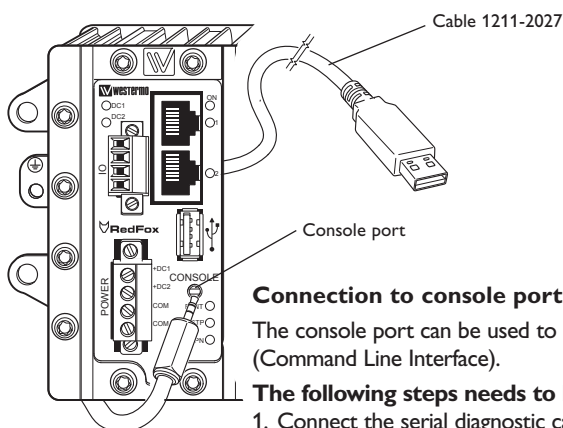

Connection to console port

The console port can be used to connect to the CLI (Command Line Interface).

The following steps need to be taken

1. Connect the serial diagnostic cable to the console port (use only Westermo cable 1211-2027).
2. Connect cable to your computer (USB port, if drivers are needed they can be downloaded from our Web page).
3. Use a terminal emulator and connect with correct speed and format to the assigned port.

For more information about the CLI, see the WeOS management guide.

USB	
Electrical specification	USB 2.0 host interface
Data rate	Up to 12 Mbit/s (full-speed mode)
Circuit type	SELV
Maximum supply current	500 mA
Isolation to	All other except Console
Connection	USB receptacle connector type A
Conductive housing	Yes

IO / Relay output	
Connect resistance	30 Ω
Isolation to	All other
Connection	Detachable screw terminal
Connector size	0.2 – 2.5 mm ² (AWG 24 – 12)
Maximum voltage/current	60 VDC / 80 mA

IO / Digital input	
Voltage levels	Logic one >12V, Logic zero <1V
Isolation to	All other
Connection	Detachable screw terminal
Connector size	0.2 – 2.5 mm ² (AWG 24 – 12)
Maximum voltage	60 VDC

Ethernet TX	
Electrical specification	IEEE std 802.3. 2005 Edition
Data rate	10 Mbit/s or 100 Mbit/s, manual or auto
Duplex	Full or half, manual or auto
Circuit type	TNV-1
Transmission range	Up to 150 m (492 ft) with CAT5e cable or better*
Isolation to	All other
Connection	RJ-45 auto MDI/MDI-X
Shielded cable	Not required, except when installed in Railway applications as signalling and telecommunications apparatus and located close to rails*
Conductive housing	Yes
Number of ports	2

* **NOTE!** Railway installation close to the rails.

To minimise the risk of interference, a shielded cable is recommended when the cable is located inside 3 m boundary to the rails and connected to this port.

The cable shield should be properly connected (360°) to an earthing point within 1 m from this port. This earthing point should have a low impedance connection to the conductive enclosure of the apparatus cabinet, or similar, where the unit is built-in. This conductive enclosure should be connected to the earthing system of an installation and may be directly connected to the protective earth. Refer also to "Safety" section.

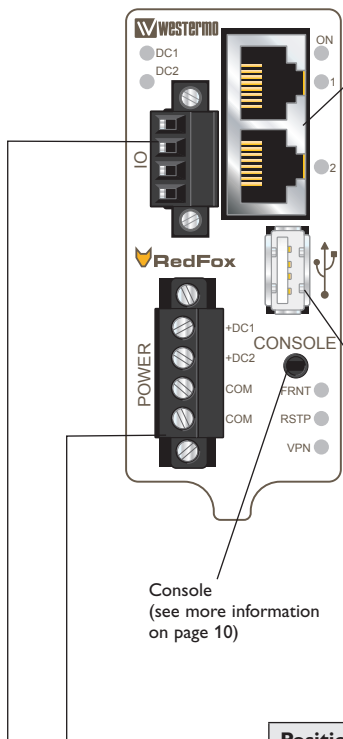

Position	Direction*	Description
1	In/Out	TD+
2	In/Out	TD-
3	In/Out	RD+
4	-	Not connected
5	-	Not connected
6	In/Out	RD-
7	-	Not connected
8	-	Not connected
Shield	In/Out	Connected to PE

Position	Direction*	Description
1	Out	VBUS
2	In/Out	D-
3	In/Out	D+
4	Out	GND
Shield	In/Out	Connected to PE

Console
(see more information
on page 10)

Position	Direction*	Description	Product marking
1	In	+DC1	+DC1
2	In	+DC2	+DC2
3	In	COM	COM
4	In	COM	COM

Position	Direction*	Description
1	Out	Relay output +
2	Out	Relay output -
3	In	Digital in +
4	In	Digital in -

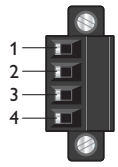

* Direction relative this unit.

LED indicators Power/CPU

LED	Status	Description
ON	OFF	Unit has no power.
	GREEN	All OK, no alarm condition.
	RED	Alarm condition, or until unit has started up. (Alarm conditions are configurable, see "WeOS Management Guide").
	BLINK	Location indicator ("Here I am!"). Activated when connected to IPConfig Tool, or upon request from Web or CLI.
DC1	OFF	Unit has no power.
	GREEN	Power OK on DC1.
	RED	Power failure on +DC1.
DC2	OFF	Unit has no power.
	GREEN	Power OK on DC2.
	RED	Power failure on +DC2.
FRNT	OFF	FRNT disabled.
	GREEN	FRNT OK.
	RED	FRNT Error.
	BLINK	Unit configured as FRNT Focal Point.
RSTP	OFF	RSTP disabled.
	GREEN	RSTP enabled.
	BLINK	Unit elected as RSTP/STP root switch.
VPN	OFF	VPN disabled.
	GREEN	(Configurable) Default: At least one VPN tunnel up and OK.
Copper ports 1-2	OFF	No link.
	GREEN	Link established.
	GREEN FLASH	Data traffic indication.
	YELLOW	Port alarm and no link. Or if FRNT or RSTP mode, port is blocked.

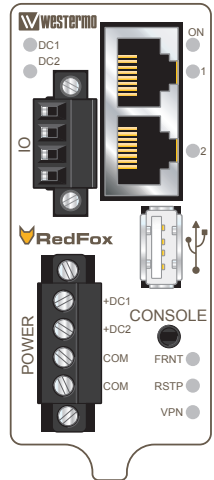

Interface modules

8 copper ports

The interface module with eight copper ports has eight RJ-45 connectors supporting Ethernet 10/100BaseT/TX.

All ports support category 5e cable or better and can handle cable lengths up to 150 m (492 ft).

Interface specifications

8 copper ports	
Rated current	144 mA @ 20 VDC 66 mA @ 48 VDC
Electrical specification	IEEE std 802.3. 2005 Edition
Data rate	10 Mbit/s or 100 Mbit/s, manual or auto
Duplex	Full or half, manual or auto
Circuit type	TNV-1
Transmission range	Up to 150 m with CAT5e cable or better*
Isolation to	All other
Connection	RJ-45 auto MDI/MDI-X
Shielded cable	Not required, except when installed in Railway applications as signalling and telecommunications apparatus and located close to rails*
Conductive housing	Yes
Number of ports	8

* **NOTE!** Railway installation close to the rails.

To minimise the risk of interference, a shielded cable is recommended when the cable is located inside 3 m boundary to the rails and connected to this port.

The cable shield should be properly connected (360°) to an earthing point within 1 m from this port. This earthing point should have a low impedance connection to the conductive enclosure of the apparatus cabinet, or similar, where the unit is built-in. This conductive enclosure should be connected to the earthing system of an installation and may be directly connected to the protective earth. Refer also to "Safety" section.

LED indicators 8 copper ports

LED	Status	Description
Copper ports 1 – 8	OFF	No link.
	GREEN	Link established.
	GREEN FLASH	Data traffic indication.
	YELLOW	Port alarm and no link. Or if FRNT or RSTP mode, port is blocked.

Position	Direction*	Description
1	In/Out	TD+
2	In/Out	TD-
3	In/Out	RD+
4	-	Not connected
5	-	Not connected
6	In/Out	RD-
7	-	Not connected
8	-	Not connected
Shield	In/Out	Connected to PE

* Direction relative this unit.

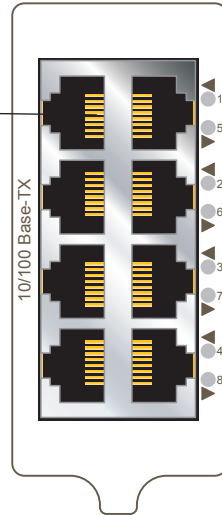

F4G, 4 SFP slots

The F4G interface has four SFP slots supporting Ethernet 10/100/1000BaseFX/X. Each slot can hold one SFP transceiver for copper or fibre cable. Fibre transceiver distances range from 550 m (0.34 mi) to 120 km (74,6 mi). For supported transceivers see section on SFP transceivers.

Interface specifications

F4G	
Rated current	360 mA @ 20 V 165 mA @ 48 VDC
Optical/Electrical specification	IEEE std 802.3. 2005 Edition
Data rate	10, 100 or 1000 Mbit/s*
Duplex	Full or half, manual or auto
Transmission range	Depending on transceiver
Connection	SFP slot holding fibre transceiver or copper transceiver
Number of ports	4

* 100 Mbit/s or 1000 Mbit/s transceiver supported.

F8, 8 SFP slots

The F8 interface has eight SFP slots supporting Ethernet 10/100BaseFX. Each slot can hold one SFP transceiver for copper or fibre cable. Fibre transceiver distances range from 550 m (0.34 mi) to 120 km (74,6 mi). For supported transceivers see section on SFP transceivers.

Interface specifications

F8	
Rated current	350 mA @ 20 V 140 mA @ 48 VDC
Optical/Electrical specification	IEEE std 802.3. 2005 Edition
Data rate	10 or 100 Mbit/s*
Duplex	Full or half, manual or auto
Transmission range	Depending on transceiver
Connection	SFP slot holding fibre transceiver or copper transceiver
Number of ports	8

* 10 Mbit/s or 100 Mbit/s transceiver supported.

LED indicators F4G

LED	Status	Description
Fibre ports 1 – 4	OFF	No link.
	GREEN	Link established.
	GREEN FLASH	Data traffic indication.
	YELLOW	Port alarm and no link. Or if FRNT or RSTP mode, port is blocked.

Position	Direction*	Description
Rx	In	Receive port
Tx	Out	Transmit port

* Direction relative this unit.

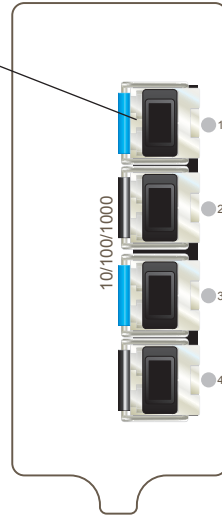

LED indicators F8

LED	Status	Description
Fibre ports 1 – 8	OFF	No link.
	GREEN	Link established.
	GREEN FLASH	Data traffic indication.
	YELLOW	Port alarm and no link. Or if FRNT or RSTP mode, port is blocked.

Position	Direction*	Description
Rx	In	Receive port
Tx	Out	Transmit port

* Direction relative this unit.

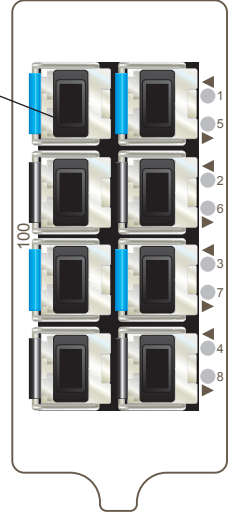

F4G-T4G, 4 SFP slots and 4 Gbit copper ports

The F4G-T4G interface has four SFP slots supporting Ethernet BaseFX/X and four RJ-45 connectors supporting Ethernet 10/100/1000BaseTX/T. Each SFP slot can hold one SFP transceiver for copper or fibre cable. Fibre transceiver distances range from 550 m (0.34 mi) to 120 km (74,6 mi).

For supported transceivers see section on SFP transceivers.

All ports support category 5e cable or better and can handle cable lengths up to 150 m (492 ft).

Interface specifications

F4G-T4G	
Rated current	792 mA @ 20 V 364 mA @ 48 V

Fixed copper ports (RJ-45)	
Electrical specification	IEEE std 802.3. 2005 Edition
Data rate	10, 100 or 1000 Mbit/s
Duplex	Full or half, manual or auto
Circuit type	TNV-1
Transmission range	Up to 150 m with CAT5e cable or better*
Isolation to	All other
Connection	RJ-45 auto MDI/MDI-X
Shielded cable	Not required, except when installed in Railway applications signalling and telecommunications apparatus and located close to rails*
Conductive housing	Yes
Number of ports	4

* **NOTE!** Railway installation close to the rails.

To minimise the risk of interference, a shielded cable is recommended when the cable is located inside 3 m boundary to the rails and connected to this port.

The cable shield should be properly connected (360°) to an earthing point within 1 m from this port. This earthing point should have a low impedance connection to the conductive enclosure of the apparatus cabinet, or similar, where the unit is built-in. This conductive enclosure should be connected to the earthing system of an installation and may be directly connected to the protective earth. Refer also to "Safety" section.

SFP ports	
Optical/Electrical specification	IEEE std 802.3. 2005 Edition
Data rate	10, 100 or 1000 Mbit/s*
Duplex	Full or half, manual or auto
Transmission range	Depending on transceiver
Connection	SFP slot holding fibre transceiver or copper transceiver
Number of ports	4

* 100 Mbit/s or 1000 Mbit/s transceiver supported.

LED indicators F4G-T4G

LED	Status	Description
Copper ports 1 – 4 Fibre ports 5 – 8	OFF	No link.
	GREEN	Link established.
	GREEN FLASH	Data traffic indication.
	YELLOW	Port alarm and no link. Or if FRNT or RSTP mode, port is blocked.

Position	Direction*	Description
1	In/Out	BI_DA+
2	In/Out	BI_DA-
3	In/Out	BI_DB+
4	In/Out	BI_DC+
5	In/Out	BI_DC-
6	In/Out	BI_DB-
7	In/Out	BI_DD+
8	In/Out	BI_DD-
Shield	In/Out	Connected to PE

* Direction relative this unit

Position	Direction*	Description
Rx	In	Receive port
Tx	Out	Transmit port

* Direction relative this unit.

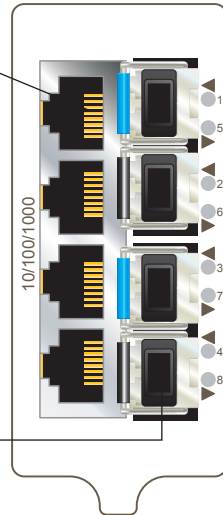

Current consumption calculation

Current consumption values described for each interface is the current consumption for that interface only. To calculate the total current consumption values shall be added together.

For example a unit with the following configuration will be calculated as follows:

Used modules	Consumption
Power and CPU	410 mA @ 20 VDC
8 copper ports	144 mA @ 20 VDC
F4G	360 mA @ 20 VDC

Adding the values will give a total consumption of 914 mA @ 20 VDC.

External power supply must be rated to meet the calculated current.

Westermo recommends external power supply to be rated for a startup current which is at least twice the calculated in service consumption. In the example above an external power supply must be rated for at least 1828 mA for startup current.

SFP Transceivers

See SFP Transceivers User Guide 6100-000 for supported SFP transceivers.

Note: The unit supports Westermo labelled transceivers only.

Deviations

With *copper transceiver* 1100-0148 the specified operating temperature on the RFI-series is 0 to 50°C.

FRNT reconfiguration times can not be guaranteed with copper transceivers.



Mounting

Mounting, 35 mm DIN-rail

The unit can be mounted on a 35 mm DIN-rail, which is horizontally mounted inside an apparatus cabinet, or similar. Snap on mounting, see figure.

Note! For proper vibration and chock performance Westermo recommends standard top-hat DIN-rail TH 35-15 according to EN 60715.

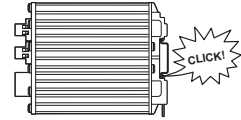
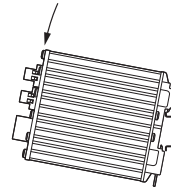

Removal

Press down the support at the back of the unit using a screwdriver. See figure.

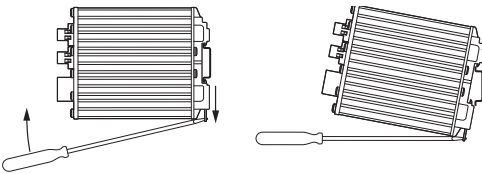

Wall mounting

This unit can also be wall-mounted, see figure.

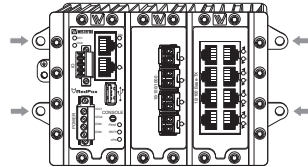

Earth connection

For correct function the ground connection on the unit needs to be properly connected to a solid ground. See figure.

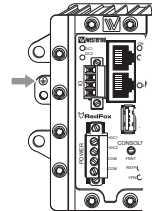

Cooling

This unit uses convection cooling. To avoid obstructing the airflow around the unit, use the following spacing rules. Minimum spacing 25 mm (1.0 inch) above /below and 10 mm (0.4 inches) left /right the unit.

Spacing is recommended for the use of unit in full operating temperature range and service life. See figure.

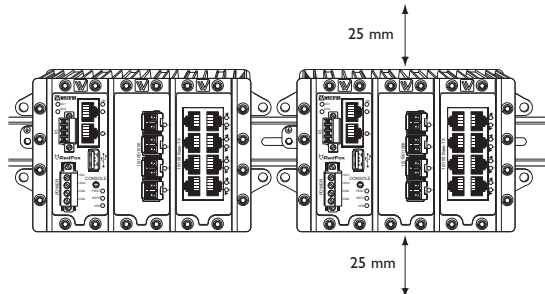

Getting Started

This product runs Westermo Operating System (WeOS) which provides several management tools that can be used for configuration of the unit.

- **IPConfig tool**
This is a custom Westermo tool used for discovery of attached Westermo units.
- **Web**
Configuration of the unit using the web browser.
- **CLI**
Configuration of the unit via the Command Line Interface.

If the computer is located in the same subnet as the switch you can easily use a web browser to configure the unit. Within the web you can configure most of the available functions.

For advanced network settings and more diagnostic information, please use the CLI. Detailed documentation is available in the chapter "The Command Line Management Tool" in the WeOS management guide.

Factory default	<i>IP address:</i>	192.168.2.200
	<i>Netmask:</i>	255.255.255.0
	<i>Gateway:</i>	Disabled

Note! If you are not sure about the subnet – consult your network administrator.

Configuration

Configure the unit via Webbrowser

The unit can easily be configured via a Web browser.

Open the link <http://192.168.2.200> in your web browser, and you will be prompted with a Login screen, where the default settings for Username and Password are:

Username: admin

Password: westermo

Once you have logged in, you can use the extensive integrated help function describing all configuration options. Two common task when configuring a new switch is to assign appropriate IP settings, and to change the password of the admin account.

The password can be up to 64 characters long, and should consist of printable ASCII characters (ASCII 33-126); 'Space' is not a valid password character.

Note! Version of IP Config tool must be 10.3.0 or higher.

Referring documents

Type	Description	Document number
Management Guide	Westermo OS management guide	6101-3201

Factory default on RedFox Industrial

It is possible to set the unit to factory default settings by using a standard Ethernet RJ-45 cable.

1. Power off the switch and disconnect all Ethernet cables (copper and fibre).
 2. Connect an Ethernet cable between Ethernet port 1/1 and Ethernet port 1/2 (that is, connect Ethernet ports 1 and 2 on in the leftmost slot by an Ethernet cable). The ports need to be connected directly by an Ethernet cable, i.e., not via a hub or switch. Use a straight cable – not a cross-over cable – when connecting the ports.
 3. Power on the unit.
 4. Wait for the unit to start up. Control that the ON LED is flashing red.
The ON LED flashing indicates that the unit is now ready to be reset to factory default. You now have the choice to go ahead with the factory reset, or to skip factory reset and boot as normal.
 - Go ahead with factory reset:
Acknowledge that you wish to conduct the factory reset by unplugging the Ethernet cable. The ON LED will stop flashing.
This initiates the factory reset process*, and after approximately 1 minute the unit will restart with factory default settings. When the switch has booted up, the ON LED will typically show a green light (a red light is shown if only one of the DC power feeds is connected).
 - Skip the factory reset:
To skip the factory reset process, just wait for approximately 30 seconds (after the ON LED starts flashing RED) without unplugging the Ethernet cable. The switch will conduct a normal boot with the existing settings.
- * **Note** Do not power off the unit while the factory reset process is in progress.



Westermo • SE-640 40 Stora Sundby, Sweden
Tel +46 16 42 80 00 Fax +46 16 42 80 01
E-mail: info@westermo.com
www.westermo.com

Sales Units

Sweden

Westermo Data Communications
Svalgängen 1, Vallbyinstitutet, 724 81 Västerås
Tel: +46 (0) 21 548 08 00 • Fax: (0) 21 35 18 50
info.sverige@westermo.se • www.westermo.se

United Kingdom

Westermo Data Communications
Talisman Business Centre
Duncan Road, Park Gate, Southampton. SO31 7GA
Tel: +44 (0) 1489 580 585 • Fax: +44 (0) 1489 580 586
sales@westermo.co.uk • www.westermo.co.uk

Germany

Westermo Data Communications
Goethe Strasse 67
DE-68753 Waghäusel
Tel: +49 (0) 7254 95400-0 • Fax: +49 (0) 7254-95400-9
info@westermo.de • www.westermo.de

Austria

Westermo Data Communications
Tel: +43 (0) 72030 3920 • Fax: +43 (0) 2235 86131
info@westermo.at • www.westermo.at

France

Westermo Data Communications
Bat. A, 9 Chemin de Chilly
FR-91160 Champlan
Tel: +33 1 69 10 21 00 • Fax: +33 1 69 10 21 01
infos@westermo.fr • www.westermo.fr

Singapore

Westermo Data Communications
2 Soon Wing Road #08-05,
Soon Wing Industrial Building
Singapore 347893
Tel: +65 6743 9801 • Fax: +65 6745 0670
sales@westermo.com.sg • www.westermo.com.sg

North America

Westermo Data Communications
939 N. Plum Grove Road, Suite F,
IL 60173 Schaumburg, USA
Tel: +1 847 619 6068 • Fax: +1 847 619 66 74
info@westermo.com • www.westermo.com

Taiwan

Westermo Data Communications
F2, No. 188, Pao-Chiao Rd. Shing-Tien City,
Taipei 23145
Tel: +886 2 8911 1710
sales.cn@westermo.com • www.cn.westermo.com

China

Westermo Data Communications
2F Building B
No.1618 Yishan Road
Shanghai 201103
Tel: +86 21 6145 0400 • Fax: +86 21 6145 0499
sales.cn@westermo.com • www.cn.westermo.com

Westermo Teleindustri AB have distributors in several countries, contact us for further information.