

User Guide
6641-2222

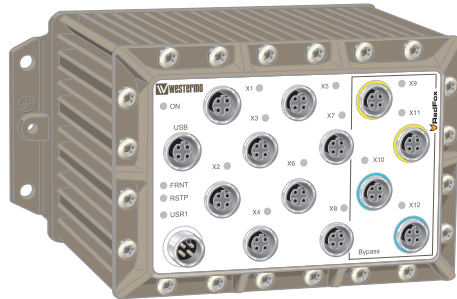

RedFox

R A I L



*Ethernet switch and router
approved for railway usage*

www.westermo.com



Software tools

Related software tools are available in the folder software tools under technical support on the Westermo website.

License Information

This device contains public available software which is under the GPL license. For more information see legal.pdf included with all firmware releases.

This product includes software developed by the OpenSSL Project for use in the OpenSSL Toolkit, <http://www.openssl.org>

Legal information

The contents of this document are provided "as is". Except as required by applicable law, no warranties of any kind, either express or implied, including, but not limited to, the implied warranties of merchantability and fitness for a particular purpose, are made in relation to the accuracy and reliability or contents of this document. Westermo reserves the right to revise this document or withdraw it at any time without prior notice.

Under no circumstances shall Westermo be responsible for any loss of data or income or any special, incidental, and consequential or indirect damages howsoever caused.

More information about Westermo can be found at the following Internet address:

<http://www.westermo.com>

Safety



Before installation:

Read this manual completely and gather all information on the unit. Make sure that you understand it fully. Check that your application does not exceed the safe operating specifications for this unit.

This unit should only be installed by qualified personnel.

This unit should be built-in to an apparatus cabinet, or similar, where access is restricted to service personnel only. The DC main supply shall be connected to protective earth. The power supply wiring must be sufficiently fused, recommended fuse: 4 A slow. It must be possible to manually disconnect power.

Ensure compliance to national installation regulations.

This unit relies on convection heating. Make sure that it is installed so that the ambient temperature is within the specified temperature range, e.g. by avoiding obstruction of the airflow around the unit.



Before mounting, using or removing this unit:

Prevent access to hazardous voltage by disconnecting the unit from all power supply.

WARNING

Do not open connected unit. Hazardous voltage may occur within this unit when connected to power supply.

Before powering-up, a protective earthing conductor must be connected to the protective earthing terminal and have a cross-sectional area of at least 1.5 mm².

When this unit is operated at an ambient temperature above +55°C (+131°F), +55°C (+131°F), the External Surface of Equipment may exceed Touch Temperature Limit according to EN/IEC/UL 60950-1.

To reduce the risk of fire, use only No. 26 AWG or larger telecommunication line cord.

Care recommendations

Follow the care recommendations below to maintain full operation of unit and to fulfill the warranty obligations.

This unit must not be operating with removed covers or lids.

Do not attempt to disassemble the unit. There are not any user serviceable parts inside.

Do not drop, knock or shake the unit. Rough handling above the specification may cause damage to internal circuit boards.

Do not use harsh chemicals, cleaning solvents or strong detergents to clean the unit.

Do not expose the unit to any kind of liquids (rain, beverages, paint etc), unless all connectors and the ventilation membrane are sufficiently protected.

Do not use or store the unit in dusty or dirty areas, unless all connectors and the ventilation membrane are sufficiently protected.

Do not cover or bring mechanical force to the ventilation membrane on the back of the unit.

If the unit is not working properly, contact the place of purchase, nearest Westermo distributor office or Westermo Tech support.

Maintenance

No maintenance is required, as long as the unit is used as intended within the specified conditions.

Agency approvals and standards compliance

Type	Approval / Compliance
EMC	EN 50121-3-2, Railway applications – EMC: Rolling stock – Apparatus
	Railway applications, Approval/Compliance – EN 50155
	Railway applications – Electronic equipment used on rolling stock
Safety	EN 60950-1, IT equipment

Declaration of Conformity



Westermo Teleindustri AB

Declaration of conformity

The manufacturer Westermo Teleindustri AB
SE-640 40 Stora Sundby, Sweden

Herewith declares that the product(s)

Type of product	Model	Art no	
EN 50155 Backbone Routing Switch	RFR-12-FB	3641-1630	

is in conformity with the following EC directive(s).

No	Short name
2004/108/EC	Electromagnetic Compatibility (EMC)
2006/95/EC	Low voltage (LVD)
2011/65/EU	Restriction of the use of certain hazardous substances in electrical and electronic equipment (RoHS)

References of standards applied for this EC declaration of conformity.

No	Title	Issue
EN 50121-3-2	Railway applications - Electromagnetic compatibility -- Rolling stock - Apparatus	2006
EN 60950-1	Information technology equipment - Safety -- General requirements	2006 +A11:2009 +A1:2010 +A12:2011

The last two digits of the year in which the CE marking was affixed: 12

Signature

Pierre Öberg
Technical Manager
21st December 2012

Postaddress/Postal address	Tel.	Telefax	Postgiro	Bankgiro	Org.nr/ Corp. identity number	Registered office
S-640 40 Stora Sundby Sweden	016-428000 Int+46 16428000	016-428001 Int+46 16428001	52 72 79-4	5671-5550	556361-2604	Eskilstuna

Type tests and environmental conditions

Electromagnetic Compatibility			
Phenomena	Standard	Description	Test Levels
ESD	EN 61000-4-2	Enclosure contact discharge immunity	±6 kV
		Enclosure air discharge immunity	±8 kV
RF field AM modulated	EN 61000-4-3	Enclosure RF immunity	20 V/m 80 – 2700 MHz
Fast transients	EN 61000-4-4	Signal port immunity	±2 kV
		Power port immunity	±2 kV
Surges	EN 61000-4-5	Power port immunity	±2 kV (L-E) ±1 kV (L-L)
	EN 50155:2001	Power port immunity	±8.4 kV (L-E) ±8.4 kV (L-L)
Conducted RF emission	EN 61000-4-6	Signal port immunity	10 V/m 0.15 – 80 MHz
		Power port immunity	10 V/m 0.15 – 80 MHz
Power frequency magnetic field	EN 61000-4-8	Enclosure immunity	300 A/m 0, 16.7, 50 Hz
Pulsed magnetic field	EN 61000-4-9	Enclosure immunity	300 A/m
Voltage interruption	EN 50155	Residual voltage 0%	10 ms
Supply overvoltage and undervoltage	EN 50155	Overvoltage 140% Residual voltage 60%	100 ms & 1000 ms 100 ms
Radiated emission	EN 55011 Limits: EN 50121-3-2	Enclosure measurement	40 dB μ V/m QP 30 – 230 MHz 47 dB μ V/m QP 230 – 1000 MHz
Conducted emission	EN 55011 Limits: EN 50121-3-2	Power port measurement	99 dB μ V QP 0.15 – 5 MHz 93 dB μ V QP 5 – 30 MHz
		Signal port measurement	99 dB μ V QP 0.15 – 5 MHz 93 dB μ V QP 5 – 30 MHz
Environmental			
Temperature		Operating	-40 to +70°C (-40 to +158°F)
		Storage & Transport	-40 to +70°C (-40 to +158°F)
Humidity		Operating	5 to 95% relative humidity
		Storage & Transport	5 to 95% relative humidity
Altitude		Operating	2 000 m / 70 kPa
Reliability prediction (MTBF)	MIL-HDBK- 217F	Operating	306 115 h
	IEC 60068-2-64	Operating	Vertical 2.0 m/s ² Transverse 2.0 m/s ² Longit. 2.0 m/s ²
		Non operating	11.4 m/s ²
Shock	IEC 60068-2-27	Operating	10 g, 30 ms Half sine ±3 shocks
	IEEE 1478	Operating	20 g, 11 ms Saw tooth ±3 shocks
Packaging			
Dimension W x H x D			175 x 100 x 144 mm
Weight			2295 g
Degree of protection	IEC 529	Enclosure	IP65
Cooling			Convection
Mounting			Rear panel wall mounting

Description

Functional description

RFR-12-FB is switch developed for rail on board and industrial applications approved according to EN 50155. To meet the environmental requirements from rail and harsh industrial applications the switch has rugged M12 Ethernet connectors and full metal housing. The switch fulfill IP 65 degree of protection. Our unique FRNT (Fast Recovery of Network Topology) technology is the fastest protocol on the market to re-configure a network in the event of any failure of a link or hardware. Real-time properties are implemented in the RFR-12-FB in order to achieve determinism for real time critical applications. The switch also supports QoS (Quality of Service) with four priority queues and strict priority scheduling as well as HoL (Head of Line Blocking Prevention). All to assure that the data network is deterministic. RFR-12-FB also has a by-pass relay that by-pass the unit in case of power loss to the switch.

Interface specifications

Power	
Rated voltage	24 to 110 VDC
Operating voltage	16.8 to 143 VDC (14.4 to 154 VDC for 100 ms)
Rated current	580 mA @ 24 VDC 140 mA @ 110 VDC
Inrush current	5 mA ² s @ 24 VDC 22 mA ² s @ 110 VDC
Startup current (Power source capability)	600 mA @ 24 VDC 275 mA @ 110 VDC
Polarity	Reverse polarity protected
Redundant power input	No
Isolation to	All interfaces and chassis
Galvanic connection to	None
Connection	M12 A-coded male
Connector size	0.2 – 2.5 mm ² (AWG 24 – 13)
Shielded cable	Not required
Shielded cable	Not required
Miscellaneous	–



M12 A-Coded Power Connector

Position	Direction	Description
1	U+	Positive supply voltage
2	–	–
3	0V	0V
4	–	–
Housing	Shield	Chassis of product (ground)

Ethernet TX (both switch, router and coupler ports)	
Electrical specification	IEEE std 802.3. 2000 Edition
Data rate	10 Mbit/s or 100 Mbit/s, manual or auto
Protocol	–
Duplex	Full or half, manual or auto
Circuit type	TNV-1
Transmission range	100 m
Isolation to	All interfaces and chassis
Galvanic connection to	None
Connection	M12 D-coded
Shielded cable	Yes
Conductive housing	Yes
Miscellaneous	–
Number of ports	12

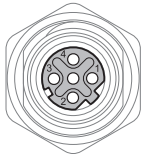

M12 D-coded, 10/100Base-TX

Position	Direction	Description
1	Out	Transmit Data +
2	In	Receive Data +
3	Out	Transmit Data –
4	In	Receive Data –
Housing	Shield	Chassis of product (ground)

Configuration backup device	
Electrical specification	USB
Memory size	16 Mbyte
Protocol	USB v1.1
Connection	M12 A-coded female
Isolation to	All interfaces, but not to chassis
Shielded cable	NA
Miscellaneous	–

USB / Configuration

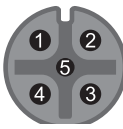
Pin number	Signal	
No 1	DN	
No 2	VBUS	
No 3	NC	
No 4	DP	
No 5	GND	

The agency approvals and standards compliance of the RFR-12 are valid with the WESTERMO USB configuration plug 3641-0190 attached. Only WESTERMO USB plugs are allowed for use together with this product.

Location of Interface ports, LED's

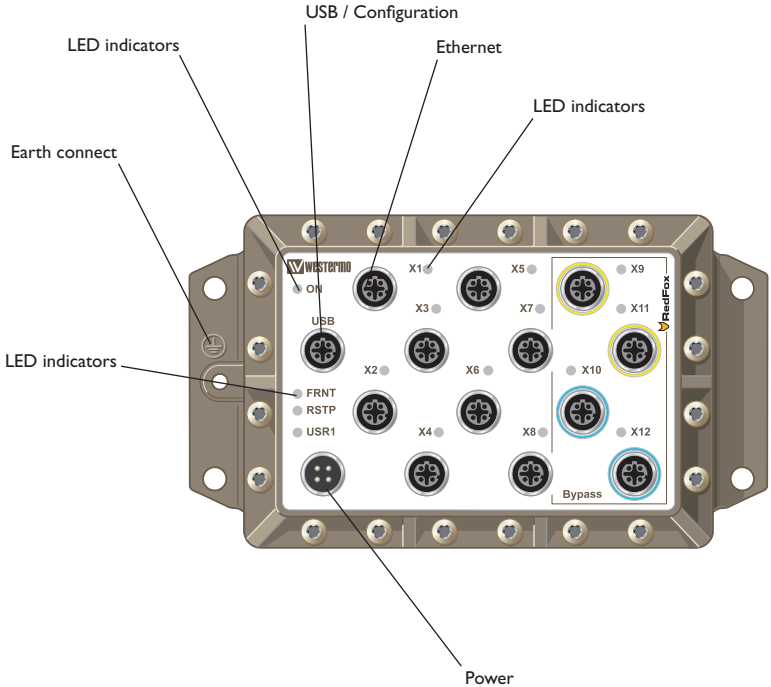

LED indicators

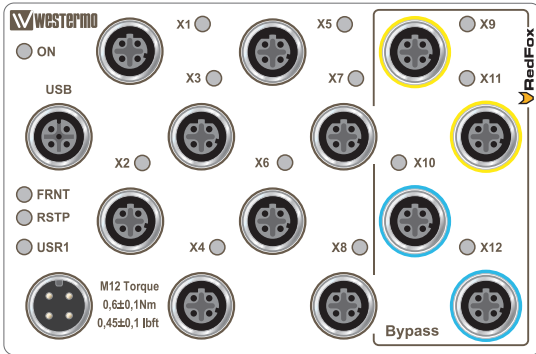

LED	Status	Description
ON	OFF	Unit has no power.
	GREEN	All OK, no alarm condition.
	RED	Alarm condition, or until unit has started up. (Alarm conditions are configurable, see "WeOS Management Guide").
	BLINK	Location indicator ("Here I am!"). Activated when connected to IPConfig Tool, or upon request from Web or CLI.
FRNT	OFF	FRNT disabled.
	GREEN	FRNT OK.
	RED	FRNT Error.
	BLINK	Unit configured as FRNT Focal Point.
RSTP	OFF	RSTP disabled.
	GREEN	RSTP enabled.
	BLINK	Unit selected as RSTP root switch.
USR 1	OFF	(Configurable) VPN disabled.
	GREEN	(Configurable) Default: At least one VPN tunnel up and OK.
	RED	(Configurable) Default: All VPN tunnels down.
X1 to X12	OFF	No Link.
	GREEN	Link established.
	GREEN FLASH	Data traffic indication.
	YELLOW	Port alarm and no link. Or if FRNT, RSTP or Link Aggregation mode, port is blocked.

By-Pass functionality

The by-pass functionality in RFR-12-FB secures connection in case of power failure in one of the switches. If a switch has power loss an internal relay in RFR-12-FB will by-pass the switch and bridge two Ethernet ports.

By-pass interfaces

In case of power failure X9 will be by-passed to X11 and X10 will be by-passed to X12.

Internally the switch will bypass		
X9.1	Connected to	X11.2
X9.2		X11.1
X9.3		X11.4
X9.4		X11.3
X10.1		X12.2
X10.2		X12.1
X10.3		X12.4
X10.4		X12.3

Note! Make sure that the maximum distance between switches will not exceed the standard (100 m) in case of by-passing one or more switches.

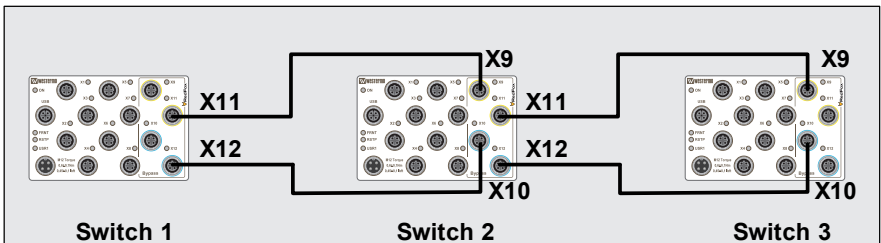

Mounting

There are four 6 mm bore holes intended for mounting the unit. The unit can be mounted vertical or horizontal. Use four M5 screws with 12 mm washer on a flat and stable surface.

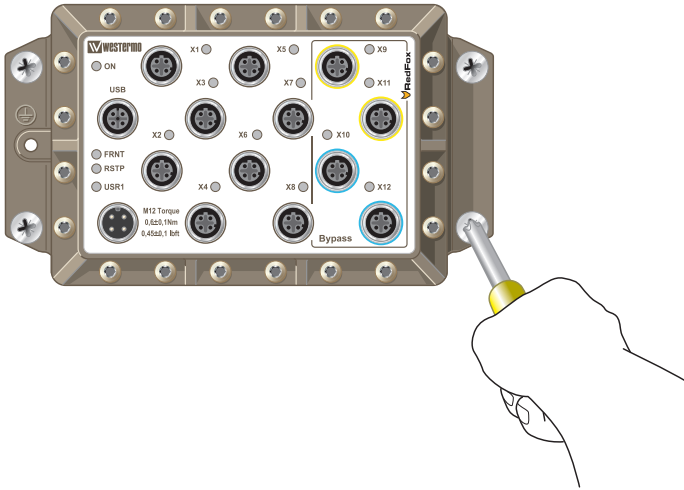

Connection of cables

Recommended tightening torque for the M12 connectors: 0.6 Nm

Removal

Disconnect all cables and unscrew the unit from the wall.

Time For Replacement < 15 minutes

Cooling

This unit relies on convection cooling. Make sure that it is installed so that the ambient temperature is within the specified temperature range, e.g. by avoiding obstruction of the airflow around the unit.

Dimensions

Measurements are stated in millimeters.

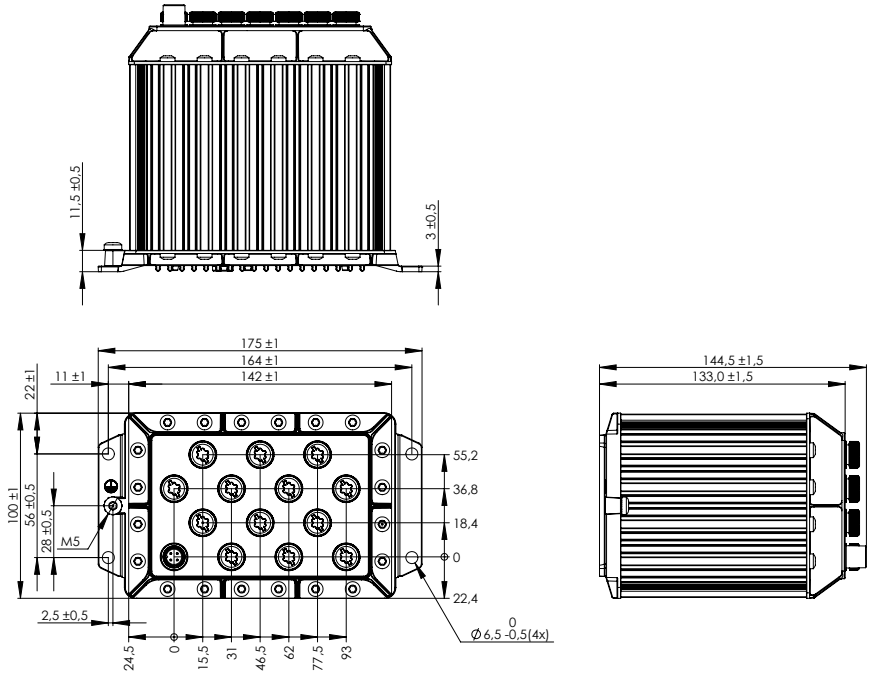

Getting Started

This product runs Westermo Operating System (WeOS) which provides several management tools that can be used for configuration of the unit.

- **IPConfig tool**

This is a custom Westermo tool used for discovery of attached Westermo units.

- **Web**

Configuration of the unit using the web browser.

- **CLI**

Configuration of the unit via the Command Line Interface.

If the computer is located in the same subnet as the switch you can easily use a web browser to configure the unit. Within the web you can configure most of the available functions.

For advanced network settings and more diagnostic information, please use the CLI. Detailed documentation is available in the chapter "The Command Line Management Tool" in the WeOS management guide.

Factory default *IP address:* 192.168.2.200
 Netmask: 255.255.255.0
 Gateway: Disabled

Note! If you are not sure about the subnet – consult your network administrator.

Configuration

Configure the unit via Webbrowser

The unit can easily be configured via a Web browser.

Open the link <http://192.168.2.200> in your web browser, and you will be prompted with a Login screen, where the default settings for Username and Password are:

Username: admin

Password: westermo

Once you have logged in, you can use the extensive integrated help function describing all configuration options. Two common task when configuring a new switch is to assign appropriate IP settings, and to change the password of the admin account.

The password can be up to 64 characters long, and should consist of printable ASCII characters (ASCII 33-126); 'Space' is not a valid password character.

Note! Version of IP Config tool must be 10.4 or higher.

Referring documents

Type	Description	Document number
Management Guide	Westermo OS management guide	6101-3201

Factory default on RFR-12-FB

It is possible to set the unit to factory default settings by using Ethernet M-12 cables.

1. Power off the switch and disconnect all Ethernet cables.
2. Connect the first Ethernet cable between Ethernet port X1 and Ethernet port X6.
Then connect the second Ethernet cable between Ethernet port X2 and Ethernet port X5.

The ports need to be connected directly by an Ethernet cable, i.e., not via a hub or switch. Use a straight cable – not a cross-over cable – when connecting the ports.

3. Power on the unit.
4. Wait for the unit to start up. Control that the ON LED is flashing red.

The ON LED flashing indicates that the unit is now ready to be reset to factory default. You now have the choice to go ahead with the factory reset, or to skip factory reset and boot as normal.

- Go ahead with factory reset:
Acknowledge that you wish to conduct the factory reset by unplugging one of the Ethernet cables. The ON LED will stop flashing.
This initiates the factory reset process*, and the unit will restart with factory default settings. When the switch has booted up, the ON LED will show a green light, and is now ready to use.
- Skip the factory reset:
To skip the factory reset process, just wait for approximately 30 seconds (after the ON LED starts flashing RED) without unplugging the Ethernet cable.
The switch will conduct a normal boot with the existing settings.

* **Note** Do not power off the unit while the factory reset process is in progress.



Westermo • SE-640 40 Stora Sundby, Sweden
Tel +46 16 42 80 00 Fax +46 16 42 80 01
E-mail: info@westermo.com
www.westermo.com

Sales Units

Sweden

Westermo Data Communications
Svalgängen 1, Vallbyinstitutet, 724 81 Västerås
Tel: +46 (0) 21 548 08 00 • Fax: (0) 21 35 18 50
info.sverige@westermo.se • www.westermo.se

United Kingdom

Westermo Data Communications
Talisman Business Centre
Duncan Road, Park Gate, Southampton. SO31 7GA
Tel: +44 (0) 1489 580 585 • Fax: +44 (0) 1489 580 586
sales@westermo.co.uk • www.westermo.co.uk

Germany

Westermo Data Communications
Goethe Strasse 67
DE-68753 Waghäusel
Tel: +49 (0) 7254 95400-0 • Fax: +49 (0) 7254-95400-9
info@westermo.de • www.westermo.de

Austria

Westermo Data Communications
Tel: +43 (0) 72030 3920 • Fax: +43 (0) 2235 86131
info@westermo.at • www.westermo.at

France

Westermo Data Communications
Bat. A, 9 Chemin de Chilly
FR-91160 Champlan
Tel: +33 1 69 10 21 00 • Fax: +33 1 69 10 21 01
infos@westermo.fr • www.westermo.fr

North America

Westermo Data Communications
939 N. Plum Grove Road, Suite F,
IL 60173 Schaumburg, USA
Tel: +1 847 619 6068 • Fax: +1 847 619 66 74
info@westermo.com • www.westermo.com

Singapore

Westermo Data Communications
84 Genting Lane #07-03
Cityneon Design Centre
Singapore 349584
Tel: +65 6743 9801 • Fax: +65 6745 0670
sales@westermo.com.sg • www.westermo.com

Malaysia

Westermo Data Communications
84 Genting Lane #07-03,
Cityneon Design Centre,
Singapore 349584
Tel : +6 012 2781156 • Fax : +603 8062 7467
chinleong.teh@westermo.com.sg • www.westermo.com.sg

China

Westermo Data Communications
2F Building B
No.1618 Yishan Road
Shanghai 201103
Tel: +86 21 6145 0400 • Fax: +86 21 6145 0499
sales.cn@westermo.com • www.cn.westermo.com

Westermo Teleindustri AB have distributors in several countries, contact us for further information.