

Operation and Remote Programming Manual

ML2437A / ML2438A

Power Meter

The Anritsu logo consists of the word "Anritsu" in a bold, sans-serif font. The letter "A" is stylized with a diagonal slash through it.

Anritsu Company
490 Jarvis Drive
Morgan Hill, CA 95037-2809
USA
<http://www.anritsu.com>

Part Number: 10585-00001
Revision: N
Published: June 2014
Copyright 2014 Anritsu Company

WARRANTY

The Anritsu product(s) listed on the title page is (are) warranted against defects in materials and workmanship for three (3) years from the date of shipment.

Anritsu's obligation covers repairing or replacing products which prove to be defective during the warranty period. Buyers shall prepay transportation charges for equipment returned to Anritsu for warranty repairs. Obligation is limited to the original purchaser. Anritsu is not liable for consequential damages.

LIMITATION OF WARRANTY

The foregoing warranty does not apply to Anritsu connectors that have failed due to normal wear. Also, the warranty does not apply to defects resulting from improper or inadequate maintenance, unauthorized modification or misuse, or operation outside of the environmental specifications of the product. No other warranty is expressed or implied, and the remedies provided herein are the Buyer's sole and exclusive remedies.

DISCLAIMER OF WARRANTY

DISCLAIMER OF WARRANTIES. TO THE MAXIMUM EXTENT PERMITTED BY APPLICABLE LAW, ANRITSU COMPANY AND ITS SUPPLIERS DISCLAIM ALL WARRANTIES, EITHER EXPRESSED OR IMPLIED, INCLUDING, BUT NOT LIMITED TO, IMPLIED WARRANTIES OF MERCHANTABILITY AND FITNESS FOR A PARTICULAR PURPOSE, WITH REGARD TO THE PRODUCT. THE USER ASSUMES THE ENTIRE RISK OF USING THE PRODUCT. ANY LIABILITY OF PROVIDER OR MANUFACTURER WILL BE LIMITED EXCLUSIVELY TO PRODUCT REPLACEMENT.

NO LIABILITY FOR CONSEQUENTIAL DAMAGES. TO THE MAXIMUM EXTENT PERMITTED BY APPLICABLE LAW, IN NO EVENT SHALL ANRITSU COMPANY OR ITS SUPPLIERS BE LIABLE FOR ANY SPECIAL, INCIDENTAL, INDIRECT, OR CONSEQUENTIAL DAMAGES WHATSOEVER (INCLUDING, WITHOUT LIMITATION, DAMAGES FOR LOSS OF BUSINESS PROFITS, BUSINESS INTERRUPTION, LOSS OF BUSINESS INFORMATION, OR ANY OTHER PECUNIARY LOSS) ARISING OUT OF THE USE OF OR INABILITY TO USE THE PRODUCT, EVEN IF ANRITSU COMPANY HAS BEEN ADVISED OF THE POSSIBILITY OF SUCH DAMAGES. BECAUSE SOME STATES AND JURISDICTIONS DO NOT ALLOW THE EXCLUSION OR LIMITATION OF LIABILITY FOR CONSEQUENTIAL OR INCIDENTAL DAMAGES, THE ABOVE LIMITATION MAY NOT APPLY TO YOU.

TRADEMARK ACKNOWLEDGMENTS

The *Bluetooth* word mark and logos are owned by the Bluetooth SIG, Inc. and any use of such marks by Anritsu is under license. Other trade marks and trade names are those of their respective owners.

Windows XP and Windows Vista are registered trademarks of Microsoft Corporation. Adobe Acrobat and Acrobat Reader are trademarks of Adobe Systems Incorporated.

NOTICE

Anritsu Company has prepared this manual for use by Anritsu Company personnel and customers as a guide for the proper installation, operation and maintenance of Anritsu Company equipment and computer programs. The drawings, specifications, and information contained herein are the property of Anritsu Company, and any unauthorized use or disclosure of these drawings, specifications, and information is prohibited; they shall not be reproduced, copied, or used in whole or in part as the basis for manufacture or sale of the equipment or software programs without the prior written consent of Anritsu Company.

UPDATES

Updates, if any, can be downloaded from the Documents area of the Anritsu Website at:
<http://www.anritsu.com>

For the latest service and sales contact information in your area, please visit:
<http://www.anritsu.com/contact.asp>

CE Conformity Marking

Anritsu affixes the CE Conformity marking onto its conforming products in accordance with Council Directives of The Council Of The European Communities in order to indicate that these products conform to the EMC and LVD directive of the European Union (EU).



C-tick Conformity Marking

Anritsu affixes the C-tick marking onto its conforming products in accordance with the electromagnetic compliance regulations of Australia and New Zealand in order to indicate that these products conform to the EMC regulations of Australia and New Zealand.



Notes On Export Management

This product and its manuals may require an Export License or approval by the government of the product country of origin for re-export from your country.

Before you export this product or any of its manuals, please contact Anritsu Company to confirm whether or not these items are export-controlled.

When disposing of export-controlled items, the products and manuals need to be broken or shredded to such a degree that they cannot be unlawfully used for military purposes.

Mercury Notification

This product uses an LCD backlight lamp that contains mercury. Disposal may be regulated due to environmental considerations. Please contact your local authorities or, within the United States, the Electronics Industries Alliance (www.eiae.org) for disposal or recycling information.

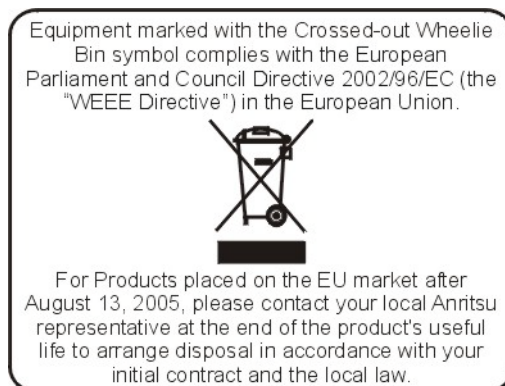

产品中有毒有害物质或元素的名称及含量

For Chinese Customers Only YLYB

部件名称	有毒有害物质或元素					
	铅 (Pb)	汞 (Hg)	镉 (Cd)	六价铬 [Cr(VI)]	多溴联苯 (PBB)	多溴二苯醚 (PBDE)
印刷线路板 (PCA)	×	○	×	×	○	○
机壳、支架 (Chassis)	×	○	×	×	○	○
LCD	×	×	×	×	○	○
其他(电缆、风扇、 连接器等) (Appended goods)	×	○	×	×	○	○
○：表示该有毒有害物质在该部件所有均质材料中的含量均在 SJ/T11363-2006 标准规定的限量要求以下。 ×：表示该有毒有害物质至少在该部件的某一均质材料中的含量超出 SJ/T11363-2006 标准规定的限量要求。						

环保使用期限



这个标记是根据 2006/2/28 公布的「电子信息产品污染控制管理办法」以及 SJ/T 11364-2006 「电子信息产品污染控制标识要求」的规定，适用于在中国销售的电子信息产品的环保使用期限。仅限于在遵守该产品的安全规范及使用注意事项的基础上，从生产日起算的该年限内，不会因产品所含有害物质的泄漏或突发性变异，而对环境污染，人身及财产产生深刻地影响。

注) 电池的环保使用期限是 5 年。生产日期标于产品序号的前四码 (如 S/N 0728XXXX 为 07 年第 28 周生产)。

DECLARATION OF CONFORMITY

Manufacturer's Name: ANRITSU COMPANY

Manufacturer's Address: Microwave Measurements Division
490 Jarvis Drive
Morgan Hill, CA 95037-2809
USA

declares that the product specified below:

Product Name: Power Meter

Model Number: ML2437A, ML2438A

conforms to the requirement of:

EMC Directive: 2004/108/EC
Low Voltage Directive: 2006/95/EC

Electromagnetic Compatibility: EN61326-1:2006

Emissions: EN55011:2009+A1:2010 Group 1 Class A

Immunity:	EN 61000-4-2:2009	4 kV CD, 8 kV AD
	EN 61000-4-3:2006 +A2:2010	3 V/m
	EN 61000-4-4:2004	0.5 kV S-L, 1 kV P-L
	EN 61000-4-5:2006	0.5 kV L-L, 1 kV L-E
	EN 61000-4-6: 2009	3 V
	EN 61000-4-11: 2004	100% @ 20 ms

Electrical Safety Requirement:

Product Safety: EN 61010-1:2010

Morgan Hill, CA

Eric McLean, Corporate Quality Director

Jul 7/10/12
Date

European Contact: For Anritsu product EMC & LVD information, contact Anritsu LTD, Rutherford Close, Stevenage Herts, SG1 2EF UK, (FAX 44-1438-740202)

Safety Symbols

To prevent the risk of personal injury or loss related to equipment malfunction, Anritsu Company uses the following symbols to indicate safety-related information. For your own safety, please read the information carefully *before* operating the equipment.

Symbols Used in Manuals

Danger



This indicates a risk from a very dangerous condition or procedure that could result in serious injury or death and possible loss related to equipment malfunction. Follow all precautions and procedures to minimize this risk.

Warning



This indicates a risk from a hazardous condition or procedure that could result in light-to-severe injury or loss related to equipment malfunction. Follow all precautions and procedures to minimize this risk.

Caution



This indicates a risk from a hazardous procedure that could result in loss related to equipment malfunction. Follow all precautions and procedures to minimize this risk.

Safety Symbols Used on Equipment and in Manuals

The following safety symbols are used inside or on the equipment near operation locations to provide information about safety items and operation precautions. Ensure that you clearly understand the meanings of the symbols and take the necessary precautions *before* operating the equipment. Some or all of the following five symbols may or may not be used on all Anritsu equipment. In addition, there may be other labels attached to products that are not shown in the diagrams in this manual.



This indicates a prohibited operation. The prohibited operation is indicated symbolically in or near the barred circle.



This indicates a compulsory safety precaution. The required operation is indicated symbolically in or near the circle.



This indicates a warning or caution. The contents are indicated symbolically in or near the triangle.



This indicates a note. The contents are described in the box.



These indicate that the marked part should be recycled.

For Safety

Warning



Always refer to the operation manual when working near locations at which the alert mark, shown on the left, is attached. If the operation, etc., is performed without heeding the advice in the operation manual, there is a risk of personal injury. In addition, the equipment performance may be reduced. Moreover, this alert mark is sometimes used with other marks and descriptions indicating other dangers.

Warning

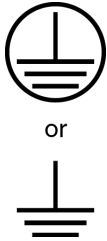

When supplying power to this equipment, connect the accessory 3-pin power cord to a 3-pin grounded power outlet. If a grounded 3-pin outlet is not available, use a conversion adapter and ground the green wire, or connect the frame ground on the rear panel of the equipment to ground. If power is supplied without grounding the equipment, there is a risk of receiving a severe or fatal electric shock.

Warning



This equipment can not be repaired by the operator. Do not attempt to remove the equipment covers or to disassemble internal components. Only qualified service technicians with a knowledge of electrical fire and shock hazards should service this equipment. There are high-voltage parts in this equipment presenting a risk of severe injury or fatal electric shock to untrained personnel. In addition, there is a risk of damage to precision components.

Caution



Electrostatic Discharge (ESD) can damage the highly sensitive circuits in the instrument. ESD is most likely to occur as test devices are being connected to, or disconnected from, the instrument's front and rear panel ports and connectors. You can protect the instrument and test devices by wearing a static-discharge wristband. Alternatively, you can ground yourself to discharge any static charge by touching the outer chassis of the grounded instrument before touching the instrument's front and rear panel ports and connectors. Avoid touching the test port center conductors unless you are properly grounded and have eliminated the possibility of static discharge.

Repair of damage that is found to be caused by electrostatic discharge is not covered under warranty.

Warning



This product is supplied with a rechargeable battery that could potentially leak hazardous compounds into the environment. These hazardous compounds present a risk of injury or loss due to exposure. Anritsu Company recommends removing the battery for long-term storage of the instrument and storing the battery in a leak-proof, plastic container. Follow the environmental storage requirements specified in the product technical data sheet.

Table of Contents

Chapter 1—General Information

1-1	About this Manual	1-1
1-2	Associated Documentation and Software.	1-1
1-3	Identification Number	1-1
1-4	Available Models.	1-1
1-5	Available Options, Accessories, and Power Sensors.	1-2

Chapter 2—Installation

2-1	Initial Inspection	2-1
2-2	Sensor Handling	2-1
2-3	Power Requirements	2-1
	AC Line Power.	2-1
	DC Power	2-1
	Battery Power	2-2
	Fuses.	2-2
	Grounding	2-2
2-4	Environmental Requirements	2-2
2-5	Rack Mounting	2-3
2-6	Battery Charging, Removal and Replacement	2-3
2-7	Storage and Shipment	2-5
	Preparation for Storage	2-5
	Environmental Requirements	2-5
2-8	Preparing for Shipment.	2-5

Chapter 3—Memory and Security Considerations

3-1	Introduction	3-1
	Internal Flash Memory (8 MB EEPROM)	3-1
	RAM Memory used by the DSP microcomputer (640 KB).	3-1
	RAM Memory as non-volatile RAM (1 MB)	3-1
3-2	Secure Mode	3-1
3-3	Clearing the Non-Volatile Static RAM.	3-2
3-4	Anritsu Power Sensors EEPROM.	3-2
	EEPROM Contents	3-2

Table of Contents (Continued)

Chapter 4—Connections

4-1	Front Panel Connectors	4-1
	Calibrator Connector	4-1
	Sensor A Connector	4-1
	Sensor B Connector (ML2438A only)	4-2
4-2	Rear Panel Connectors.	4-2

Chapter 5—Front Panel Operation

5-1	Front Panel Controls	5-2
5-2	Power-On Procedure	5-3
5-3	Sensor Menu.	5-5
	Setup	5-5
	Calfactor	5-6
	Averaging	5-9
	Offset	5-11
	Duty cycle	5-12
	Rng Hold [RGH].	5-12
5-4	Channel Menu	5-13
	Setup	5-13
	Rel 1 [REL]	5-14
	Rel 2 [REL]	5-14
	Limits	5-14
5-5	Trigger Menu	5-16
	Setup	5-17
5-6	System Menu	5-22
	Setup	5-22
	Profile	5-23
	Power vs. Time	5-24
	Source Sweep	5-25
	Control	5-26
	Display	5-30
	Sound	5-31
	Print [PRINT]	5-32
	Battery	5-32
	Rear Panel	5-33
	Graphics	5-36
	Secure [SECURE]	5-37
	Identity [*IDN, OI]	5-37

Table of Contents (Continued)

5-7	Cal/Zero Menu	5-38
	Zero/Cal	5-38
	Cal 0 dBm [CAL]	5-38
	Zero [ZERO]	5-38
	RF ON/OFF [RFCAL]	5-38
	Ext V [VZERO]	5-38

Chapter 6—Procedures

6-1	Power Measurement	6-1
6-2	Zeroing the Sensor	6-1
6-3	Sensor Calibration	6-2
6-4	Sensor Zero/Cal	6-2
6-5	Performance Verification	6-3
6-6	Printer Connection	6-3
6-7	GPIB Remote Operation	6-3
6-8	Serial Remote Operation	6-4
6-9	RS232 Modem Support	6-5
6-10	Profile Operation Mode	6-10
	Typical Setup	6-10
	Scaling	6-11
	Cursor Readout	6-11
	Triggered Measurements	6-12
	Control of x-axis - Width of Profile - Sample Time	6-13
	Advanced Triggering and Setup Options	6-14
6-11	Source Sweep Mode	6-15
	Frequency Sweep Mode	6-15
	Power Sweep Mode	6-15
	Source Sweep Graph	6-16
	Using an Anritsu Synthesizer	6-16
6-12	Power vs. Time Mode	6-17
6-13	User Cal Factors	6-17
	Example Procedure	6-18
	Readout Mode	6-18
6-14	Optimizing Readings	6-19
	DISP ON/OFF command	6-20
	FAST ON/OFF command	6-21
	Using Buffered Requests	6-21
	Changing Measurement Modes	6-22
	An Example Program in C	6-23
6-15	Operator Maintenance	6-24
	Software Loader Instructions	6-24

Table of Contents (Continued)

Chapter 7—Measurement Examples

7-1	Example 1: Standard CW Power Measurements	7-1
7-2	Example 2: Measuring Modulated Carrier	7-8
7-3	Example 3: Optimizing Measurements at Low Power Levels	7-9
7-4	Example 4: Using Both Channels	7-11
7-5	Example 5: Using Two Sensors	7-13
7-6	Example 6: Gain Compression Measurement	7-15
7-7	Example 7: Measuring Pulse Signals With a Duty Cycle	7-17
7-8	Example 8: Profiling Pulse Signals	7-19
7-9	Example 9: Displaying GSM-TDMA Bursts	7-23
7-10	Example 10: Power Versus Time Data Logging	7-27
7-11	Example 11: Frequency Measurements Using a Separate Source	7-31

Chapter 8—GPIB Operation

8-1	Data I/O Formats	8-1
	<NR1>	8-2
	<NR2>	8-2
	<NR3>	8-3
	<NRf>	8-3
	<String>	8-3
	<Arbitrary ASCII>	8-3
	<Arbitrary Block>	8-3
8-2	Query Commands	8-4
8-3	GPIB PC Card Setup	8-4
	GPIB Device Template	8-4
	GPIB Card Settings	8-4
8-4	Using 488.1 GPIB	8-5
	Device Clear (DCL) and Selected Device Clear (SDC)	8-5
	Device trigger (GET)	8-5
	Goto local (GTL)	8-5
	Interface clear (IFC)	8-5
	Local lockout (LLO)	8-5
	Serial poll	8-5
8-5	Using 488.2 GPIB	8-6

Table of Contents (Continued)

8-6	488.2 Command Format	8-6
	Status Byte	8-6
	Event Status Bit (ESB)	8-6
	Message Available Bit (MAV)	8-7
	Getting a Reading	8-8
	Service Request Status (SRQ)	8-8
	RGH	8-8
	LIM	8-8
	MAV	8-8
	ESB	8-8
8-7	Functional Groups	8-9
	BNC	8-9
	Calibration	8-9
	Channel	8-9
	Data Output	8-9
	Display	8-9
	GPIB 488.2	8-9
	GPIB Setup	8-9
	GPIB Trigger	8-9
	Profile Setup	8-10
	Sensor	8-10
	System	8-10
	Trigger	8-10

Table of Contents (Continued)

8-8	ML24xxA Native Commands	8-11
	*CLS (Clear GPIB status bytes)	8-11
	*ESE (Event Status byte Enable)	8-12
	*ESE? (Return Event status register enable mask)	8-14
	*ESR? Event status register request	8-14
	*IDN? (Request device identification)	8-14
	*OPC (Operations complete)	8-14
	*OPC? (Operations complete Output '1')	8-14
	*RCL (Recall a stored setup)	8-15
	*RST (Reset Device)	8-15
	*SAV (Save configuration)	8-15
	*SRE (Setup service request enable register)	8-15
	*SRE? (Return Service Request Enable register)	8-16
	*STB? (Return Status Byte register)	8-16
	*TRG (Perform the GPIB 'Group Execute Trigger' command)	8-16
	*TST? (Self Test)	8-16
	ADDR (Change GPIB address)	8-17
	AVG (Sets up averaging for a sensor)	8-18
	AVGLL (Auto low level averaging)	8-19
	AVGM (Manual Averaging)	8-19
	BAUTS (Battery Auto Turn OFF)	8-20
	BAUTT (Battery Auto shut off after x minutes)	8-20
	BUFF (GPIB response buffering enabled)	8-20
	CAL (Cal sensor to 0 dBm reference)	8-21
	CFADJ (Cal Adjust)	8-21
	CFCAL (Cal factor manual setting)	8-21
	CFFRQ (Cal Factor Frequency value)	8-22
	CFSRC (Cal factor source)	8-22
	CFUADD (Add an entry pair to a cal factor table)	8-23
	CFUCT (Clear cal factor table)	8-23
	CFUID (Cal factor table identity update)	8-24
	CFUNITS (Cal factor display units)	8-24
	CFULD (Cal factor table binary load)	8-24
	CFUPT (Preset cal factor table)	8-25
	CFURD (Cal factor table binary read)	8-25
	CFUSAV (Cal factor table save)	8-25
	CFUSEL (Select cal factor table)	8-26
	CFUTBL (Number of cal factor tables in the sensor)	8-26
	CFUUSE (Number of cal factor table being used)	8-26
	CFUULD (Valid cal factor table check)	8-26
	CFVAL Current cal factor value	8-27
	CHCFG (Channel input configuration)	8-27
	CHRES (Set channel decimal pint resolution)	8-28

Table of Contents (Continued)

CHUNIT (Set Channel units)	8-28
CONT (Continue)	8-28
CUR (Cursor in Power vs. Time and Source Sweep modes)	8-29
CURLK (Link cursors in all graphic modes).	8-29
CVSPF (V/GHz calibration factor stop frequency).	8-30
CVSPV (V/GHz calibration factor stop voltage).	8-30
CVSTF (V/GHz calibration factor start frequency).	8-30
CVSTV (V/GHz calibration factor start voltage).	8-31
DBLGHT (Battery LCD Back light mode)	8-31
DBLTIM (Auto Backlight OFF timer setting)	8-31
DCONT (Set Display Contrast)	8-32
DCONTD (Set display contrast down by one)	8-32
DCONTU (Set display contrast up by one)	8-32
DISP (Display On or OFF).	8-32
DTRGD (Display Trigger Delay)	8-33
DUTY (Duty cycle).	8-34
DUTYS (Duty cycle state)	8-34
EMUL (GPIB emulation mode)	8-35
ENTERR (Entry Error beep)	8-35
ERRLST (Returns the DDE error list)	8-36
FAST (Operate in non-488.2 compliant mode)	8-37
FHOLD (Fail indicator Hold)	8-38
FRST (Factory Reset)	8-39
GMNMX (Return the minimum and maximum values)	8-39
GPRST (Reset min/max graph).	8-40
GRAUTO (Auto scaling)	8-40
GRAVG (Average between profile cursors).	8-40
GRCP (Connect points on profile).	8-40
GRDATA (Display Graph Cursor Data).	8-41
GRDDT (Power vs. Time data display time)	8-41
GRDRQ (Return Graph Data readout)	8-42
GRFS (Profile Reference line state)	8-42
GRMD (Profile, Power vs. Time and Source Sweep Selection)	8-42
GRPIX (Profile type)	8-43
GRPRD (Profile data collection period).	8-43
GRPTP (Graph Pretrigger Percentage).	8-43
GRSWP (Graph Averaging Number for Profile or Source Sweep)	8-44
GRSWR (Reset Graph Averaging for Profile or Source Sweep)	8-44
GRSWS (Graph Average State for Profile or Source Sweep)	8-44
GRTMM (Profile Min/Max tracking mode)	8-45
GRYB (Set graph Y-axis bottom scale)	8-45
GRYT (Set graph Y-axis top scale)	8-45

Table of Contents (Continued)

GT0 (Set to ignore the Group Execute Trigger (GET) command) . . .	8-46
GT1 (Set 'GET' command to TR1 type (immediate) trigger)	8-46
GT2 (Set 'GET' command to TR2 type (settling delay) trigger)	8-46
GTARM (Set profile trigger arming)	8-46
GTDLY (Set profile trigger sample delay)	8-47
GTGW (Set profile trigger gate width)	8-47
GTLVL (Set profile trigger level)	8-47
GTSRC (Set Profile Trigger source)	8-48
GTTYP (Set profile trigger type)	8-48
GTXTTL (Set profile external trigger edge)	8-49
HLIM (Set High limits)	8-49
HLIMS (Turn on/off High limits)	8-50
HOLD (Graph hold)	8-50
IBBLP (Blanking active TTL level)	8-50
KEYCK (Turn key click sound on or off)	8-51
LINK (Trigger linking)	8-51
LLIMS (Turn on/off low limits)	8-52
MMRST (Min Max Tracking reset)	8-53
MNGDB (Output Min Graph Binary Data)	8-53
MNGD (Output Min Graph Data)	8-53
MNMXS (Track min and max values)	8-54
MODDEL (Modem redial delay time)	8-54
MODINIT (Initialize modem)	8-54
MODLIM (Autodial enable for limits failure)	8-54
MODPH (Autodial phone number)	8-55
MODPWR (Autodial enable for power on)	8-55
MODRED (Redial count)	8-55
MODRNG (Autodial enable for range error)	8-56
MXGDB (Output Max Graph Binary Data)	8-56
MXGD (Output Max Graph Data)	8-56
O (Return display channel reading)	8-57
OBACM (AC mod output polarity configuration)	8-57
OBCH (BNC output port channel configuration)	8-57
OBDSP (BNC analog output display stop value)	8-58
OB DST (BNC analog out display start value)	8-58
OBMD (BNC output mode select)	8-59
OBPL (BNC pass/fail pass level)	8-59
OBVSP (BNC analog output stop voltage scale)	8-60
OBVST (BNC analog output start voltage scale)	8-60
OBZL (BNC RF blanking output level when zeroing)	8-60
OFFCLR (Clear an offset table)	8-60
OFFFIX Offset fixed value	8-61

Table of Contents (Continued)

OFFTBL (Specify the table used to apply offsets to the sensor)	8-61
OFFTBU (Updates an offset table)	8-62
OFFTYP (Offset type to use)	8-63
OFFVAL (Sensor Offset Value)	8-63
OGBD (Output Graph Binary Data)	8-63
OGD (Output Graph Data)	8-64
OGSD (Output Valid Samples Array (Power vs. Time mode only)) . .	8-64
OI (Output device identification)	8-64
ON (Output number of channel readings)	8-65
OPMD (ML243xA operation mode)	8-65
PRINT (Send details to the connected printer.)	8-66
PRNSEL (Select the type of printer)	8-66
RCD (Range Calibrator data request)	8-66
REL (Relative control)	8-67
RFCAL (Turn RF reference calibrator ON or OFF)	8-67
RGH (Range Hold Sensor)	8-67
RSBAUD (RS232 Baud Rate)	8-68
RSMODE (RS232 Operating Mode)	8-68
SECURE (Secure system state)	8-68
SENMM (Sensor Measurement mode)	8-69
SENMO (Universal Sensor Operation Mode)	8-69
SENSTL (Set Sensor Settle Percentage)	8-70
SENTYP (Return sensor information)	8-70
SRCMOD (Source Sweep Mode)	8-70
SRCSPFRQ (Source Sweep Stop Frequency)	8-70
SRCSPWR (Source Sweep Stop Power)	8-71
SRCSTAT (Source Sweep mode status request)	8-71
SRCSTFRQ (Source Sweep Start Frequency)	8-71
SRCSTPWR (Source Sweep Start Power)	8-71
START (Initial startup self test command)	8-72
STATUS (Status Message)	8-73
STERR (Returns results of POST or *TST?)	8-75
SYSLD (Load saved setup store over the GPIB)	8-75
SYSLNM (Saved set naming)	8-76
SYSRD (Output the saved setup over the GPIB)	8-76
TEXT (User text command)	8-77
TEXTS (User text display command)	8-77
TR0 (Trigger hold mode)	8-77
TR1 (Trigger immediate)	8-78
TR2 (Trigger with a settling delay)	8-78
TR3 Trigger free run	8-79
TRGARM (Trigger arming)	8-79

Table of Contents (Continued)

	TRGDLY (Trigger sample delay)	8-80
	TRGGW (Set trigger gate width)	8-80
	TRGLVL (Set trigger level)	8-81
	TRGMODE (Change trigger mode)	8-81
	TRGSRC (Set trigger source)	8-82
	TRGTYP (Set Trigger type)	8-82
	TRGXTTL (Set external trigger edge type)	8-83
	VZERO (Zero the BNC input connector)	8-83
	ZERO (Zero the selected sensor)	8-83
8-9	GPIB Emulation Modes.	8-84
	Zeroing a Sensor	8-84
	Sensor Ranges	8-84
	Output Format	8-84

Table of Contents (Continued)

8-10 ML4803A Emulation Commands	8-85
SRQs	8-85
Status Byte	8-85
Output Requests	8-86
Unsupported Commands	8-86
AVE (Sensor averaging setting)	8-87
CAL (Set the user cal factor value)	8-87
CCA (Clear the calfactor value to zero)	8-87
CDJ (Perform a CAL 0 dBm)	8-87
COF (Clear the offset value to zero)	8-87
COS (Turn ON the 50 MHz, 0 dBm RF calibrator output)	8-87
CRF (Clear the reference value to zero)	8-87
CST (Turn OFF the 50 MHz, 0 dBm RF calibrator output)	8-87
DBM (Sets the display channel units to dBm)	8-88
DBR (Sets display channel units to dB's and takes the relative value)	8-88
EMUL (GPIB emulation mod)	8-88
MCA (Set the cal factor value at the specified memory location in dBm)	8-88
MCC (Clears the cal factor value at the specified memory location)	8-89
MCO (Clears the offset value at the specified memory location)	8-89
MCQ (Clears the frequency value at the specified memory location)	8-89
MCR (Clears the reference value at the specified memory location)	8-89
MCT (Clears all the entries at the specified memory location)	8-89
MDI (Disable memory store setting and use)	8-89
MEN (Enable setting of the memory stores)	8-89
MFG (Set the frequency value at the specified location in GHz)	8-90
MFM (Set the frequency value at the specified location in MHz)	8-90
MOF (Set the offset value at the specified location in dBm)	8-90
MRF (Set the reference value at the specified location in dBm)	8-90
ODT (Output the current calibration factor, offset, and reference level)	8-91
OFF (Set sensor offset value)	8-91
OI? (Request identity)	8-91
OMR (Output a memory store set of data)	8-92
OPW (Request for channel reading)	8-92
REF (Set the reference value)	8-95
RNG (Sensor measurement range hold)	8-95
SRQ (Turns on or off the SRQ on output data ready)	8-95
STA (Restart averaging reading)	8-95
WAT (Sets the display channel units to Watts)	8-95
ZAJ (Zero the sensor)	8-96

Table of Contents (Continued)

8-11	HP436A Emulation Commands	8-97
	+ (Disable cal factor)	8-97
	– (Enable cal factor)	8-97
	1, 2, 3, 4, & 5 (Set sensor operating range)	8-97
	9 (Auto range)	8-97
	A (Wat)	8-97
	B (dB (rel))	8-98
	C (dB (ref))	8-98
	D (dB)	8-98
	EMUL (Select emulation mod)	8-98
	H (Hold mod)	8-99
	I (Trigger without settling)	8-99
	OI (Identificatio)	8-99
	R (Free run mod)	8-99
	T (Trigger with settling)	8-99
	V (Free run mode with settling)	8-99
	Z (Zero sensor)	8-100
	Output Format	8-100

Table of Contents (Continued)

8-12	HP437B Emulation Commands	8-102
	*CLS (Clear GPIB status byte)	8-103
	*ESE (Set the Event Status register enable mask)	8-103
	*ESE? (Return Event status register enable mask)	8-105
	*ESR? (Event status register request)	8-105
	*RST (Reset Device)	8-105
	*SRE (Setup service request enable register)	8-105
	*SRE? (Return Service Request Enable register)	8-105
	*STB? (Return Status Byte register)	8-106
	*TST? (Self Test)	8-106
	@1 (Set SRE mask)	8-106
	CL (Cal Adjust)	8-107
	CS (Clear all status byte)	8-107
	CT (Clear the cal factor table)	8-107
	DA (Display All)	8-107
	DC (Duty Cycle state)	8-108
	DD (Display disable)	8-108
	DE (Display enable)	8-108
	DF (Display disable)	8-108
	DR (Set GPIB address)	8-108
	DY (Duty Cycle)	8-109
	EMUL (GPIB emulation mode)	8-109
	EN (Enter command)	8-110
	EX (Exit cal factor table mode)	8-110
	FA (Auto average)	8-110
	FH (average hold)	8-111
	FM (Set average value)	8-111
	FR (Frequency of the input signal)	8-111
	GT (Set group trigger)	8-112
	ID (Return identification string)	8-112
	IDN? (HP437B identity request)	8-112
	KB (Calibration factor)	8-113
	LG (Set log units)	8-113
	LH (Set high limit)	8-113
	LL (Set low limit)	8-113
	LM (limits check state)	8-114
	LN (Set linear units)	8-114
	OC (Set calibrator state)	8-114
	OD (Output the display)	8-114
	OF (Offset state)	8-115
	OI (Return identification string)	8-115
	OS (Set offset value)	8-115

Table of Contents (Continued)

PR (Preset the unit)	8-115
RA (Auto Range)	8-115
RC (Recall setup)	8-116
RE (Set decimal point resolution)	8-116
RF (Set the reference cal factor value for a table)	8-116
RH (Range hold)	8-116
RL (Relative mode)	8-117
RM (Range hold set)	8-117
RV (Service request mask value)	8-117
SE (Select cal factor table)	8-117
SM (status message)	8-118
ST (Store setup)	8-119
SV (Save cal factor table)	8-119
TR0 (Trigger hold mode)	8-119
TR1 (Trigger immediate)	8-120
TR2 (Trigger with a settling delay)	8-120
TR3 (Trigger free run)	8-120
ZE (Zero sensors)	8-120

Table of Contents (Continued)

8-13	HP438A Emulation Commands	8-121
	?ID (HP Identity request)	8-122
	@1 (Set SRE mask)	8-122
	AD (Set display to A – B)	8-122
	AP (Set single sensor A display)	8-122
	AR (Set display A / B)	8-122
	BD (Set display B – A)	8-122
	BP (Set single sensor B display)	8-123
	BR (Set display B / A)	8-123
	CL (Cal Adjust)	8-123
	CS (Clear all status bytes)	8-123
	DA (Display All)	8-123
	DD (Display disable)	8-123
	DE (Display enable)	8-124
	DR (Set GPIB address)	8-124
	EMUL (GPIB emulation mode)	8-124
	FA (auto average)	8-124
	FH (average hold)	8-125
	FM (Set average value)	8-125
	GT (Set group trigger)	8-125
	KB (Calibration factor)	8-126
	LG (Set log units)	8-126
	LH (Set high limit)	8-126
	LL (Set low limit)	8-126
	LM (limits check state)	8-126
	LN (Set linear units)	8-127
	OC (Set calibrator state)	8-127
	OI (HP Identity request)	8-127
	OS (Set offset value)	8-127
	PR (Preset the unit)	8-128
	RA (Auto Range)	8-128
	RC (Recall setup)	8-128
	RH (Range hold)	8-128
	RL (Relative mode)	8-129
	RM (Range hold set)	8-129
	RV (Service request mask value)	8-129
	SM (Status Message)	8-130
	ST (Store setup)	8-130
	TR0 (Trigger hold mode)	8-131
	TR1 (Trigger immediate)	8-131
	TR2 (Trigger with a settling delay)	8-131
	TR3 (Trigger free run)	8-131
	ZE (Zero sensors)	8-131

Table of Contents (Continued)

8-14	Programming Examples	8-132
	Output Data	8-132
	Get Graph Data	8-133
	Status Register Control	8-134
	488.2 General Send/Receive System	8-134
	Binary Output Message Decoding	8-136

Appendix A—Technical Support

A-1	Getting Support	A-1
-----	-----------------	-----

Appendix B—Specifications

B-1	System Configuration	B-1
B-2	System Defaults	B-3
B-3	System Error Messages	B-10
B-4	Calibration and Zero Error Codes	B-12

Appendix C—GPIB Quick Reference

C-1	ML24XXA Quick Reference	C-1
	BNC Functional Group Commands	C-1
	Calibration Functional Group Commands	C-1
	Channel Functional Group Commands	C-1
	Data Output Functional Group Commands	C-2
	Display Functional Group Commands	C-3
	GPIB 488.2 Functional Group Commands	C-3
	GPIB Setup Functional Group Commands	C-3
	GPIB Trigger Functional Group Commands	C-4
	Profile Setup Functional Group Commands	C-4
	Sensor Functional Group Commands	C-5
	System Functional Group Commands	C-6
	Trigger Functional Group Commands	C-7
	ML24XXA Native Mode Query Commands	C-8
C-2	ML4803A Quick Reference	C-12
	ML4803A Emulation Mode Commands	C-12
C-3	HP436A Quick Reference	C-14
	HP436A Emulation Mode Commands	C-14
C-4	HP437B Quick Reference	C-15
	HP437B Emulation Commands	C-15
C-5	HP438A Quick Reference	C-16
	HP438A Emulation Commands	C-16
C-6	HP-IB Support	C-18
	HP437B Commands	C-18
	HP438A Commands	C-21

Table of Contents (Continued)

Appendix D—Connector Care and Handling

D-1	Pin Depth Mating Connectors	D-1
D-2	Torquing Connectors	D-2
D-3	Mechanical Shock	D-2
D-4	Cleaning Connectors	D-3

Table of Contents (Continued)

Chapter 1 — General Information

1-1 About this Manual

This manual provides installation and operational information for the ML2437A and ML2438A Power Meters. All explanations in this manual apply equally to both units unless otherwise stated. For simplicity, the term “ML243xA” is used to refer to both units.

1-2 Associated Documentation and Software

In addition to this manual, the following items are also available on the product disc shipped with the power meter:

- Power Meters & Power Sensors Technical Data Sheet and Product Brochure
- PowerSuite Software and Quick Start Guide: PowerSuite is a PC application designed to demonstrate the features and capabilities of the ML2437A/38A that are available when interfacing to the device via a GPIB card or RS232 Serial port. PowerSuite is written in Visual Basic 6.0 and the source code, included in the directory, can be used or adapted to add extra features as required.
- Performance Verification and Uncertainty Spreadsheets

Updated software and related literature can be downloaded from the product page Library tab:

<http://www.anritsu.com/en-us/products-solutions/products/ml2437a.aspx>

<http://www.anritsu.com/en-us/products-solutions/products/ml2438a.aspx>

1-3 Identification Number

The ML243xA ID number is affixed to the rear panel. Please use the complete ID number when ordering parts or corresponding with the Anritsu Customer Service department.

1-4 Available Models

The following ML243xA Power Meters are available with either one or two sensor inputs and are delivered with a 1.5 m sensor cable for each input.

Table 1-1. Model Numbers and Sensor Channels

Model Number	Number of Sensor Channels
ML2437A	Single Channel
ML2438A	Dual Channel

Note	The use of sensor cables greater than 10 meters in length is not recommended when measuring pulses of less than 10 ms.
-------------	--

1-5 Available Options, Accessories, and Power Sensors

Refer to the Anritsu *Power Meters & Power Sensors Technical Data Sheet*, PN: 11410-00423 for a complete listing of additional options and accessories, including power sensors available for the ML243xA power meters.

Chapter 2 — Installation

2-1 Initial Inspection

Inspect the shipping container for damage. If the container or cushioning material is damaged, retain until the contents of the shipment have been checked against the packing list and the instrument has been checked for mechanical and electrical operation. If the power meter is damaged mechanically, notify your local sales representative or Anritsu Customer Service Center. If either the shipping container is damaged or the cushioning material shows signs of stress, notify the carrier as well as Anritsu. Retain the shipping materials for the carrier's inspection.

2-2 Sensor Handling

The sensors are enclosed in a polycarbonate case to help prevent damage. The sensor connectors, however, are exposed and are a critical part of the microwave instrument. Refer to the MA24xxA Series Power Sensor manual (10585-00004) for detailed information on proper connector care.

2-3 Power Requirements

The ML243xA Power Meter can be operated from either AC line power, external DC power, or from the optional internal battery. The ML243xA Power Meter is intended as an Installation (Overvoltage) Category II, Insulation Category I device. At power-on, the power meter will perform a brief power-on self test (POST). If a POST error occurs, information and available options are displayed on the screen. If the POST is successful, the instrument loads the last used configuration, unless Secure mode has been selected.

AC Line Power

The ML243xA Power Meter can operate on AC input power of 85-264 V, 47-440 Hz, 40 VA maximum. The power meter automatically configures itself for the voltage applied. The AC line input is protected by an internal fuse.

DC Power

The ML243xA Power Meter can also operate from a nominal external 12-24 VDC input in the absence of AC line power. DC line power is protected by a fuse mounted inside the unit, on the main board. A grounding terminal is provided on the rear panel to ground the unit during operation from a DC supply.

Battery Power

The ML243xA Power Meter can be operated using the optional internal battery pack. During battery operation, an icon is displayed on measurement screens indicating the state of charge. When the remaining capacity reaches less than 10 %, the icon will flash, indicating that charging will soon be required. When running from battery power, an estimate of typical-use running time remaining can be viewed using the System menu. Note that, due to power consumption considerations, GPIB and serial remote operation are not available when the power meter is running from the battery.

The AUTO POWER OFF feature is also available through the System menu, and can be used to automatically switch the unit to standby after a specified period of inactivity to save battery power. The timer can be set for 10 to 240 minutes, and any key press will restart the timer. This same feature will automatically switch the unit to standby when the battery is fully discharged (in order to minimize the risk of over-discharge).

Note	The ML243xA Power Meter uses a high-capacity Ni-MH battery. Over-discharge can result in a permanent loss of battery capacity of as much as 20 %. If the unit is to be stored for an extended period (longer than one week), remove the optional battery pack so as to preclude over-discharge.
-------------	---

For optimum battery life, store the battery pack at -20 to +50 °C (-4 to +122 °F) for short periods and -20 to +35 °C (-4 to +95 °F) for long term storage. The ML243xA Power Meter will operate from AC or DC main power with this battery removed. This battery is not used for the retention of nonvolatile memory functions. Refer to Battery Charging, Removal and Replacement, for further information.

Fuses

The ML243xA Power Meter AC and DC input lines are protected by internally mounted fuses. These fuses should only be changed by qualified service personnel. Replace only with fuses of the same type and rating (AC fuse is 2 A, 250 V, slow-blow; DC fuse is 3 A, 125 V, slow-blow).

Grounding

The ML243xA Power Meter must be properly grounded. Failure to ground the instrument could be hazardous to operating personnel. The meter is supplied with a three-conductor power cord. The instrument is properly grounded during AC line operation when the plug is connected to a properly installed three-prong receptacle. A grounding terminal is provided on the rear panel to ground the unit during operation from a DC supply.

2-4 Environmental Requirements

The ML243xA Power Meter is designed to operate within the temperature range of 0 to 50 °C (32 to 122 °F) with a maximum humidity of 90 % at 40 °C (104 °F), non-condensing. Full accuracy is specified at 5 to 35 °C (23 to 95 °F). Although not recommended, operation in temperatures to -20 °C (-4 °F) is possible. At these temperatures the liquid crystal display may exhibit excessively slow response. The soft sided carry case (part number D41310) and optional front panel cover (PN: 2000-1535) can be used to help retain internally generated heat and may improve response.

2-5 Rack Mounting

The ML243xA can be ordered with rack mounting hardware that allows it to be mounted into a standard 48 cm equipment rack. There are two rack mount option kits available:

- The 2400-82 Rack Mount option allows the installation of a single ML243xA in either the left or right side rack position.
- The 2400-83 Rack Mount option allows side-by-side mounting of two ML243xA.

Refer to the instructions that come with the mounting kit for installation.

2-6 Battery Charging, Removal and Replacement

The optional ML243xA Power Meter battery is a 12 Volt, 3000 mA-h nickel-metal hydride (Ni-MH) multi-cell pack, located in a compartment on the bottom of the housing. The compartment cover is secured by fractional turn fasteners, as shown in the figure below. Rotate the fasteners approximately 1/4-turn counter-clockwise to release the cover.

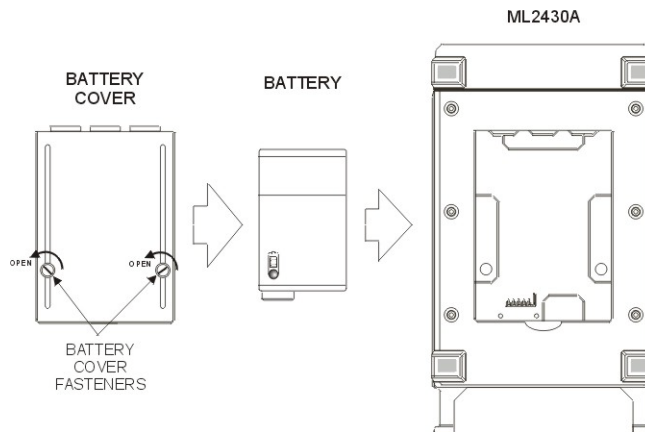

Figure 2-1. Battery Compartment

Note

The battery is shipped with a partial charge only, and should be fully charged before use.

The life of the battery (the number of useful charges and available operating time) can be extended by correct use. It is also possible to recover some of the performance of a battery after it has been used incorrectly.

1. A battery will be damaged if left inside a power meter when the power meter is not used for a period longer than two weeks. Do not leave a battery in a power meter if it is not being used.
2. Best charging of the battery is achieved by using the optional external battery charger.
3. It is not recommended for a battery to be charged with the power meter internal charger. However, the power meter can charge a well-maintained battery.
4. A battery should always be fully discharged before being re-charged. Fit the battery to the power meter and discharge the battery before charging. The battery charge level

may be checked by fitting the battery in the power meter and pressing the following front panel keys

- a. Press [System] > [more] > [more] > [Battery] > [STATUS].
 - b. The remaining capacity is shown as a percentage of full charge.
5. An acceptable level of charge is defined by the number of hours the power meter will operate with the charged battery. Typically this is 4.5 hours with the display backlight on, and 9 hours with the backlight off. The percentage of charge is a guide not a specification.
 6. The power meter can operate with two types of battery.
 - Duracell DR36 2800 mAh
 - Energizer NJ1020 3500 mAh

The NJ1020 has 25 % more capacity than the DR36.

For the DR36, 80 % of charge is approximately 4.5 hours operation (backlight on).

For the NJ1020, 66 % of charge is approximately 4.5 hours operation (backlight on).

7. If a battery repeatedly charges to less than 50 % it may be possible to recover some of the lost charge capability. This is achieved by completely discharging the battery and then recharging it 5 times. The best way to discharge the battery is to disable the auto off function so that the power meter will operate until automatically shut down.

Battery voltage. Press the following keys to set auto off to no:

- c. Press [System] > [more] > [more] > [Battery].
- d. Press [AUTO] to change the AUTO power off states to “Disable”.

Note

To avoid excessive heat build up, always remove the ML243xA from the optional soft-sided carrying case (D41310) before selecting fast charging.

The ideal battery temperature ranges are:

- Discharging: -20 to +50 °C (-4 to +122 °F)
- Charging: 10 to +45 °C (+50 to +113 °F)

Note that charging will be inhibited if the temperature falls outside these limits.

To remove the battery, first disconnect any AC or DC input line power. Open the battery compartment as illustrated and remove the battery. Replace the battery with an identical battery or with an equivalent as recommended by an Anritsu Service Center. Ensure that the battery is correctly connected and that the battery compartment cover is securely fastened.

Note that the battery is an optional component that is not used for the retention of non-volatile memory functions, and is not required for the power meter to operate from either AC or DC line sources. Serial and GPIB remote operation, however, are not available when the power meter is running from battery power.

Warning

This product is supplied with a rechargeable battery that could potentially leak hazardous compounds into the environment. These hazardous compounds present a risk of injury or loss due to exposure. Anritsu Company recommends removing the battery for long-term storage of the instrument and storing the battery in a leak-proof, plastic container. Follow the environmental storage requirements specified in the product technical data sheet.

The ML243xA battery pack can leak, explode, or catch on fire if it is opened, disassembled, or exposed to fire or very high temperatures. No attempt should be made to open, repair, or modify the battery package. When a battery pack has reached the end of its functional life, it should be returned to the nearest Anritsu Service Center for proper recycling or disposal. Do not treat a used battery as normal waste.

2-7 Storage and Shipment

The following paragraphs describe preparing the power meter for storage and shipment.

Preparation for Storage

Preparing the power meter for storage consists of cleaning the unit and packing it with moisture-absorbing desiccant crystals. Whenever the unit is to be stored for an extended period (longer than one week), it is advisable to remove the optional battery pack. Refer to Section 2-8, “Battery Charging, Removal and Replacement” for instructions.

Warning

This product is supplied with a rechargeable battery that could potentially leak hazardous compounds into the environment. These hazardous compounds present a risk of injury or loss due to exposure. Anritsu Company recommends removing the battery for long-term storage of the instrument and storing the battery in a leak-proof, plastic container. Follow the environmental storage requirements specified in the product technical data sheet and below.

Environmental Requirements

Store the unit in a temperature controlled environment that is maintained between -40 °C and +70 °C (-40 °F to +156 °F), with a maximum humidity of 90 % at 40 °C (104 °F), non-condensing. For optimum battery life, store the battery pack at -20 °C to +50 °C (-4 °F to +122 °F) for short periods and -20 °C to +35 °C (-4 °F to +95 °F) for long term storage.

2-8 Preparing for Shipment

Follow the procedure below if it is necessary to return the ML2437A/38A to Anritsu.

1. Wrap the ML243xA to protect the finish.
2. Position the ML243xA in the original shipping container.

Note	If the original shipping container is no longer available, use a strong corrugated cardboard container that is at least 15 cm larger than the ML243x8A.
-------------	---

3. Insert cushioning material between the ML243xA and the container. Pack the cushioning material tightly in place while taking care not to put pressure on the RF connector on the front panel.
4. Seal the container carefully; use shipping tape or an industrial stapler.
5. Return the container to the appropriate Anritsu service center. The address of your local service center can be found at <http://www.anritsu.com/Contact.asp>.

Chapter 3 — Memory and Security Considerations

3-1 Introduction

The ML2437A/38A Power Meters have three different types of memory devices:

Internal Flash Memory (8 MB EEPROM)

This memory space is used to store the instrument firmware for the main processor and DSP factory calibration. Also stored in this memory is the model number and serial number. During a firmware update, the old firmware is erased. The firmware does not contain any user information or any variables generated during the execution of the code. The internal flash memory is not user accessible.

RAM Memory used by the DSP microcomputer (640 KB)

This is volatile memory used to store many parameters needed for the normal operation of the instrument along with current measurement data. It is initialized on power up and is completely cleared when powered down. This memory is not user accessible.

RAM Memory as non-volatile RAM (1 MB)

Non-volatile memory is used to store many parameters such as the current instrument setup, saved instrument setups, offset tables, calibration adjustment values, user-set parameters, etc. The user cannot write to this memory directly, but can store and retrieve instrument set-up parameters in this memory. It can be cleared by an instrument reset operation (see below).

3-2 Secure Mode

Information such as the cal factor frequency needs to be removed from the power meter if the power meter is moved out of a secure environment. This can be accomplished by using the secure mode to completely wipe the non-volatile static RAM of all information.

The user sets the secure mode on the power meter. When the power meter is next turned on the non-volatile static RAM is completely purged of all information. The power meter then sets the factory defaults for the current settings. To set Secure mode on, use the following key sequence:

System | Secure | ON

Secure mode can also be enabled via the SECURE GPIB command (refer to [“SECURE \(Secure system state\)”](#) on page 8-68).

To manually reset the status to factory default, use the factory reset button described below.

3-3 Clearing the Non-Volatile Static RAM

Warning

The following procedure will permanently erase all user data, including saved set-up data.

Turn the instrument on and use the following key sequence:

System | Setup | more | Preset | Factory

3-4 Anritsu Power Sensors EEPROM

Anritsu manufactures several different families of sensors. All families have an EEPROM type of memory device in the power sensor.

All A,B,C sensors (except MA2490/1A and MA2411B series sensors)

These sensors all contain a 64 Kb (8 K x 8) EEPROM.

All D sensors (including MA2490/1A and MA2411B series sensors)

These sensors all contain a 128 Kb (16 K x 8) EEPROM.

EEPROM Contents

The EEPROM is used to store the following information

- Linearity data
- Temperature Correction Coefficients
- Sensor ID
- Factory cal factor data
- User cal factor table data

Only the user cal factor table data can be erased without the functionality of the sensor being affected. This can be done by using the following key sequence:

Sensor | Calfactor | Edit | Clear

Chapter 4 — Connections

4-1 Front Panel Connectors

The front panel connectors are illustrated in the figure below. Detailed descriptions of each connector follow.

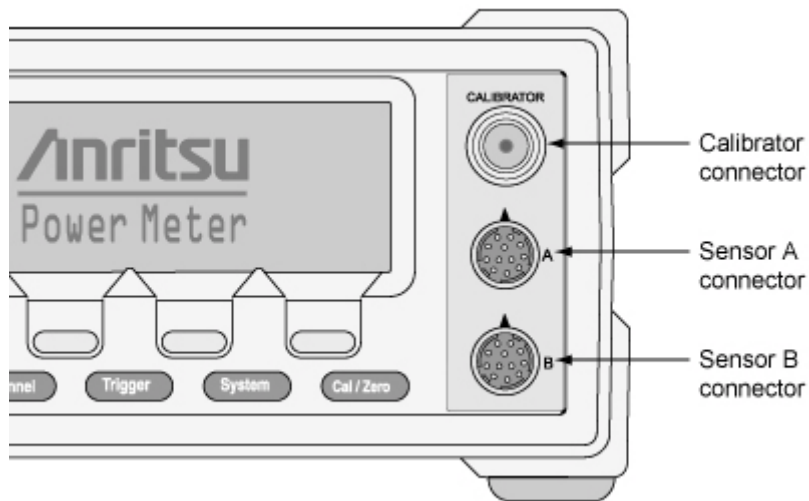

Figure 4-1. Front Panel Connectors

Calibrator Connector

This connector is a precision female N-Type, 50 Ohm connector that provides a precision, traceable 0.0 dBm, 50 MHz reference signal for absolute calibration of the sensors. The calibration signal can be turned on or off through the Cal/Zero menus. Use only compatible 50 Ohm N-Type connectors.

An optional rear panel Calibrator connector is offered as an alternative (see figure overleaf). If the rear panel connector option is installed, the front panel connector is not installed. Refer to Chapter 5, Procedures, for information on using the Calibrator output.

Sensor A Connector

This connector is a 12-pin circular precision connector to be used in conjunction with power sensor cables. An optional rear panel Channel A connector is offered as an alternative (see figure overleaf). If the rear panel connector option is installed, the front panel connector is not installed.

Sensor B Connector (ML2438A only)

This connector is a 12-pin circular precision connector to be used in conjunction with power sensor cables. An optional rear panel Channel B connector is offered as an alternative (see figure below). If the rear panel connector option is installed, the front panel connector is not installed.

Note

Only MA2400A Series sensors can be connected directly to the ML243xA Power Meters. MA4700A and MA4600A Series sensors require the MA2499A or MA2499B Anritsu Sensor Adapter. MP-Series (10-pin) sensors require an MA4001A or MA4002B adapter and an MA2499B.

4-2 Rear Panel Connectors

The Rear Panel connectors are shown in the figure below.

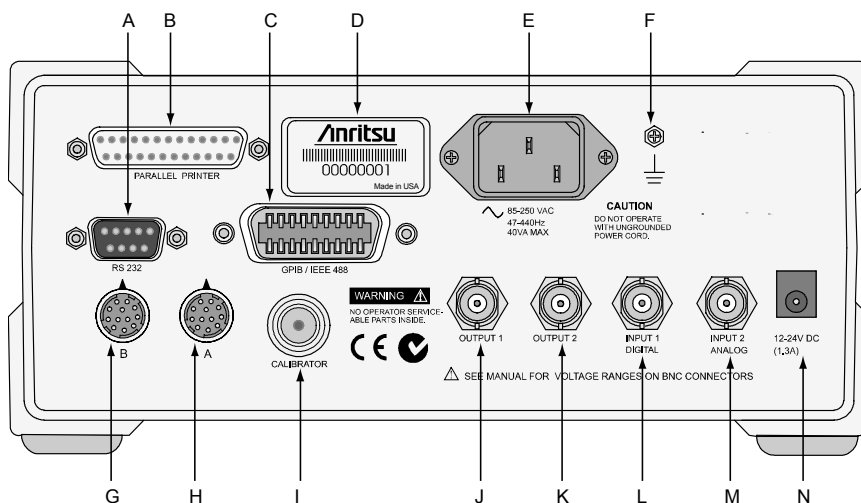

Figure 4-2. Rear Panel Connectors

Table 4-1. Rear Panel Connectors

Key	Item	Description
A	RS232 Serial Connector	Serial control and data output commands are entered using the same format as the GPIB interface. Refer to chapter 5 for more information on using Serial Remote Operation. Allows communication with an Anritsu synthesizer in Source Sweep mode. Also allows service access for software upgrades. The hardware handshake lines RTS and CTS are used to control the flow of data.
B	Parallel Printer Port	Provides an interface to a standard parallel printer. Compatible printers include the Canon BJC80, HP340 Deskjet, and most other 300 and 500 Series HP Deskjet printers.

Table 4-1. Rear Panel Connectors

Key	Item	Description
C	GPIB/ IEEE488 Connector	Standard General Purpose Interface Bus connector used to connect through GPIB to other test equipment and a host computer. The ML243xA is compatible with IEEE-488.1 requirements.
D	ID Number Label	The ML243xA ID number is affixed to the rear panel here. Please use the complete ID number when ordering parts or corresponding with the Anritsu Customer Service department.
E	AC Main Power Input	85-264 VAC, 47-440 Hz, 40 VA maximum. The power meter automatically configures itself for the voltage applied. Connecting AC power here will turn the instrument on. Subsequently, the instrument can be switched between the ON state and the STANDBY state using the front panel ON/OFF button. The optional battery can be fast charged when AC input voltage is applied through this connector and all other power meter functions are off.
F	Chassis Ground	Used as a convenient earth ground reference when DC line power is applied. Used as an optional safety ground when operating from battery power.
G	Sensor Connectors	Alternate Sensor input connectors for Channels A and B. If the rear panel optional connectors are installed, the front panel connectors are not installed.
H	Sensor Connectors	Alternate Sensor input connectors for Channels A and B. If the rear panel optional connectors are installed, the front panel connectors are not installed.
I	Calibrator Connector	Alternate Calibrator output connector. If this rear panel connector option is installed, the front panel connector is not installed. Refer to Chapter 5, Procedures, for information on using the Reference Calibrator output.
J	Output 1	Multi-purpose BNC connector is user-configurable for Modulation Output (TTL), Analog Output 1 (volts/units), or Limits Pass/fail (TTL). Supports pass/fail testing for channels 1 and 2. Also configurable to output a real-time measurement signal from sensor input A, suitable for levelling purposes.
K	Output 2	Multi purpose BNC connector is user configurable for Analog Output 2 (volts/units), Blanking Zero (TTL), or Limits Pass/Fail (TTL). Supports pass/fail testing for channels 1 and 2. Also configurable to output a real-time measurement signal from sensor input B, suitable for levelling purposes.
L	Input 1, Digital	Multi purpose BNC connector is user configurable for Blanking Input (used to ARM measurements in triggering modes) or TTL Trigger Input.

Table 4-1. Rear Panel Connectors

Key	Item	Description
M	Input 2, Analog	Multi-purpose BNC connector used for Volts per GHz connection. Supports 0 to +20 V nominal input voltage with software selectable scaling. V/GHz is used for automatic CAL FACTOR correction by applying an external voltage, scaled to frequency. The correct calibration factor for this frequency is automatically interpolated and applied when in V/GHz calibration factor mode. Different scaling may be applied to sensor A or B allowing for measurement of frequency translation devices. Available simultaneously with channel A and/or B data, the data rate is as set on the channel. The default data rate is 20 ms in DEFAULT measurement mode (with the default settling time of 0.1 %), and programmable in PROFILE operation mode and CUSTOM measurement mode.
N	DC Power Supply Input	Used for 12-24 VDC input in the absence of AC line power. The optional battery can be fast-charged when the DC input voltage is greater than or equal to 21 V and all other functions are off. Fast-charge must be selected from the System menu. The external DC Power Supply input line is protected by an internal fuse.

Chapter 5 — Front Panel Operation

The ML243xA Power Meter is controlled from the front panel using the five main menu keys: Sensor, Channel, Trigger, System, and Cal/Zero. This chapter explains the power-on procedure and the features and functions of each of the menus. Refer to Appendix C for quick reference Menu Maps.

5-1 Front Panel Controls

The front panel controls are shown in the figure below. The following sections provide more detailed explanations of the menus and soft keys.

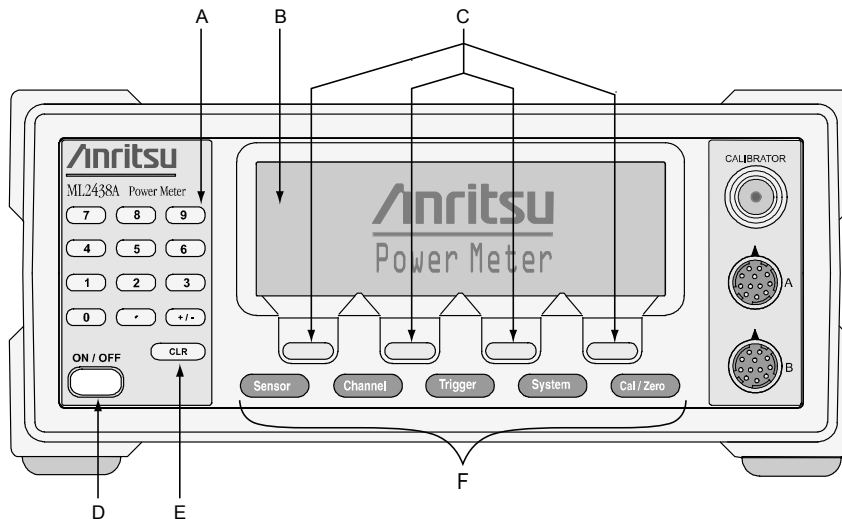

Figure 5-1. Front Panel Controls

Table 5-1. Front Panel Connectors

Key	Item	Description
A	Numeric Keypad	Provides the means for entering numeric data in the appropriate menus as required for system configuration or calibration.
B	Graphic LCD with Backlight	The LCD display settings are configured in the System menus. The backlight can be turned on or off, or time-delayed, as required to suit ambient conditions and battery drain. The backlight is controlled through the System menus when operating from the internal battery.
C	Soft Keys	Soft keys select submenus, toggle selections, control cursor position, and allow data entry. A flashing cursor indicates when numbers can be entered using the numeric keypad. Refer to the following sections of this chapter for detailed information on using the soft keys.
D	Power On /Off	Switches the power meter from STANDBY to ON, or ON to STANDBY. Note that whenever AC power is applied, the power meter defaults to the ON state. Subsequently, the instrument can be switched between the ON state and the STANDBY state using this front panel Power On /Off key. When External or Internal (battery) DC power is first applied to the instrument (no AC present) the power meter defaults to the STANDBY state. It can then be switched to the ON state using the front panel Power On /Off key.

Table 5-1. Front Panel Connectors

Key	Item	Description
E	Clear Key	The clear (CLR) key performs various functions depending on when it is pressed. For example, when editing an entry in a menu, pressing the CLR key clears the digits. If in a menu screen, pressing the CLR key returns to the previous menu level. If the limits FAIL indicator HOLD audible alarm is sounding, pressing the CLR key stops the alarm. The FAIL indication is not affected by the clear key, and can only be cleared by turning fail hold off. If the GPIB box is on the screen and the system is not in a menu screen, and the system is in local mode (menus available), and no GPIB operations are pending, then pressing the CLR key clears the GPIB box off the screen.
F	Menu Keys	When pressed, the first level submenus appear on the display directly above the soft key for that menu function. Refer to the following sections of this chapter for detailed information on using the menu keys.

5-2 Power-On Procedure

At power-on, the power meter performs a brief power-on self test (POST). After the POST, the instrument loads the last used configuration and display settings. If a POST error occurs, information and available options are displayed on the screen.

The following tests are performed during the power-on self test, and also when the GPIB *TST? command is sent.

Table 5-2. Power-on Self Test

Test sequence	Possible status
Flash EPROM code checksum	Pass or Fail
Flash EPROM personality data checksum	Pass or Fail
Flash EPROM calibration data checksum	Pass or Fail
Volatile RAM tests	Pass or Fail
Non-volatile RAM checksums	Pass or Fail WARNING - Software version changed - all non-vol stores reset Current store failed - current store reset Saved store(s) failed - failed store status changed to not saved WARNING - Secure mode clear memory - all non-vol stores reset
Display	Pass or Fail
Keyboard	Pass or Fail

Failure and warning messages that can be displayed on the front panel are:

- Flash code csum
- Personality csumVolatile RAM
- Cal data csum
- Non-Vol RAM
- Software version - this is only a warning
- Current Setup
- Saved Setups
- Secure - Mem clear - this is only a warning
- Display
- Keyboard
- DSP error # - followed by a 4-digit hexadecimal error code

If an error, other than a DSP error, is encountered, the text: "Press ANY key to continue" is displayed at the bottom of the screen. If only warnings are encountered, nothing is displayed at the bottom of the screen, and the unit continues to initialize.

If a DSP error occurs, the text, "Restart unit. If error persists, contact Service Center." is displayed and the unit will halt the self test. Make a note of the hexadecimal error code displayed and contact your nearest Anritsu Service Center.

Self test error messages are also available over the GPIB, as a self test status string (see STERR command in chapter 7).

5-3 Sensor Menu

The Sensor menu has controls for sensor data processing.

Note	When editing an entry in a menu, pressing the CLR key clears the digits. If in a menu screen, pressing the CLR key returns to the previous menu level.
-------------	--

Setup

Selects the data acquisition controls for the sensor. The following submenus are displayed.

SENSOR

Model ML2438A (dual channel) only. Select the sensor to be configured. Toggles between Channel A and Channel B for all submenu functions.

OPTION

Only displayed if a Universal Power Sensor with Option 01 is connected to selected input channel. This key selects between True RMS sensor operation (for WCDMA measurements) and Fast CW (for TDMA/Pulse measurements).

MODE

Note	The MODE selection is not available in Profile or Source Sweep modes.
-------------	---

Select either Default, Modulated Average, or Custom.

Default is the sensor mode setting following system preset. It is the ML243xA simplest operating mode. Measurement speed is automatically adjusted according to sensor response times and the user-adjustable Settling %. Triggering controls, except for GPIB trigger, are disabled when the sensor mode is set to Default. This is intended to simplify basic power measurement by avoiding the necessity of specific trigger settings.

Modulated Average mode is used to stabilize the front panel digital readout. It is a specialized sensor mode for either MA2440A or MA2470A Series power sensors. These sensors are fast enough to demodulate the amplitude modulation of many RF test signals. The Mod Average sensor mode is unnecessary for thermal power sensors.

The Custom sensor mode permits the highest measurement rates. Trigger controls are available with this sensor mode. Trigger Delay (the time between the ML243xA receipt of a valid trigger event and the start of sample integration) and Gate Width (the duration of sample integration) controls are located in the Trigger menus.

When using universal power sensors only default mode is a available unless OPTION is set to Fast CW. Fast CW can only be selected for sensors supplied with option 01.

Note	When measuring modulated signals with a diode sensor, ensure Modulated Average is selected or measurement errors may result.
-------------	--

HOLD [RGH]

Allows the operating range of the selected sensor to be set to the desired range. Select a Range Hold value of 1 to 5, or Auto. When in Auto, the range changes to take the best measurement automatically. Auto is the default setting following system preset.

Table 5-3. Typical Range Hold Values for Diode Sensors

Range	Values
Range 1	above approximately -12 dBm
Range 2	-10 to -27 dBm
Range 3	-25 to -42 dBm
Range 4	-40 to -57 dBm
Range 5	below -55 dBm

SETTLE % [SENSTL]

Settle % per reading is available when the sensor mode is set to Default. The settling time allows some control over the trade-off between speed and the extent to which a measurement has settled to its final value. A 1 % settling value relates to approximately 0.04 dB, 0.5 % relates to 0.02 dB and 0.25 % to 0.01 dB. The default value after a system preset is 0.1 %, or about 0.004 dB. Increasing the Settle percent to 1 % or more will substantially increase measurement speed.

Note SETTLE% affects GPIB speed. Consider this when optimizing GPIB performance.

Calfactor

Allows entry of the calibration correction factor. The calibration factor compensates for mismatch losses and effective efficiency over the frequency range of the power sensor.

SENSOR

Model ML2438A (dual channel) only. Select the sensor to be configured. Toggles between Sensor A and Sensor B for all submenu functions.

SOURCE [CFSRC, CFVAL]

Three selections are available, Frequency, Manual, and V/GHz.

Frequency: In this mode, correction data is read from the EEPROM in the sensor and applied automatically to the measurement based on the user's input frequency. The EEPROM correction data value nearest to the entered frequency is used to calculate the correction applied to the signal. For greater accuracy, calibration factors are interpolated for settings that are between the calibration factor data provided in the sensor EEPROM. For example, if calibration factors exist for 1 and 2 GHz, then the calibration factor applied for 1.5 GHz will be a value midway between the two.

Sensor linearity adjustments for temperature are also interpolated; If the correction factor for 1.5 GHz at 25°C is 1 dB, and for 35 ° C is 1.1 dB, then at 30 °C a value of 1.05 dB will be used.

Note	Frequency or V/GHz are preferred methods as the sensors have internal linearity correction which varies with frequency.
-------------	---

Manual Set: Allows manual correction of sensor data either as a percentage or a fixed dB value. An input frequency is also required to allow the correct linearity correction factors to be applied.

V/GHz: Most modern synthesized sources have a rear panel BNC connector which outputs a voltage proportional to the synthesized frequency. The V/GHz is supplied to the rear panel input connector of the ML243xA. The SETUP submenu has controls for customizing the voltage and frequency relationship.

Note	When the MA2499B Anritsu Sensor Adapter or the MA2497A HP Sensor Adapter are used, the input frequency should be set to 50 MHz irrespective of the measurement frequency. Linearity correction factors are not applied when the adapters are being used.
-------------	--

FREQ [CFFRQ]

When the Cal Factor source is set to Frequency or manual, enter the input signal frequency in GHz or MHz. The correct sensor calibration factor is automatically interpolated and applied to the displayed power reading.

Note	You will see a live update of the Current Cal Factor only if that sensor is being used on a channel. For example: If you are editing the Cal Factor Frequency on Sensor B, but you only have channel 1 set to A and channel 2 off, you will not see the "Current Cal Factor" being updated.
-------------	---

USE TABLE [CFUSEL, CFUTBL, CFUUSE, CFUULD]

Defines which calibration factor table is to be used. Can be set to Factory, table number 1-10, or Factory + table number. The maximum number of tables available is displayed on the screen, and is never greater than 10. If a selected table has not been used before, the user will be prompted to CLEAR or PRESET the table, or cancel the selection. If a table is CLEARED, all entries are cleared except for a single entry of 100 % @ 50 MHz. If a table is PRESET - the factory defined calibration factor table is copied into the specified user calibration factor table. The CLEARED or PRESET table is saved directly to the sensor. PRESET clears the ID string, while CLEAR leaves the ID string as currently set.

The number of tables available is defined by the frequency range of the sensor and the amount of factory calibration data stored.

Note User defined Cal Factor tables are available for applications where user-supplied calibration points are required. Additional cal factor frequencies can be entered in a user table and used in conjunction with the factory table.

Delete: Deletes the currently displayed table number.

Factory: Selects the Factory calibration factor table. Pressing Factory and the +/- key on the numeric keypad allows selection of a user-defined table in addition to the factory table. This allows full factory calibration to be active, and allows adjustments or corrections to be entered in the user-defined table. If user table 1 was selected, the menu would show 'Factory+1' and the Status box on the readout display would show a warning "*" sign on the Cal Factor line (bottom text line in the box) to show that non-standard calibration is being applied (CAL *F or CAL *V).

Enter: Confirms the selection.

Note Whichever set, or sets, of cal factors are used, the linearity and temperature correction remains active at all times. Ensure the power meter is programmed with the frequency of the signal being measured.

%/dB [CFUNITS]

Toggles the Current Cal factor display format from percentage to dB, and back.

EDIT [CFUADD, CFUSAV, CFUCT, CFUPT, CFULD, CFURD, CFUID]

Edit any of the available user calibration factor tables in the sensor. Options available are CLEAR or PRESET the table, enter a new table identity string, change or delete existing frequency/cal factor data pairs, or enter new frequency/cal factor data pairs. All frequency/cal factor data pairs can have both frequency and calibration factor value modified, except for the data pair at 50 MHz, which can only have its cal factor value changed. All frequency/cal factor data pairs can be deleted, but there must always be one data pair remaining. If there is a data pair at 50 MHz, this will be the data pair that will remain.

The user must ensure that the maximum number of cal factor data pairs entered into a table is not exceeded. Sensors with a maximum frequency of up to 40 GHz will hold 90 pairs, while sensors with a maximum frequency of 50 GHz will hold 110 pairs.

Once all changes have been made, the SAVE soft key saves the changed data to the sensor. If any user cal factor data is changed and not saved, any attempt to exit the cal factor menu or select a new table will result in a prompt to discard or save the changes.

FACTOR [CFCAL]

When the Cal Factor Source is set to Manual, the operator is expected to enter the calibration factor value in dB or % terms.

CAL ADJUST [CFADJ]

Sets a calibration factor to be used when performing a 0 dBm calibration and the calibration factor source is set to 'Manual.' This value is the only factor applied when performing a 0 dBm reference calibration. If the sensor calibration factor source is set to V/GHz or Frequency, the sensor internal EEPROM correction value at 50 MHz is used.

SETUP [CVSTF, CVSPF, CVSTV, CVSPV]

Sets up the Start and Stop frequencies and voltages when Source is set to V/GHz. This tells the ML243xA how to determine the frequency of the swept signal based on the applied rear panel voltage.

Averaging

Sensor data averaging. The available soft keys depend upon the operating mode selected.

In Readout and Power vs. Time modes, the following soft keys appear:

SENSOR

Model ML2438A (dual channel) only. Select sensor A or B, in Power vs. Time or Readout modes.

MODE [AVG AVGM]

Select OFF, AUTO, MOVING or REPEAT, in Power vs. Time or Readout modes.

AUTOMATIC averaging uses a MOVING type of average and increases the amount of averaging as the noise level increases. The display updates at approximately 100 ms intervals, however the data is available at the full rate. The display is slowed down to prevent jitter and allow the user to follow the update.

Note

Automatic averaging also applies an algorithm to enhance settling at low power levels (e.g., signal sources).

MOVING average allows the user to manually select the amount of averaging regardless of the signal level. The display is continually updated while averaging.

When selected, the following soft key becomes available:

NUMBER [AVG AVGM]

Sweep averaging number (1 to 512).

REPEAT averaging also allows the user to manually select the amount of averaging regardless of the signal level, however the display is updated only when the NUMBER of readings specified have been taken (1-512).

Note

Due to the nature of this method of operation, if the power level changes between updates, the display update will not reflect the true input power for one measurement only.
When a channel is set to a ratio, e.g., A-B or A/B etc., the repeat method described above only operates if all sensors are set to the REPEAT mode.

Note

GPIB trigger commands automatically apply REPEAT averaging after TR2 commands to ensure 'old' samples are excluded from the measurement. However, the user should be aware that due to the high speed of the meter, other instruments in the ATE system may not be settled.

LOW LEVEL [AVGLL]

Select OFF, LOW, MEDIUM, or HIGH, Low Level Averaging, in Power vs. Time or Readout modes. Sets the low level averaging window for the sensor. At resolution settings of 0.01 and 0.001 dB, digital readouts may flicker due to the high reading rate of the power meter. Low level averaging applies a low pass filter to post-average data readings to achieve a more stable front panel display without slowing down the response of the meter to larger changes in level. The three windows for LOW, MEDIUM and HIGH low level averaging are ± 0.01 , 0.02, and 0.05 dB.

For example: When a LOW setting of low level averaging is applied while stepping from 0 dBm to -1 dBm, the meter displays the final reading within 0.01 dB with no delay. The final settling of 0.01 dB will settle over a short subsequent period of time, leading to a stable high resolution readout.

With a HIGH setting of low level averaging, the settling window is increased (up to approximately 0.05 dB) and the settling time is longer.

With low level averaging OFF, the meter displays the final reading instantly with no further settling observed. Any jitter due to noise is reflected in the displayed reading, which may be inconvenient for high resolution readings.

In Profile and Source sweep modes, the following soft keys appear:

STATE [GRSWS]

Graph averaging state, ON or OFF. When set to ON, the following additional soft keys appear:

A NUMBER [GRSWP]

B NUMBER (ML2438A only) [GRSWP]

Sweep averaging number (1 to 512).

RESET

Sweep average reset. If the graph sweep averaging state is ON, this key resets the data points and restarts the sweep to sweep mode.

CURSOR [GRSWR]

Between cursor averaging ON or OFF. When ON, a digital readout of the average power between the two cursors is displayed in the readout area of the PROFILE display.

Offset

Allows an offset, in dB, to be applied to sensor data for the selected sensor.

SENSOR

Model ML2438A (dual channel) only. Used to select the sensor to be configured. Toggles between Channel A and Channel B for all submenu functions.

TYPE [OFFTYP]

Selects the type of offset to be applied:

Off: No offset applied.

Fixed: A fixed dB offset VALUE is applied to the sensor data.

Table: The tables are a set of frequency-against-dB offsets. The offset value used from the table depends on the setting of the frequency correction source. If the source is FREQUENCY, the entered frequency is used to calculate the offset from the table. If the frequency correction source is V/GHz, the frequency value calculated from the supplied ramp input is used to calculate the offset from the table.

If the frequency does not match any frequency in the table, interpolation is used to calculate the correct offset.

Note

Use Fixed or Table to compensate for a fixed attenuator on a sensor for measuring higher power levels. A better method is to apply a Fixed cal factor in the User tables as this is then taken into account in the Zero/Cal process.

Note

If the frequency is greater than the maximum frequency in the table, the offset value from the maximum table frequency is used. If the frequency is less than the minimum frequency in the table, the offset from the minimum table frequency is used.

VALUE [OFFFIX OFFVAL]

Enter the offset value (dB) when Offset TYPE is set to Fixed. Valid range is -99.99 to +99.99.

TABLE [OFFTBL, OFFTBR, OFFTBU, OFFVAL]

Select the offset table number (1-5) when Offset TYPE is set to Table. When a table is selected, additional soft keys become available:

EDIT:	This will bring up all of the selected offset table's entries, with their associated frequencies and offsets. Select an entry and enter the frequency and offset using the keypad.
CLEAR [OFFCLR]:	When an offset table is selected, CLEAR will set all of the table's elements to zero.

Duty cycle

Applies a duty cycle to the selected sensor. An offset will be applied based on the entered value.

SENSOR

Model ML2438A (dual channel) only. Used to select the sensor to be configured. Toggles between sensor A and sensor B for all submenu functions.

STATE [DUTYS]

ON or OFF

DUTY [DUTYS]

Delete, Enter, or Cancel. An offset will be applied based on the entered value. For example, specifying a duty cycle of 50 % will alter the displayed readings by approximately +3.01 dB.

Rng Hold [RGH]

This function will toggle the sensor between holding the present operating range and Auto Ranging. Auto Ranging automatically selects the best range to take the measurement.

If either sensor is auto ranging, this key will force both sensors to hold their present operating ranges. If either sensor is held within an operation range, this key will force both sensors to Auto Range.

Note

Rng Hold is not available when System > Setup > mode is set to Source Sweep. In this mode, AUTO ranging is used.

5-4 Channel Menu

The Channel menu controls the operation of a display channel. There are two display channels, Channel 1 and Channel 2. Channel 1 appears at the top of the readout display and channel 2 at the bottom. If a channel input configuration is turned off, the remaining channel appears in the centre of the screen.

Note	When editing an entry in a menu, pressing the CLR key clears the digits. If in a menu screen, pressing the CLR key returns to the previous menu level.
-------------	--

The Channel submenus are as follows:

Setup

The setup menu allows the user to set up the configuration of the display channels. The setup parameters are:

CHANNEL

Selects the channel to be configured. Toggles between Channel 1 and Channel 2.

INPUT [CHCFG]

This is the sensor, combination of sensors, or rear panel BNC input that is used to calculate the measured and processed value for this channel. For the ML2437A (single input) power meter, the available options are A, External Volts, or OFF. For the ML2438A (dual input) power meter, the options are A, B, A – B, B – A, A/B, B/A, External Volts, or OFF.

UNITS [CHUNIT]

The units can be dB(m), Watts, dBV, or dBmV. If the External Volts input is selected, the units are fixed to Volts.

RESOLUTION [CHRES]

The number of decimal places in which the results are displayed in Readout mode, with certain limitations. If the units selected are in Watts or Volts, and the value goes down to pW or V, the number of decimal places is forced to zero. If the number to be displayed is too large for the number of decimal places selected, the decimal places displayed will be reduced.

MIN/MAX [MNMXS GMNMX]

This selection turns on the Min/Max Tracking for the display channel selected. On the top line of the data display, when not in menu mode, the min and max of the channel data (after combination and unit conversion calculations) is displayed. The left hand set of data is for display channel 1 and the right hand set for display channel 2.

In Profile mode, the Min/Max is between cursors only, as controlled by selecting SINGLE or INFINITE through the System > Graphics > TRACKING menu. SINGLE (default) is the most useful as it provides a continuously updated readout of the Min/ Max points within the cursor window. The INFINITE setting is used when the results needs to be collated over a large number of samples.

Note	Use MIN/MAX to track variations in a measurement over time, or while adjusting external devices or tuning over frequency.
-------------	---

RESET [MMRST]

This function resets the Min/Max (when ON) for the channel selected.

Rel 1 [REL]

After the relative power level is set by the operator, the Relative mode subtracts that value from the current measured power. If selected when in Relative mode, the relative operation for channel one is turned off.

Pressing the Rel 1 soft key when in Readout mode will subtract the last used relative value. Hold down the key to retake this value. The readout will display 0.00 dBr. This relative value will be used thereafter until it is replaced by another one in the same manner. This allows the user to refer to a previously referenced value, without the meter resetting itself back to a 0.00 display.

Rel 2 [REL]

Relative mode control for Channel 2 is labelled Rel 2.

Limits

Pressing the Limits menu soft key displays the test limits for the selected channel. This menu sets individual high and low pass/fail limits for the two display channels. These limits drive the PASS/FAIL display flags and the PASS/FAIL TTL output if selected.

In Power vs. Time graphic mode and Readout digital mode, each fail of the limits produce a separate fail flag and fail beep (if ON) and also drive the rear panel BNC (if enabled) for each pass or fail reading. In PROFILE mode, each fail of the limits produce a fail beep (if ON) and hold the fail output if any point in a sweep fails. If FAIL indicator HOLD is ON, both the screen FAIL indicator and the BNC output are held in the fail state whenever the limits specified for the channel have been exceeded, regardless of whether the reading subsequently goes into pass or not. This state remains until FAIL indicator HOLD is turned OFF.

CHANNEL

The limits are set for the selected display channel unit type. The display channel units selected when the limit was originally set or turned on become the limit units. If the display channel units are changed, and the limits not altered, limit checking is turned off for that channel. If the display channel units are subsequently returned to the same units selected when the limit was entered or turned on, limit checking is turned on again.

Whenever the limit units are active, limit checking is applied as follows: If the channel value is greater than the high limit, and the high limit is turned ON, a FAIL is indicated. If the channel value is below the low limit, and the low limit is ON, a FAIL is indicated. Otherwise, if any limit is ON and a FAIL is not detected, PASS is indicated.

HIGH Limit [HLIM]

Sets the high limit. It is not necessary to enter the units as the limit value is checked against the displayed value. Therefore, if the limits have been set for -10 dBm and the display units are subsequently changed from dBm to Watts, the system still checks for the reading to rise above -10 , even though the display units type has been changed.

Table 5-4. High Limit

Units	Min	Max
dBm	-99.99	+99.99
dBmV	-53.00	147.00
dB μ V	7.00	207.00
Watts	0.0	50.0

Setting a limit value automatically turns on the limit state, except when done via GPIB.

LOW Limit [LLIM]

Sets the low limit. It is not necessary to enter the units as the limit value is checked against the displayed value.

HIGH State [HLIMS]

Select ON or OFF to enable or disable high limit checking.

LOW State [LLIMS]

Select ON or OFF to enable or disable low limit checking.

FAIL HOLD [FHOLD]

If FAIL HOLD is ON, both the screen FAIL indicator and the BNC output are held in the fail state whenever the limits specified for the channel have been exceeded, regardless of whether the reading subsequently goes into pass or not. This state remains until FAIL HOLD is turned OFF.

BEEP [FBEEP]

If BEEP is ON, and FAIL HOLD is OFF, whenever the limits specified for the channel have been exceeded, a single beep sounds.

If fail BEEP is ON and FAIL HOLD is ON, whenever the limits specified for the channel have been exceeded, a beep will sound once every second until FAIL HOLD is turned OFF, or the CLEAR key (CLR) is pressed.

The FAIL indication is not affected by the CLEAR key, and can only be cleared by turning FAIL HOLD off. If a limit fail happens again, the alarm will sound again.

5-5 Trigger Menu

The Trigger function in the ML243xA allows the user to define under what conditions measurements are taken, and the time period they are taken over. For instance, the READOUT mode can be configured to display the average power of the ON period of a square wave, or an individual slot in a GSM burst.

The Trigger menus are always available in PROFILE operation mode, as selected from the System menu. If PROFILE cannot be selected within the System > Setup submenu, change the GPIB mode to ML24XX in the System > Rear Panel submenu.

In READOUT or Power vs. Time modes, the trigger setup menus are available if the channel input configuration SENSOR > Setup > MODE is set to CUSTOM. A display channel using more than one sensor (A–B for example) where either sensor is in CUSTOM mode, is assumed to be in custom mode and can use triggering. Trigger setup is available only for the display channels that meet the above criteria.

In PROFILE mode, the display shows an 'x' marking the trigger point plus the display trigger delay time, updated for each new set of data. This trigger point mark rotates as the profile data is updated, changing between '-' and '+' on each data update. On rapid updates, the trigger point mark may appear like a star (s), as it is rotating so quickly. In manual, external or GPIB triggered displays, the mark rotates at a slower rate and each true data update can be seen.

This point can be moved across the x axis by the pre trigger percentage. If the trigger source is either default, mod average or custom continuous, the trigger point has no meaning since the system is continuously triggering. The mark does not appear in the Power vs. Time or Source Sweep modes, as it is not applicable.

Trigger icons indicate the type of triggering selected and appear level with the related channel on the far left of the screen. Trigger icons are not displayed if the system is in Profile, Power vs. Time, or Source Sweep operation modes, if all sensors used in a channel input configuration are in the DEFAULT measurement mode, or if the peakmeter is displayed.

Note

When editing an entry in a menu, pressing the CLR key clears the digits. If in a menu screen, pressing the CLR key returns to the previous menu level.

The trigger icons are shown in the figure below.

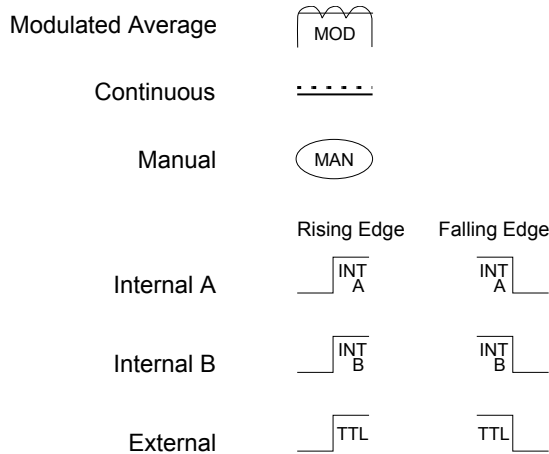

Figure 5-2. Trigger Icons

Note External trigger is only effective at 800 kHz or lower.

Only when a channel input configuration includes a sensor with a measurement mode that requires an icon, will an icon be displayed.

Setup

This menu is used to set up the trigger conditions for the display channels. In readout display mode with sensor mode set to custom, the trigger can be set to display channel 1 and 2 separately, or together as channel 1 & 2.

The channels are triggered simultaneously if the trigger conditions are set to 1 & 2. This guarantees the trigger conditions are the same, and therefore the readings are taken at the same time. In Readout and Power vs. Time modes, if the menu is exited with the trigger selection at channel 1 & 2, this setup is used for trigger control. Otherwise, if the trigger setup display is left with channel 1 or channel 2 displayed, the individual trigger settings are used for trigger control.

Note Simultaneous trigger channels guarantee identical sampling for both channels, essential for accurate ratio (A/B) measurements.

CHANNEL [TRGMODE]

Select display channel 1 or 2 (or 1&2 when setting trigger conditions in Readout or Power vs. Time modes).

SOURCE [TRGSRC GTSRC]

The trigger sources are CONTINUOUS, Internal A, Internal B (ML2438A only), EXTTTL, or MANUAL. When the trigger source is set to INT A or INT B (Internal A or B) the power meter triggers on a rising or falling power level on the associated sensor. See LEVEL for the setting of the trigger power level.

DELAY [TRGDLY GTDLY]

In Profile mode, DELAY sets the time delay (after the display trigger delay) to when the system starts to take and display readings, represented by the left most cursor. Enter 0.0 to 1.0 seconds, in ms or μ s.

Note

Changing the left most cursor, or the trigger delay time, updates the cursor or the delay time value accordingly. In Profile mode, moving the cursor only allows updates to the pixel resolution of the display. In Power vs. Time mode, the delay and width can be used to alter the update rate.

In Readout mode (CUSTOM sensor mode), the value entered for DELAY is applied after a trigger event, and before samples are taken. Enter 0.0 to 1.0 seconds, in ms or μ s.

WIDTH [TRGGW GTGW]

Enter 100 ns to 7.0 s (the default is 20 ms). In Profile mode, WIDTH is the gate time the system uses to perform a cursor average measurement. The time interval is represented by the space between the left most cursor and the right most cursor. Changing either cursor, or the gate width value, updates both the cursors and the gate width value.

In Readout mode, this value defines the measurement gate width. A measurement is presented as the average of all data taken in this gate width.

In Power vs. Time mode, the delay and width can be used to alter the update rate or sample rate.

Note

The averaging function averages a number of gate WIDTHS, so for a given averaging number, larger WIDTHS will take longer to AVERAGE. Narrower widths will average faster (but may yield a less-settled measurement).

EDGE [TRGXTTL GTX TTL]

When set to External TTL, the power meter triggers on a TTL level rising or falling. This selection sets the trigger for either a rising or falling edge.

ARMING [TRGARM GTARM]

Sets the trigger arming, unless the trigger source is set to EXTTTL. When ARMING is set to Blanking ON, only samples taken when the rear panel Digital Input BNC is active will be averaged in the measurement. The polarity of the rear panel Digital Input BNC signal can be set (high or low) using the System > Rear Panel > BNC > TTL LEVEL menu setting.

Note

Use Arming to synchronize to other equipment or modulation/burst synchronization. This is a simple way to inhibit measurements during user-defined periods without entering actual time periods.

When ARMING is set to Blanking OFF, all samples are read irrespective of the level on this BNC.

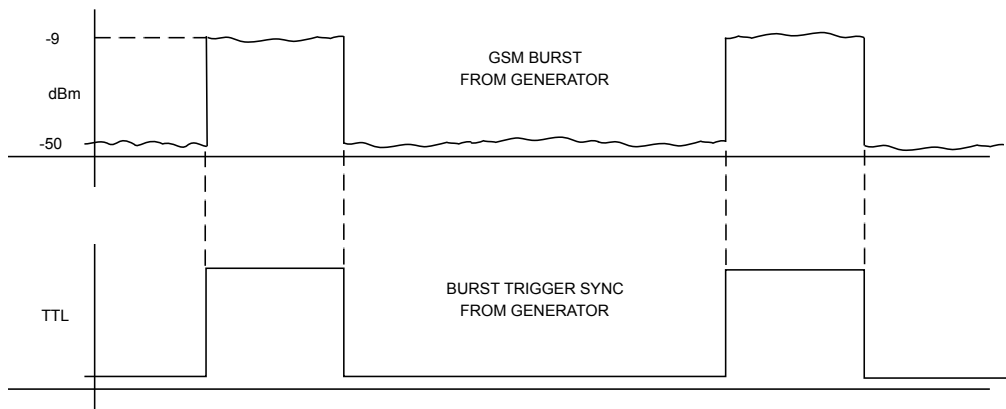

Figure 5-3. Typical Arming Diagram

1. Connect to the rear panel digital input.
2. Select Trigger > Setup > ARMING > Blanking ON.
3. Set the polarity of the blanking (System menu)

Example power meter reading: -9.16 dBm.

TYPE [TRGTYP GTTYP]

The Type selection (RISE or FALL) sets the trigger for a rising or falling edge. When the trigger source is set to INTA or INTB (Internal A or B) the power meter triggers on a power level which is rising or falling.

LEVEL [TRGLVL GTLVL]

The Level selection sets the internal trigger level. When the trigger source is set to either INTA or INTB (internal sensor A or B) the channel triggers on a power level (in dBm) given by the sensor. This value must not take any cal factors or offsets that the meter applies into account.

Trig 1

If Trigger Channel 1 SOURCE is set to Manual, this softkey initiates a measurement for channel 1.

Trig 2

If Trigger Channel 2 SOURCE is set to Manual, this softkey initiates a measurement for channel 2.

Trig 1&2

If Trigger Channels 1 and 2 SOURCE are set to Manual, this softkey triggers both channels simultaneously.

Note The effective range is approximately -30 dBm and is only active in DC ranges 1 and 2.

The following figure shows a typical trigger timing diagram. Note that the display trigger delay is only present when in Profile operation mode, and helps in setting the 'window' position along the signal.

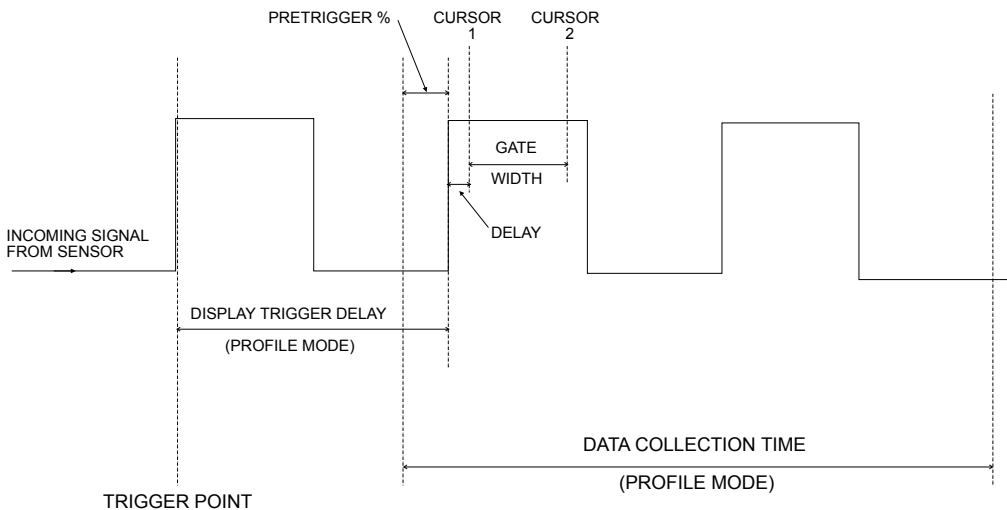

Figure 5-4. Sample Trigger in Graphic Mode

The Data Collection Time (collection period) is only present when in Profile operation mode (System > Profile > PERIOD), and is the period of time displayed on the profile graph.

The Gate Width is the section of the signal in which the measurements are performed. In Profile mode, this is the time between Cursor 1 and Cursor 2 and is used to provide the Between Cursor Average measurement.

Display Trigger Delay (System > Profile > DELAY) is the delay after the trigger point.

The Pretrigger % (System > Graphics > PRE TRG%) is only used in the Profile mode, and shows a percentage of the data collection time as pretrigger information. If the display trigger delay is less than the pretrigger delay period, there will be no Pretrigger information as it will be before the trigger point itself.

Setting the display trigger delay to the length of the data pulse causes a trigger on the first pulse, but displays the second pulse with valid “pretrigger information.” This is the best method for repetitive signals and can be used to verify signal repetition intervals.

Note External trigger is only effective at 800 kHz or lower.

5-6 System Menu

The System menus control the operating modes, display visibility, sound, rear panel functions, and battery state of the ML243xA Power Meter. Note that the soft keys will appear differently depending upon the operation mode selected with the Setup soft key below.

Note

When editing an entry in a menu, pressing the CLR key clears the digits. If in a menu screen, pressing the CLR key returns to the previous menu level.

Setup

This menu selects the operation mode, allows system setups to be saved or recalled, and provides two options to reset the system parameters to the default setup.

MODE [OPMD]

Select between Readout, Power vs. Time, Source Sweep and Profile operation modes. If only Readout is available, check the System > Rear Panel > GPIB > Mode setting. This setting must be ML24XX for Profile, Power vs. Time and Source Sweep modes to be available.

Note

When using the ML243xA Series Power Meter with an MA2499A or MA2499B Sensor Adapter, only Readout and Power vs. Time modes are allowed.

SAVE [*SAV SYSLD SYSRD SYSLNM]

Save the current instrument setup in one of 10 memory locations.

RECALL [*RCL SYSLD SYSRD SYSLNM]

Recall a saved instrument setup from one of 10 memory locations.

LINK [LINK]

There are two trigger conditions saved; one for Profile mode and one for Readout mode. Normally, Profile mode trigger conditions can be changed without affecting the trigger conditions used in Readout mode. With LINK set to ON, the Profile mode trigger conditions are used for both Profile and Readout modes.

In Profile mode, the user can view what is being measured with the selected trigger conditions, but only over a limited dynamic range, as it only uses the two DC ranges of the signal channel. Profile mode measurement rate is also limited by sweep speed.

With LINK readout/profile trigger set to ON, switching to Readout mode uses the same trigger conditions, but allows the full dynamic range of the meter to be used, as well as providing full GPIB speed on data acquisition.

When moving between Readout and Profile modes, with LINK enabled, the value used for “sample delay” is modified using the “display trigger delay.” In Readout mode, the “sample delay” and “display trigger delay” values are combined as “sample delay,” whereas in Profile mode they are both available separately.

Note With LINK set to ON, Readout mode is temporarily forced to Custom mode, and the default and Mod Average modes are inhibited. To use these modes, deselect LINK.

FAST

Fast recall of a saved instrument setup from one of the 10 memory locations. In FAST system recall mode, a single key press recalls a saved setup. A message across the lower area of the screen will prompt for keypad keys 1-9, or 0, to be pressed to recall setups 1-10 (if saved setup data is available in the selected location). The -exit- softkey or any other menu key will exit fast recall mode.

PRESET

Resets the system parameters to the default setup.

RESET [*RST] This selection will reset the system setup. The offset tables and the GPIB interface will not be affected.

FACTORY [FRST] This selection will reset the system setup, including the offset tables and GPIB interface.

Profile

This soft key becomes available when the System > Setup > MODE is set to Profile. Profile operation mode includes the following display controls:

CHANNEL [GRMD]

Select Channel 1 or Channel 2. The channel selected will be displayed on the left of the screen, above the middle value of the y axis and is used for all Profile data displays.

PERIOD [GRPRD]

Sets the time period over which the system collects data and scales the data into the profile graph after a trigger event. Enter the data collection period in ms or s. See System > Graphics > Pretrig % to move the t=0 (trigger event position) of the displayed waveform.

Note PERIOD sets the x-axis time.

DELAY [DTRGD]

Specifies the period of time after a trigger event to delay the start of the display window. For the trigger to line up with the marked trigger point on repetitive waveforms, the delay period should be either zero, or set to integer multiples of 1/PRF (Pulse Repetition Frequency). Enter the delay period in ms or s.

DATA HOLD [GRPIX]

This selects how the graph is displayed on the screen. Select from NORMAL, Min&Max, Min, or Max. This is useful for tracking peak levels over a period of time or detecting glitches.

Note If either Min&Max, Min, or Max is selected, the display will keep the “old” data and may appear stationary. The DATA HOLD mode in use is displayed on the left of the screen, below the middle value of the y axis.

With Min & Max selected, the minimum and maximum points for each sample are shown. If Connect Points is ON (default) (SYSTEM > Graphics > CONNECT), a vertical bar is drawn between these points. See CLEAR, under CONTROL to restart the process.

Min displays only the minimum for this sample position until reset by returning to NORMAL. Max displays only the maximum for this sample position until reset by returning to NORMAL.

Power vs. Time

This soft key becomes available when the System > Setup > MODE is set to Power vs. Time mode. Power vs. Time mode displays measurements in a chart-like format showing history over a period of time. The measurements displayed are taken under the conditions of the Readout mode, and can therefore include all triggering and correction settings set up in that mode.

Power vs. Time operation mode includes the following display control:

CHANNEL [GRMD]

Select Channel 1 or Channel 2. The channel selected will be displayed on the left of the screen, above the middle value of the y axis.

DATA HOLD [GRPIX]

Selects how the graph is displayed on the screen. Select from NORMAL, AVG, Min&Max, Min, or Max.

TIME [GRDDT]

Sets the data hold time, from 1 minute to 24 hours.

Source Sweep

This soft key becomes available when the System > Setup > MODE is set to Source Sweep. The Source Sweep mode provides interconnection between a signal source/generator and the power meter. Using simple techniques, this can provide swept power-accurate measurements over any frequency range at very high speed. The sweep data is available over GPIB and can provide a simple low cost scalar analyzer function.

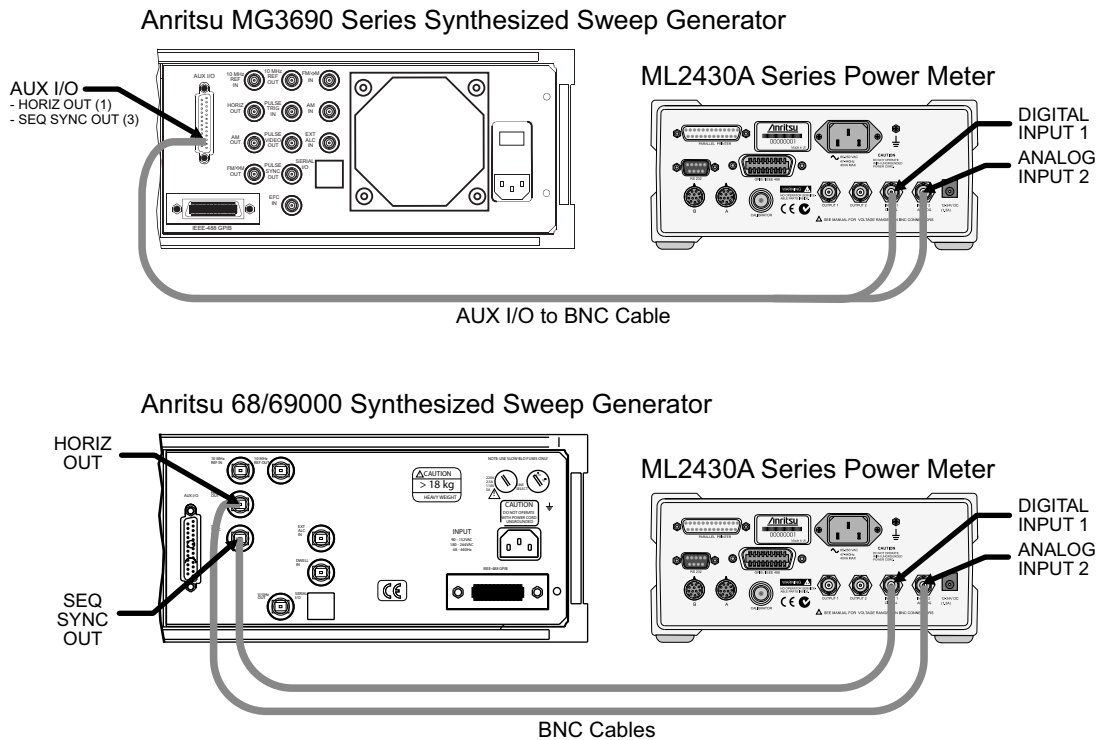

Figure 5-5. Source Sweep Mode Interconnection Example

If the source used does not provide a blanking output, the blanking signal may be disabled as follows: select System > Rear Panel > BNC. Select PORT until INPUT 1 (digital) is selected, then select TTL Level to alter the active state of the blanking signal expected. Setting the TTL Level to LOW will allow the Source sweep to progress without a Blanking signal. This is useful for third party sources or simple VTO systems. If a Source Sweep is later selected which does provide a blanking signal, remember to restore the polarity of this signal to HIGH or an incorrect display will result. Operating a source sweep which has BANDSWITCH blanking delays in it without an appropriate blanking signal may lead to glitches in the resulting measurement at the bandswitch points (simple VTO systems do not usually have bandswitch points).

Note Anritsu MG3690-series synthesizers provide both HORIZ OUT and SEQ SYNC OUT signals via the AUX I/O 25 pin D-connector using Anritsu cable part number 806-97. Refer to the signal source manual for rear panel connection details.

Source sweep operation mode includes the following display controls:

CHANNEL [GRMD]

Select Channel 1 or Channel 2. The channel selected will be displayed on the left of the screen, above the middle value of the y axis.

DATA HOLD [GRPIX]

This selects how the graph is displayed on the screen. Select from NORMAL, Min&Max, Min, or Max.

With Min & Max selected, the minimum and maximum points for each sample are shown. If Connect Points is ON (SYSTEM > Graphics > CONNECT), a vertical bar is drawn between these points. Min displays only the minimum for this sample. Max displays only the maximum for this sample.

Note	If either Min&Max, Min, or Max is selected, the display will keep the “old” data and may appear stationary. The DATA HOLD mode in use is displayed on the left of the screen, below the middle value of the y axis.
-------------	---

MODE [SRCMOD]

Source sweep mode: FREQUENCY or POWER.

START [SRCSTFRQ SRCSTPWR]

Sweep start frequency (MHz or GHz) or power (dBm).

STOP [SRCSPFRQ SRCSPWR]

Sweep stop frequency (MHz or GHz) or power (dBm).

Note	When the power meter is communicating with a signal source/generator over the serial interface, if the source frequency power level or the frequency itself is changed, the source sweep display will be updated where appropriate.
-------------	---

Control

The Control menu adjusts cursor position and toggles the readout display in Profile, Power vs. Time and Source Sweep modes, and provides control over display scaling.

SWAP << >> [CUR]

SWAP selects which cursor to move. The presently selected cursor is defined by a triangular marker at the top of the cursor line. Press the << soft key to move the selected cursor left, and the >> soft key to move the selected cursor right. Trigger delay and Gate Width are related to the cursor positions. This feature aids in measurement of pulsed signals. Changing either cursor, or adjusting the Gate width value, updates both the cursors and the gate width value.

When enabled through the System > Sound > CURSOR menu selection, if a cursor is moved into an illegal space such as the edge of the screen or the end of valid data (trigger point on the left of the screen) a warning beep will sound.

SCALE [GRYT GRYB]

Adjust the Y-axis of the graph using TOP dB Value and BOTTOM dB Value parameters in the SCALE submenu. AUTO scale is based on the min and max of the previous sweep.

READOUT [GRDATA GRDRQ]

The supplemental data readout is displayed or removed with the READOUT soft key. The readout provides display data depending on the graph mode and the data hold type selected, as shown below.

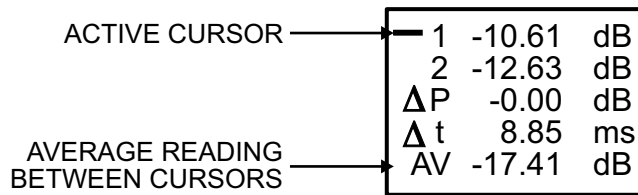

Figure 5-6. Sample Readout Display

Profile Mode**Data hold = NORMAL:**

- 1 cursor 1 reading
- 2 cursor 2 reading
- ΔP Power difference between cursor 1 and cursor 2
- Δt Time difference between cursor 1 and cursor 2
- AV Between cursor average if ON

Data hold = MIN (or MAX):

- 1 cursor 1 minimum reading, or maximum if MAX mode
- 2 cursor 2 minimum reading, or maximum if MAX mode
- ΔP Power diff between cursor 1 and cursor 2 minimums
(or maximums if MAX mode)
- Δt Time difference between cursor 1 and cursor 2 minimums
(or maximums if MAX mode)

Data hold = MIN&MAX:

- 1 cursor 1 MIN reading
cursor 1 MAX reading
- 2 cursor 2 MIN reading
cursor 2 MAX reading
- Δt Time difference between cursor 1 and cursor 2

Power vs. Time Mode**Data hold = NORMAL or AVERAGE:**

- 1 cursor 1 reading
- 2 cursor 2 reading
- ΔP Power difference between cursor 1 and cursor 2
- T1 Time at cursor 1
- T2 Time at cursor 2

Data hold = MIN (or MAX):

- 1 cursor 1 minimum reading, or maximum if MAX mode
- 2 cursor 2 minimum reading, or maximum if MAX mode
- ΔP Power diff between cursor 1 and cursor 2 minimums
(or maximums if MAX mode)

T1 Time at cursor 1

T2 Time at cursor 2

Data hold = MIN&MAX:

1 cursor 1 MIN reading
cursor 1 MAX reading

2 cursor 2 MIN reading
cursor 2 MAX reading

Δt Time difference between cursor 1 and cursor 2

Source Sweep mode

Data hold = NORMAL or AVERAGE:

1 cursor 1 reading

2 cursor 2 reading

ΔP Power difference between cursor 1 and cursor 2

X1 X axis at cursor 1

X2 X axis at cursor 2

Data hold = MIN (or MAX) :

1 cursor 1 minimum reading, or maximum if MAX mode

2 cursor 2 minimum reading, or maximum if MAX mode

ΔP Power diff between cursor 1 and cursor 2 minimums
(or maximums if MAX mode)

X1 X axis at cursor 1

X2 X axis at cursor 2

Data hold = MIN&MAX:

1 cursor 1 MIN reading
cursor 1 MAX reading

2 cursor 2 MIN reading
cursor 2 MAX reading

CLEAR [GPRST]

Available in Profile, Source Sweep and Power vs. Time modes when the DATA HOLD representation selection is not set to NORMAL (or AVERAGE for Power vs. Time). Pressing the CLEAR key restarts the min/max collection.

LINK CURSOR [CURLK]

Links the screen cursors in Profile and Power vs. Time modes so that when one is moved, both are moved. When the cursors are linked, a horizontal bar is drawn between them on the screen. If one cursor is moved, the other cursor moves with it to maintain their relative positions and time interval between them. When the cursors are linked, the relative time positions are altered by adjusting the gate width in the TRIGGER > SETUP > WIDTH submenu.

HOLD [HOLD]

In Profile, Power vs. Time, and Source Sweep modes the graph HOLD function allows a graph to be held and printed. The key action is a toggle action, with the warning message Graph Display HELD displayed at the top of the screen when HOLD is active. Whenever measurement setup parameters are changed, graph hold will automatically be released.

AUTO scale [GRAUTO]

Auto scale for all graphic modes (Profile, Source Sweep and Power vs. Time). In Profile and Source Sweep modes, auto scale will be based on the min and max of the previous profile or sweep.

Display

Controls the characteristics of the LCD display.

BACKLIGHT [DBLGHT]

Controls the LCD backlight during internal battery operation. Can be ON, OFF, or timed to go off after a specified period to save battery life. The backlight is always on during AC or external DC power operation.

Contrast DOWN [DCONTD, DCONT]

Reduces the display contrast. Adjust to suit ambient conditions.

Contrast UP [DCONTU, DCONT]

Increases the display contrast. Adjust to suit ambient conditions.

TIMED [DBLTIM]

Sets the time limit when the backlight will turn off if the BACKLIGHT setting is set to TIMED. Enter a value from 0.0 to 100.0 minutes.

PEAKMETER [DPEAK]

Turns on the peakmeter display for Sensor A, Sensor B, or both Sensors A and B. The peakmeter display will eclipse any trigger icons. The peak meter display range covers 12 dB. When above the displayed maximum or below the displayed minimum, the range is switched by 10 dB in the appropriate direction.

Note that in the event that the channel is displaying an alternative measurement (for example, external volts from the rear panel BNC) the peak meter will continue to represent the Sensor A and/or B data. This is useful for monitoring an external voltage on the meter, while peaking up a response being monitored by a sensor, such as RF output.

FREQ [FROFF]

Turns FREQUENCY offset display ON or OFF. When ON, a continuous indication of the frequency (used for Cal Factor) is displayed in small text at the top of the display along with any sensor offset (if applied).

TEXT [TEXT, TEXTS]

GPIB user TEXT display ON or OFF. When ON, a user-defined text string can be displayed at the top of the display area. The text string can only be defined over the GPIB.

Sound

Controls system sounds.

KEY [KEYCK]

Turns the audible key click on or off.

EDIT [ENTERR]

Turns the audible edit error tone on or off.

LIMIT 1 [FBEEP]

Limit Fail beep on channel 1 on or off.

LIMIT 2 [FBEEP]

Limit Fail beep on channel 2 on or off.

CURSOR

CURSOR out of screen beep. If a cursor is moved into an illegal space, such as the edge of the screen or the end of valid data, a warning beep is sounded.

Print [PRINT]

This selection prints the screen and various operational settings through the rear panel printer port.

```

                                ANRITSU Power Meter ML2437A s/n: 97180010

Firmware: 2.02
Sensor A: NOT FITTED

Sensor Measurement Setup
    Measurement mode           A: Default
    Cal factor                 Frequency (50.00MHz)
    Averaging mode & number    Auto
    Low level averaging        Low
    Offset type & value        Off
    Settle % per reading       0.10%
    Range hold                 Off
    Sensor zeroed              No

Measurement Channel Setup      1: (A)                2: OFF
    Trigger source              Continuous
    Trigger sample delay        1.00ms
    Trigger gate width          20.00ms
    Trigger arm                  Blanking OFF

    High limit                  Off
    Low limit                   Off
    Limits test                  Off

Readout                        1:
    Measured value              -----

```

Figure 5-7. Sample ML2430A Series Printout

Battery

Controls battery setup when the optional battery pack is installed.

AUTO [BAUTS]

Enables or disables the automatic power off feature. Automatic power off can be used to conserve battery power when operating from the internal battery.

TIME [BAUTT]

When operating from the internal battery, Time sets the number of minutes that the instrument will run before powering off in absence of any key activity. Enter a value of 10 to 240 minutes.

STATUS

Displays the installed battery type, remaining capacity (%), estimated operating time remaining (minutes), and the battery's full charge capacity (mAh).

Note

Immediately after power-on, the "estimated operating time remaining" displayed may not be genuine, as the battery requires a few minutes to calculate the present rate of discharge. An accurate indication will be displayed only after a few minutes of continuous operation.

CHARGE

Available only when the instrument is being powered by AC line power or external DC power greater than 21 volts. This selection starts the battery charging cycle. Note that the instrument will shut down during the charging cycle, and restart automatically when the charging is completed. A series of 10 beeps signals completion of the charge cycle.

Rear Panel

Controls for rear panel connections are located in the Rear Panel submenu.

GPIB

Sets the GPIB address and emulation modes.

ADDRESS [ADDR] Set the GPIB address for the power meter. The default is 13.

MODE [EMUL] Selects the power meter emulation mode. Select from ML24XX (native), HP436A, HP437B, HP438A, or ML4803A modes.

BUFFER [BUFF] If **BUFFER Enabled** is **TRUE** (default): In the ML243X native mode, 488.2 GPIB operation, when a request for data is made the response is put in an output buffer ready to be read by the controller. If another data request is made and the previous data has not been read out of the output buffer; the new data is queued after the original request. In this mode of operation the GPIB response buffering enable is **TRUE**, and following the 488.2 specifications, the response should be read when ever a request for data is made. If **BUFFER Enabled** is **FALSE**: In this mode when ever a request for data is made, (except by serial poll) the output buffer is cleared and the only data in the output queue will be the response to the last data request made. The output buffer is cleared once a valid GPIB data request command has been recognized.

Note

BUFFER Enabled TRUE is the default. Use **FALSE** when programming simple command sequences to read data and you do not want to bother with decoding status or keeping track of multiple results or readings.

RS232

Sets the serial communication parameters.

MODE [RSMODE]	Selects External Communication or Source IF. External Communication allows GPIB type commands to be sent to the power meter over the serial interface from a local computer or a remote computer via a modem. Source IF allows the power meter to communicate with an Anritsu synthesizer when the operation mode is set to Source Sweep.
BAUD [RSBAUD]	Sets the serial port BAUD rate. Select from 1200, 2400, 4800, 9600 (default), 19200, or 38400. The other RS232 serial parameters are fixed at 8 bits, 1 stop bit, and no parity.
MODEM	This menu controls how a modem will react when the power meter attempts to connect to a remote computer. It allows entry of a PHONE number, redial COUNT and redial DELAY, and permits INITialisation of a connected modem.
PHONE number [MODPH]	The phone number can be up to 40 digits. When the number is being dialed, a dot (.) will be interpreted as a 2-second delay in the dialing sequence; a minus sign (-) will be interpreted as wait for another dialing tone.
Redial COUNT [MODRED]	If the dialed number does not connect, because it was not answered or was engaged, then the power meter will try to redial the same number according to the count specified. This has a minimum value of 0, maximum value of 10 and default value of 5.
Redial DELAY [MODDEL]	If the dialed number does not connect, and is to be redialled, this value specifies the delay in minutes before redialling. This has a minimum value of 1 minute, maximum value of 10 minutes and a default value of 5 minutes.
INITialize Modem [MODINIT]	This is a single shot command to reinitialize a connected modem. As at power on, if this command is executed with a PC connected directly to the power meter, then a string of modem commands will be seen by the PC.
AUTO	Sets up the power meter to autodial if there is a LIMITS test failure, sensor RANGE error, or the instrument POWER is cycled.
LIMITS [MODLIM]	If this is set, and the limits fail, then the number specified in the "phone number" field will be dialed. Remote communications can then continue as normal.
RANGE [MODRNG]	If this is set, and there is a signal channel range error, then the number specified in the "phone number" field will be dialed. Remote communications can then continue as normal.

POWER [MODPWR] If this is set, and the power cycles on the meter, then the number specified in the “phone number” field will be dialed. When a connection is established, an SRQ will be sent to the host PC. Remote communications can then continue as normal.

BNC [OBMD, OBCH, OBVST, OBVSP, OBDST, OBDSP, OBCH, OBPL, OBACM, OBCH, OBZL, IBBLP]

Configures the input and output rear panel BNC connectors.

PORT Output 1 or 2: Select the output port to configure (see MODE below).

Input 1 Select what type of Blanking input you are providing (see TTL LEVEL below) on Input 1.

Input 2 Selects input 2 for V/GHz or External volts input. You cannot configure the V/GHz or External volts input port here. To configure V/GHz set Sensor > CalFactor > Source to V/GHz. To use the External Volts Input set Channel > Setup > Input to EXT V.

MODE (output ports only)

OFF (output set to ground) port 1 or 2

Analog OUT (analog scaled output) port 1 or 2 provides an output voltage proportional to the measurement.

RF Blanking (output 2 only) provides a logic level output during the ZERO process. This can be used to switch off RF from external sources.

PASS/FAIL port 1 or 2 logic level output

Signal channel A or B (port 1 or port 2) provides a real time output from the signal channel. Being real time, it shows modulation, etc., and is taken after the signal has been through range amplifiers. It is not directly proportional to the measurement.

Levelling A or B (range 1 or 2) (port 1 or 2). This is similar to the signal channel A or B outputs, except it connects to range 1 or 2 only of the signal channel. See below for more information on levelling.

ACMod output (port 1 only) is a TTL signal synchronized to the internal chopper (when used) of the signal channel. This signal can be used for synchronization with external sources or when viewing AC range (chopped) signals.

Levelling outputs

To allow the power meter to be used in a levelling loop, the signal channel output is available on the rear panel. The levelling loop will be broken every time the signal channel autoranges. To overcome this, the outputs of ranges 1 and 2 can be made directly available on the rear panel BNC connector. This feature is only available as a NON DRAWN option. It can be selected from the System > Rear Pane 1 > BNC menu - PORT 1 for sensor A and PORT 2 for sensor B. Levelling A(1) selects range 1 on sensor A. If the hardware is not available, 0 volts will be set on the appropriate output when selected.

For signal levels below -25 dBm on a diode sensor, the levelling outputs will not be valid as the signal channel operates in chopping mode below this level.

TTL LEVEL (Input port 1 only)

When in Readout or Power vs. Time operation mode, this selects the blanking input type, HIGH active or LOW active, you are providing. The blanking input will be used if the Trigger > Setup > ARMING is set to Blanking ON and the Sensor > Setup > Mode is set to Custom.

When in Profile operation Mode, the blanking input is ignored.

When in Source Sweep operation Mode, if the Blanking input is set to HIGH, the ML24xxA uses the digital input to sync to. Your sweeper must provide a Sequential Sync output which is connected to the digital input of the meter.

If Blanking input is set to LOW, the ML24xxA does not use the digital input and therefore can be connected to a sweeper which does not provide a Sequential Sync output. The ML24xxA will use the Horizontal Ramp input only.

Printer [PRNSEL]

Configures the rear panel printer port. Select from the listed compatible printers which include, but are not limited to, the following:

HP DeskJet 340
Canon BJC80

Other 300, 500, 600 Series and later HP printers are typically compatible.

For proper operation with the ML243xA, the Canon BJC80 printer must be set to the EPSON LQ emulation mode. Refer to the printer manual for instructions on setting the emulation mode.

Graphics

This menu presents additional graphic display controls:

CONNECT [GRCP]

This control is normally ON and causes the data between samples to be interpolated and lines drawn between sample points. When OFF, the sample points only are displayed as pixels.

TRACKING [GRTMM]

The number of scans of graph data between resetting the tracked min and max when in graph mode. Select SINGLE or INFINITE.

Note

These options allow either the min/max of each sweep to be displayed (single) or the conventional method for tracking variation of levels over an extended period of time (infinite).

REF LINE [GRFS]

Causes a dotted horizontal line to be drawn at the reference point on the graph screen; normally OFF.

PRE TRG% [GRPTP]

Percentage of the screen that displays pretrigger information at the best resolution available. The display shows an 'x' marking the trigger point on the time axis.

Data before the actual trigger event is not available. The trigger reference point (x) indicates the active trigger point after the DELAY setting in the System > Profile menu. Providing sufficient delay has been set, the PRE TRG% can be used to move this reference to anywhere on the screen. The amount of valid data displayed before the trigger reference point is dependent on the System > Profile > DELAY setting.

Secure [SECURE]

Normally OFF. When the system is powered on the ML243xA returns to the state it was in when it was powered off. This includes all of the offset tables, calibration adjust values, etc. If Secure is set to Clear memory, non-volatile memory is disabled and all stored values are reset to the factory defaults when the system is powered on. As long as this selection is set to Clear memory, the system will load the presets (see Appendix A, Section A-3) every time it is turned on.

Identity [*IDN, OI]

This selection will display the installed firmware version, the instrument serial number, and the instrument type (model number).

5-7 Cal/Zero Menu

The Cal/Zero menu establishes the 0.0 dBm reference calibration and zeroing of the sensors. Refer to Chapter 5 for specific procedures.

Zero/Cal

This function zeros and then sets the 50 MHz, 0.0 dBm reference of the connected sensor. In dual sensor systems with both sensors connected, sensor A or B must be selected.

Cal 0 dBm [CAL]

References the connected sensor to 0.0 dBm at 50 MHz. In dual sensor systems with both sensors connected, sensor A or B must be selected.

Zero [ZERO]

Zeros the connected sensor. Zeroing a power sensor compensates for noise and thermal EMF of the device under test. It is recommended prior to taking important power readings in the bottom 20 dB of a power sensor's dynamic range. In dual sensor systems with both sensors connected, sensor A or B must be selected.

RF ON/OFF [RFCAL]

Turns the RF calibrator ON or OFF.

Ext V [VZERO]

Zeros the rear panel multi-purpose BNC connector used for Volts per GHz connection (Analog Input). This will calibrate the units to read zero volts on this BNC. During this operation the connector should either not be connected to anything, or should be connected to a 0 Volt source.

The rear panel voltage can be viewed by selecting CHANNEL > INPUT > VOLTS, although this does not have to be selected in order for the function to operate.

This calibration is non-volatile and does not normally need to be performed. In the case of offsets being introduced by the user's setup, it is possible to leave the BNC cable connected to zero out system offsets, however the offset zero range is limited to approximately 100 mV.

Chapter 6 — Procedures

This chapter presents some common procedures for use with the ML243xA Power Meter. These procedures refer to the ML243xA front and rear panel connectors and front panel keys and menus as explained in Chapter 3, Connections, and Chapter 4, Front Panel Operation. The operator should be familiar with the front and rear panel layouts and with the use of the keys and menus before attempting these procedures.

6-1 Power Measurement

To perform a power measurement, follow these steps:

1. Connect the sensor(s) as described in Chapter 3, Connections.
2. Configure the meter for the application. Refer to Chapter 4, Front Panel Operation, for specific configuration options. The simplest operation is obtained with `SENSOR > SETUP > MODE` set to `DEFAULT`. Power readings are continuous with the default setting.
3. Zero the sensor(s) as described below.
4. Calibrate the sensor(s) as described on the following page.
5. Measure power.

6-2 Zeroing the Sensor

Zero the sensor before making power measurements, particularly when operating within the lower 20 dB dynamic range of the power sensor. If frequent low level measurements are being made, it is advisable to zero the sensor regularly.

To zero the sensor, connect it to the UUT (Unit Under Test) test port, and remove RF power from the connection to a level 20 dB below the tangential noise floor of the power sensor. For -70 to $+20$ dBm dual-diode power sensors, this level is less than -100 dBm.

It is preferable to leave the sensor connected to the UUT test port so that ground noise and thermal EMF are zeroed out of the measurement. Alternately, in order of preference, the sensor can be connected to:

- A grounded connector on the UUT,
- The ML243xA Calibrator connector,
- Disconnected from any signal source.

When a new sensor is attached, the message `SENSOR x NOT ZEROED` (where $x = A$ or B as appropriate) is displayed. If a sensor is removed and then reconnected, the message is not displayed.

The sensor can either be zeroed, or zeroed and calibrated in the same operation.

To zero the sensor without calibration, press the `Cal/Zero` front panel key and the `Zero` soft key, then select the appropriate sensor.

Note that if only one sensor is connected, the `A-B` selection is not displayed and the zeroing process begins immediately.

The message changes to **SENSOR x ZERO**. On successful completion of the zeroing operation, the buzzer sounds. Sensor calibration should be performed next.

If the sensor fails the zeroing operation, the message **SENSOR x ZERO fail nxxxx** is displayed. The hexadecimal error code 'nxxxx' indicates the detailed reason for the failure, which is usually due to excessive RF noise.

The sensors can also be zeroed using the GPIB **ZERO** command (see Chapter 6, “GPIB Operation”).

6-3 Sensor Calibration

Referencing power sensors to the ML243xA 50 MHz, 0.0 dBm calibrator is recommended. Sensors should be zeroed before being calibrated, either as a separate operation or in conjunction with calibration.

To reference the sensor, connect the sensor to the ML243xA 50 MHz, 0.0 dBm reference output connector labelled **CALIBRATOR** or another 50 MHz, 0.0 dBm reference.

When the sensor is first attached, the message **SENSOR x NOT ZEROED** (where x = A or B as appropriate) is displayed. Perform the sensor zeroing procedure described in Section 5-3 to zero the sensor.

To calibrate the sensor after zeroing, press the **Cal/Zero** front panel key and the **Cal 0 dBm** soft key, then select the appropriate sensor.

Note that if only one sensor is connected, the A-B selection is not displayed and the zeroing process begins immediately.

On successful completion of the calibration operation, the buzzer sounds.

If the sensor fails the calibration operation, the message **SENSOR x CAL 0 dBm invalid** is displayed.

Any error conditions encountered during calibration, for example the presence of extraneous noise or RF signals, will result in an error message on the front panel display.

The sensors can also be calibrated using the GPIB **CAL** command (see Chapter 6, GPIB Operation).

Note	When a Universal Power Sensor with option 1 fitted is changed from T-RMS mode to F-CW mode the user should perform a new zero/cal.
-------------	--

6-4 Sensor Zero/Cal

Sensors must be zeroed before being calibrated. The **Zero/Cal** function completes both operations in sequence.

To zero and calibrate the sensor, connect the sensor to the ML243xA 50 MHz, 0.0 dBm reference output connector labelled **CALIBRATOR**.

When the sensor is first attached, the message **SENSOR x NOT ZEROED** (where x = A or B as appropriate) is displayed.

Press the **Cal/Zero** front panel key and the **Zero/Cal** function key, then select the appropriate sensor. The message changes to **SENSOR x ZERO**. Note that the power meter automatically switches the reference calibrator **OFF** during the zeroing operation.

If only one sensor is connected, the A-B selection is not displayed and the zeroing process begins immediately.

On successful completion of the zeroing operation, the calibration process begins.

On successful completion of the calibration operation, the buzzer sounds and the message is cleared.

If the sensor fails either operation, the message `SENSOR x ZERO fail nxnnn` or `Sensor x Cal fail nxnnn` is displayed. The hexadecimal error code 'nxnnn' indicates the reason for the failure.

The sensors can also be zeroed and calibrated using GPIB commands (see Chapter 6, "GPIB Operation").

6-5 Performance Verification

The performance of the power meter's individual signal channel inputs can be verified using an Anritsu Range Calibrator. Contact your Anritsu Customer Service representative for more information.

6-6 Printer Connection

See Chapter 3, Connectors, for the location of the parallel port connector on the rear panel. Connect a parallel printer cable from the ML243xA rear panel 25-pin D-sub connector to the printer.

Select `System > Print` to begin printing. See Chapter 4, Front Panel Operation, for specific printer connector configuration options.

Printing can also be initiated in ML24XXA (native) mode using the GPIB PRINT command.

6-7 GPIB Remote Operation

The ML243xA Power Meter can be operated remotely through a General Purpose Interface Bus (GPIB) connection to a host computer/controller. See Chapter 3, Connectors, for the location of the GPIB connector. The GPIB connector is configured through the `System > Rear Panel > GPIB` submenu. See Chapter 4, Front Panel Operation, for specific GPIB connector configuration options that can be set from the front panel. Refer to Chapter 7, GPIB Operation, for a listing of the available GPIB commands.

If the ML243xA is addressed, and the Remote Enable and Local Lockout (REM and LLO) lines are not set, the front panel menus are still available, even if the unit is communicating. As long as the ML243xA is GPIB addressed, the GPIB status box will be displayed on the front panel whether the remote line is set or not.

If the GPIB box is on the screen and the system is not in a menu screen, and the system is in local mode (menus available), and no GPIB operations are pending, then pressing the CLR key clears the GPIB box off the screen.

Note

GPIB remote operation is not available when the ML243xA Series Power Meter is operating from the internal battery.

6-8 Serial Remote Operation

The ML243xA Power Meter can be operated remotely through the rear panel serial connector (See Chapter 3, Connectors, for the location of the serial connector). Whereas GPIB has restrictions on total cable length and cable length between instruments, RS232 serial communication is not as limited. The GPIB can also be prone to electrical interference and is not easily electrically isolated, while RS232 can be isolated using optical couplers. Serial interface remote operation can be useful if the testing is to be done in the presence of high electrical fields and like environments.

While most standard serial cables will suffice, a 9-pin null-modem serial interface cable is available from Anritsu as an optional accessory (part number 2000-1544). Note that the hardware handshake CTS and RTS lines are used to control the flow of data in and out of the power meter and must be available in the cable as hardware handshaking is always enabled. The DTR and DSR lines are connected together within the meter.

Note	Serial interface remote operation is not available when the ML243xA Series Power Meter is operating from the internal battery.
-------------	--

Table 6-1. ML243xA Power Meter Serial Connector Pinouts

PIN	SIGNAL
1	NOT USED
2	RX data
3	TX data
4	DTR handshake signal
5	signal ground
6	DSR handshake signal
7	RTS handshake signal
8	CTS handshake signal
9	NOT USED

The serial interface baud rate can be set using the System > Rear panel > RS232 menu selection or the RSBAUD command. Available baud rates are: 1200, 2400, 4800, 9600 (default), 19200, and 38400. Other parameters are predefined as: 8 bits, no parity and 1 stop bit and cannot be changed.

Commands are entered as with the GPIB interface, conforming to the command format for the operation (emulation) mode selected. All GPIB commands are supported. There are some additional commands, specific to the serial interface, that are prefixed with an exclamation mark (!). In the emulation modes, when running under GPIB, the measured data is always available when the meter has been addressed to talk. In serial mode, the meter cannot be addressed to talk, but measurement data can still be obtained by using the GPIB trigger commands TR1 and TR2 in the HP437 and HP438 emulation modes, and T and I in the HP436 emulation mode.

All GPIB type commands and command strings should be terminated with a new line character (0A hex). The special serial mode commands do NOT require a termination character.

Requested data is returned in the same format as with GPIB, but with a preceding 'R' and a terminating new line character. SRQs are available, and are output as SRQ message 'S' followed by a terminating new line character. When the SRQ message has been received, an "!SPL" command (equivalent to the GPIB serial poll) can be issued. The power meter will respond with the serial poll data message which is a single character preceded by 'P' and terminated by a new line character.

A device clear message !DCL can be sent to clear the power meter input and output message queues, and terminate any GPIB or serial actions pending.

At power on, factory reset, in response to the MODINIT command, and after the INIT key in the modem menu is pressed, the following sequences will be output:

1. +++ath\r\r
2. at&h1&r2x4v1q0f1s0=1e0\r\r

There will be a delay between the two sequences.

These sequences will initialize an attached Hayes-compatible modem. This is the only type of modem supported.

Note	It is recommended that there is only one serial command in each command string. Terminate each command with a newline character.
-------------	--

6-9 RS232 Modem Support

The ML243xA Power Meter can be operated remotely through a modem connected to the rear pane serial connector (See Chapter 3, Connectors, for the location of the serial connector) using the GPIB/RS232 command set. The menu selection System > Rear panel > RS232 > MODE must be set to EXT COMMS.

To initiate communications with the power meter from a remote computer, communications must be established between the two modems. Once this is done, the modems become transparent to the user, and GPIB/RS232 commands can be entered as if the power meter is connected directly to the remote computer.

The power meter can also be configured to automatically dial a specified number if one or more predetermined error conditions are met.

When an instrument state change occurs that initiates an AUTODIAL sequence, the power meter will send an escape sequence "+++" to the modem. It will then output commands to determine if there is a modem connected and, if there is, whether it is connected through to another modem. If a modem is found and it is not connected to a remote modem, the power meter will dial the number specified in the "phone number" field. When the connection to the remote computer is established, the power meter will send the serial SRQ message.

When an autodial sequence is initiated, different sets of characters will be seen on the remote PC depending on what is connected to the power meter serial port.

Note	Serial interface remote operation is not available when the ML243xA Series Power Meter is operating from the internal battery.
-------------	--

Table 6-2. Character Sequences

Connected Device	Character Sequence
Computer connected directly	"+++at\r\rS\n"
Modem offline from phone network Sequence will be seen if remote connection established	modem status data followed by "S\n"
Modem connected through to remote computer	"+++S\n"

GPIB/RS232 Modem Commands

The following table lists the GPIB/RS232 Modem Commands and the special serial interface only commands:

Table 6-3. Modem and Special Serial Interface Commands

Command	Parameter	Definition
!BYE		RS232-type command only, allows the remote PC to instruct the power meter to tell its local modem to hang-up. This ensures that when communication is completed, the modems at both ends of the line can be disconnected and the telephone line released.
!DCL		RS232 type command only. Clears all buffered GPIB/RS232 messages waiting to be processed. Clears all buffered GPIB/RS232 data waiting to be output. Stops any pending actions.
!SPL		RS232 type command only. Allows a GPIB type serial poll to be requested in response to an SRQ from the power meter. This will return the instrument status register and clear the SRQ bit within that register. The *CLS command should be used to clear the rest of the register.
MODDEL	<value>	Modem redial delay time, 1 to 10 minutes (default = 5 min.)
MODINIT		Initialize connected modem
MODLIM	<TRUE FALSE>	Autodial enable for limits failure
MODPH	<string>	Phone number - up to 40 characters
MODPWR	<TRUE FALSE>	Autodial enable for power on
MODRED	<value>	Modem redial count, 0 to 10 (default = 5)
MODRNG	<TRUE FALSE>	Autodial enable for range failure

The RS232-type commands (!BYE, !SPL and !DCL) do NOT require terminating. All other commands or command strings require a new line character to terminate.

Refer to the System Menu explanation in chapter 4 for information on using the front panel menus to configure modem operation. Refer to Native GPIB Commands in chapter 6, for information on using GPIB commands to configure modem operation.

Modem Compatibility and Commands

The ML243xA Power Meter firmware supports Hayes-compatible modems. The commands used are as follows:

Table 6-4. Modem Compatibility Commands

Command	Definition
+++	modem escape sequence
atz	reset modem to factory defaults
at&h1&r2x4v1q0f1s0=1e0	initialize modem for power meter use
atd "number"	dial "number"

Serial Interface Remote Operation Example

This section presents an example of Autodial using a terminal emulator on a remote computer (\n = newline, \r = carriage return).

1. Initialize local modem, using the same setup as the power meter:

```
at&h1&r2x4v1q0f1s0=1e0\r
```

```
&h1      transmit data flow control - use CTS
&r2      receive data flow control - use RTS
x4       full result code setting
v1       result codes in verbal mode
q0       result codes displayed
f1       local data echo OFF
s0=1     auto answer after 1 ring
e0       local command echo off
```

The modem should respond:

```
OK\n\r
```

2. Dial power meter:

```
atd<phone number>\r
```

When the modem finally connects to the power meter modem, the response will be:

```
CONNECT\n\r
```

There might be additional information after "CONNECT" but before the line termination characters.

3. The remote computer is now connected to the power meter. The power meter can now be asked to identify itself:

```
*IDN?\n
```

The response from an ML2438A operating in native mode will be:

```
RANRITSU,ML2438A,<serial number>,<firmware version>
```

4. To set a limit for channel 1 and to have the power meter autodial a remote computer when this limit fails, send the following sequence:

```
LLIM 1, -12DBM      Sets low limit on channel 1 to -12dBm
LLIMS 1, ON         Turn low limit testing ON for channel 1
MODLIM ON           Set meter to autodial when any limits fail
MODPH <phone       Set phone number to be auto-dialed
number>
MODRED 3            Set redial count to 3
MODDEL 2            Set delay between each attempt to dial to 2 min.
```

5. Disconnect from power meter and wait for limit failure:

```
!BYE                Instruct power meter to hang-up its modem
```

Wait at least 1 second.

```
+++
```

wait at least another second.

The local modem will now respond:

```
OK\n\r
```

The local modem can now be told to hang up using the command:

```
ATHO\r
```

Again the local modem will respond

```
OK\n\r
```

6. When a limits failure occurs, the power meter will instruct its modem to dial the previously set up phone number. As the connection is being established through to the remote computer, a sequence of status messages will be reported by the modem to the computer, ending with a final message of:

```
CONNECT\n\r
```

There might be additional information after "CONNECT" but before the line termination characters.

7. After connection has been established, the power meter will send an SRQ to the remote computer. The SRQ message is:

```
S\n
```

To determine what has caused the SRQ, the status register in the power meter must be read. The status register in the meter is an 8-bit register. There are two ways to do this.

a. Read the status register using the equivalent of a GPIB serial poll. Send the message:

```
!SPL
```

Note There is NO terminator to this message.

The power meter will respond:

```
Px\n
```

x is the ASCII character determined by the value in the meter status register.

x = "B" gives a status register value of 01000010 binary. Comparing this with the status byte description in Section 6-7 of the manual will show that the SRQ and limits error bits are both set.

b. Alternatively the status register can be read directly using the command:

```
*STB?\n
```

This will respond:

```
Ry\n
```

y can be up to 3 digits and is the decimal representation of the status register.

y="66" gives a status register value of 01000010 binary. Comparing this with the status byte description in section 6-7 of the manual will show that the SRQ and limits error bits are both set.

Once the status register has been read, it must be cleared to allow further SRQ messages to be sent. Before the status register is cleared, further autodial actions (limits failure or sensor range error) should be disabled to prevent any unnecessary autodial attempts by the meter when already connected to a remote PC. To clear the status register, use the command:

```
*CLS\n
```

6-10 Profile Operation Mode

The ML243xA Power Meter can be used to view signals in Profile, Readout, Power vs. Time and Source Sweep modes. This section describes setting up and viewing signals in the Profile mode. Profile mode allows the viewing of a single channel (1 or 2 as set up in the Channel menu) plotted against time.

To view the time profile of a signal, enter the PROFILE mode via SYSTEM > SETUP > MODE (toggles through READOUT, PROFILE and Power vs. Time). Parameters needed to set up a PROFILE display are:

Note	To operate the Universal power sensors in profile mode Option 1 must be fitted. Activate option 1 mode before selecting profile mode under the SENSOR > Setup OPTION FAST CW menu.
-------------	--

1. TRIGGER > SETUP provides access to a special TRIGGER configuration options. The default mode is CONTINUOUS which provides for a non-synchronized, oscilloscope type display. This type of display is useful for general monitoring of a signal and showing its variation over time. The settings for the DELAY and gate WIDTH provide the points at which the measurement is triggered and read out of the cursor. The other options are similar to other triggering modes.
2. SYSTEM > PROFILE sets up the channel (1 or 2) to be displayed and the time-axis, as well as the way that the data is displayed (for example, monitoring the minimum or maximum data over time). Note that in all cases, the PROFILE > CHANNEL selection (1 or 2) relates to a measurement channel set up in the CHANNEL menu, not directly to the A or B sensors.

Note	If the DATA HOLD mode is set to display min or max data, as opposed to the default (NORMAL), the display will continue to track the min/max until the DATA HOLD mode is returned to NORMAL.
-------------	---

3. SYSTEM > CONTROL provides control over the readout and CURSORS as well as the scaling of the display. From the CURSOR menu (using the << and >> arrows) the positions of the readout cursors can be adjusted. The cursors directly relate to the DELAY and gate WIDTH parameters in the TRIGGER > SETUP menu, but allow for visual movement of the parameters on the display itself. The TRIGGER > SETUP menu requires direct entry of the actual parameters when the timing criteria is known.

Note	Dynamic range is limited in Profile mode to DC ranges only. For maximum dynamic range, measured signals need to be repetitive (not single-shot) when profiling over less than 30 ms width. For collection periods longer than 30 ms, single-shot profiles can be measured over the full dynamic range.
-------------	--

Typical Setup

A typical situation with no triggering (CONTINUOUS):

1. Select SYSTEM > SETUP > PRESET to reset the instrument to the standard default conditions (see Appendix B for a listing of the system defaults).

2. Connect sensor A to the signal source.
3. Select **SYSTEM > SETUP** and press **MODE** to select **PROFILE**.
4. Press **CLR** or any other menu key to return to the display screen. The display now shows a power profile of sensor A on channel 1.
5. Press **SYSTEM > CONTROL** to get access to the cursor. Press **<<** and **>>** to move the selected cursor, and **SWAP** to select the other cursor.

Note

With a **CONTINUOUS** trigger such as this, there will most likely not be specific points of interest, so the movement of the cursors is rather arbitrary. If modulation is applied to the signal, or its power level altered, the signal should change on the display. The signal may not be visible if it is not in the default range which covers +20 to -50 dBm.

Scaling

In the example above, if the measured power signal is not visible because the power is too high or low, the scaling can be altered as follows:

1. Press **SYSTEM > CONTROL > more > SCALE**. There are now soft keys for **TOP** and **BOTTOM** dB levels, referring to the top and bottom of the screen, and **AUTO SCALE**, which will optimize the displayed graph.
2. Enter new values so that the measured power signal is visible. The **TOP** value must always be higher than the **BOTTOM** value.
3. When finished, press another soft key or **CLR** to return to the display.

Cursor Readout

To display the **CURSOR READOUT** box on the screen, press **SYSTEM > CONTROL > more > READOUT**. This is a toggle action and will display or remove the cursor data readout box from the display.

The readout shows a digital representation of data at the two cursor positions on the currently displayed channel, along with the differences in power (**D p**) and time (**D t**). The value of **D p** represents the selected cursor reading minus the other cursor reading, and **D t** represents the time difference between the two cursors. If **SENSOR > AVERAGING >** between **CURSOR** averaging is on, the average reading between the cursors is displayed at the bottom of the readout.

Note

If continuous trigger is selected, or the display is changing while trying to read the readout, select **TRIGGER > MANUAL** to stop the display update. The readouts are updated whenever the signal trace is updated, or if the cursors are moved. It is possible to link the movement of the cursors so they move at the same time. This is useful if measurements need to be taken at specific times between the cursors, as with channelled signals.

To link the cursors, select **SYSTEM > CONTROL > more > more > LINK CURSR**. When the cursors are linked, a line is drawn on the display connecting the two cursors and they will move together as one. This is discussed more fully in the **Triggered Measurements** section below.

Range Hold may be selected to limit dynamic range and prevent small range change disturbances on very high speed signals. Use Range Hold 1 for measurements down to -25 dBm, and Range Hold 2 up to -10 dBm. If the display update is turned off via GPIB, only the average is updated.

Triggered Measurements

Since non-triggered measurements are of limited use in the PROFILE mode, most applications require triggering. For example:

1. Provide a 1 kHz square wave modulated signal to sensor A, and set TRIGGER > SETUP > MODE to Internal A (Int A). This causes the PROFILE sweep to wait until a certain power level is present on the sensor before starting the sweep.
2. The DELAY and WIDTH parameters, as discussed above, are the positions of the two CURSORS. These can be set to specific locations; for example, if the signal is a 1 kHz square wave, setting the DELAY to 250 μ s places the cursor in the first cycle at the midpoint of one of the phases. Setting the WIDTH to 500 μ s sets the other CURSOR to exactly one half-cycle later, thus allowing display of the power levels in the two phases of the signal.

Note

If the modulation is turned off, then the trigger conditions will not be met and the sweep will not continue to be updated. This is useful to 'freeze' a display. To display a CW signal again, re-select CONTINUOUS trigger in TRIGGER > SETUP > MODE.

Note

In some conditions, it is useful to view triggered signals independent of signal levels. In these cases, provide an external trigger source into the rear panel TRIGGER input to trigger such a measurement.

3. The dynamic range in PROFILE mode is limited to the top two ranges (the DC ranges) of the meter. The lowest measurable power is approximately -40 dBm (diode sensors only). If the displayed range is restricted, check that RANGE HOLD is not applied.

Note

If RANGE HOLD 1 is applied, the lower limit will be approximately -30 dBm. If RANGE HOLD 2 is applied, the maximum level will be limited to approximately -10 dBm. In most triggered situations, range hold should be set to AUTO.

Note

The unique method of range changing applied in this mode means that the change between range 1 and 2 is effected in less than 2 ms. In most cases it is not noticeable, although there may be a slight discontinuity visible when using very small collection periods.

Note

Due to the range-change method, if a triggered signal is not repetitive the range change may not settle instantly, and the displayed result may be in error. This is generally true for x-axis times of less than 6 ms where it takes more than one pass to completely update the display.

Control of x-axis - Width of Profile - Sample Time

The control of the time-frames over which the PROFILE is gathered is very precise, but there are certain restrictions. With care it can be used to display the profile of signals down to typically 100 ns or better.

1. Select SYSTEM > PROFILE. The first two items in the menus have already been covered (selection of channel 1 or 2, and the method of display, min max). The last two selections control the data collection PERIOD (the time span of the window). The default period is 10 ms, and it can be adjusted down to 100 ns and below. If you are still displaying the 1 kHz square wave, enter a period of 3 ms. The display will zoom in to show more detail of the pulses.

Note	Thermal sensors have rise and fall times of <15 ms. Do not use a thermal sensor for fast signal profiles. Typical MA2470A and MA2440A Series sensors have rise times of <4 μ s. Fall time is typically <10 μ s, except at low power levels. Consider this when looking at fast signals.
-------------	---

2. Note that the cursors have remained at their set positions in time, that is, when altering the time axis the cursors stay at their set positions in terms of time - NOT POSITION ON THE SCREEN. This is very important when measuring specific points or peaks in a signal.
3. By altering the DELAY parameter, the PROFILE can be made to look at a segment of time long after or very close to the trigger point. That is, by setting the DELAY to 100 ms, the PROFILE will show the 100th pulse (and onwards) of a 1 kHz square wave. By setting to ZERO, the profile will show data immediately after the trigger has occurred. This is the DISPLAY TRIGGER DELAY and is denoted by a small 'x' on the PROFILE display. This marks the point on the display where data is taken at the time DISPLAY TRIGGER DELAY is placed. For example, for the 1 kHz square wave, the pulse edge would occur at the 'x' point whenever the DISPLAY TRIGGER DELAY is a multiple of 1 ms. The x-axis nomenclature always denotes this point with a time of ZERO (t=0), this allows the user to always consider time intervals relative to the display trigger which is usually the point of interest.

Note	For smaller values of display trigger delay, it is possible that the display will cover time intervals (on the left of the display) for which there is no data. In these conditions, the cursors are normally prevented from displaying data taken there as it will be in error (there is no data). The position of 'x' is nominally 10 % of the screen. This can be altered to any percentage the user requires in the SYSTEM > more > more > GRAPHICS preferences menu as the PRETRIGGER percentage. It can also be set to ZERO to remove pretrigger data and prevent confusion in cases of small display trigger delays. Profile can display A, B, or A-B measurements. Note that in the case of a ratioed measurement (A-B), the data is calculated as a straight dB difference (not a LINEAR mw difference). This is not the same as a MODULATED POWER AVERAGE measurement.
-------------	---

4. As well as the CURSOR readouts described above, the POWER AVERAGE method can be used to display the average power between the two cursors. This is performed as a TRUE AVERAGE and is the actual average of all the data points between and

including the cursors. By placing the cursors on the top of a pulse, the flat top power can be measured. By placing the cursors with a period of the pulse, the average power of the pulse is calculated. This is more accurate than a simple duty cycle calculation which makes assumptions about the pulse shape. Use the **SENSOR > AVERAGE** menu to enable this readout method.

Note	The display resolution is 200 pixels. Consider this effect on the resolution of timing data. For example, a 1 millisecond PROFILE window would have a cursor resolution on the display of 5 microseconds. The LIMITS test functions on PROFILE data, and can be configured to BEEP on fail conditions.
-------------	---

Advanced Triggering and Setup Options

The other aspects of triggering allow for fine tuning of the trigger conditions. This includes:-

- Selection of HIGH or LOW going edge in External TTL.
- Level setting on Internal A or B trigger, as well as polarity - HIGH or LOW going.
- ARMING via an External BLANKING input. When ARMING is set to Blanking ON, only samples taken when the rear panel Digital Input BNC is active will be averaged in the measurement. The polarity of the rear panel Digital Input BNC signal can be set (high or low) using the **System > Rear Panel > BNC > TTL LEVEL** menu setting. When ARMING is set to Blanking OFF, all samples are read.
- In the **SYSTEM > more > more > GRAPHICS** menu, there are options for:

(a) **CONNECT** points. With this ON (default) the data points are connected with vectors to resemble a real time trace. When OFF, the data points are displayed as data points only, with no connecting line. This can give a faster display update, however, it may be confusing as near vertical lines will have very few points defined within them.

(b) If Tracking min/max is selected for the CHANNEL being used for the PROFILE, it is possible to configure the tracking min/max to display the min and max values for all the data BETWEEN THE CURSORS. This provides easy access to peak values within a time-window; for example, the top of a pulse.

When set to SINGLE it is updated EACH SWEEP and reflects the min and max values only within that sweep.

When set to INFINITE, it maintains the min/max from the point it is started until it is reset, updating the MAX if it sees a HIGHER measurement within the CURSOR window, and updating the MIN readout if or when it sees a lower value than that which it has already. This option, in the SYSTEM menu, is only a preferences option and not the main control for the feature.

The control for the min/max remains in the CHANNEL menu (CHANNEL > SETUP>-more-> MIN/MAX > RESET). The user should select the way he wants to work and leave it. In most cases the SINGLE (default) is the most useful as it provides a continuously updated readout of the min and max points within the cursor window. The INFINITE setting is used when the results need to be collated over a large number of samples. In order to RESET the INFINITE configuration, use the CHANNEL menu.

Note	In the triggered modes, such as Internal A or B and External TTL, the SENSOR > SETUP > Range HOLD feature can still be applied to restrict dynamic range if required.
-------------	---

6-11 Source Sweep Mode

This feature allows the ML243xA Power Meter to be synchronized to an RF source using the Horizontal ramp (to Analog Input) output on the RF source. The ML243xA can also optionally use a Sequential Sync (to Digital Input) output on the RF source.

To enable the Seq Sync input for RF sources that do provide this output (the default), set the System > Rear Panel > BNC > Input Port 1 > TTL LEVEL to HIGH. This way the device will use both the Horizontal Ramp and Seq Sync inputs to sync to the sweep.

To disable the Seq Sync input for RF sources that do not provide this output, set the System > Rear Panel > BNC > Input Port 1 > TTL LEVEL to LOW. This way the device will only use the Horizontal Ramp to sync to the sweep.

Frequency Sweep Mode

When the sensor/cal factor source is set to V/GHz in Source Sweep mode, the start and stop voltages are assumed to be 0 and 10V, and the start and stop frequencies are taken from the System > Source sweep menu.

Calibrate the V/GHz setup by setting 0 and 10v and the frequencies (F1 and F2) that these voltages correspond to (sweep width). This method activates real-time cal factor correction on a swept basis (including any user cal factor tables) providing swept power measurements. Note that V/GHz output should not be used, as this limits the range of the signal applied to the meter when sweeping narrow widths. The fixed 0-10V ramp should be used to ensure correct sweep operation.

In normal operation, leave the CalFactor > SOURCE set to V/GHz as this instructs the meter to apply cal factor correction proportional to the input ramp, and ensures that the whole sweep of data is cal factor corrected in real time at every data point. If the CalFactor > Source is set to Manual or Frequency, a single frequency cal factor will be applied through the sweep (or a manually entered value). This may be useful for some applications where the sweep signal is used for others purposes (for example, power sweep, etc.).

Power Sweep Mode

In this mode the Ramp input is scaled to Start and Stop power settings. The start and stop voltages are assumed to be 0 and 10V, and the start and stop power settings are taken from the System > Source sweep menu.

Make sure the Sensor > CalFactor > SOURCE is set to Frequency or Manual. In power sweep mode V/GHZ is not used.

Source Sweep Graph

The annotation at the bottom of the screen is manually entered (there is currently no digital connection between the power meter and the source), and these can be entered through the SYSTEM > Source sweep > more- Start and Stop softkeys. Note that the scaling for the 10V ramp input is not directly applied to the bottom of the screen; the user is able to enter this directly and may include effects of frequency translation devices.

The other controls remain similar to the Profile graphic mode. SYSTEM > Control provides access to most other functions used during measurement, such as CURSOR movement and control, SCALING, and READOUT from the cursor. Note that the “between cursor average” has no meaning in Source Sweep mode, and in place of this the frequency of the measurement is indicated instead (x1 and x2). The readout is only updated while the system is sweeping.

Averaging may be applied by selecting SENSOR > Averaging and setting the STATE to ON. An averaging number may then be applied for either sensor independently. Averaging is ‘EXPONENTIAL’ in character so changes in response (for example, adjusting tuning of a filter) will gradually settle to their final measurement value over a period of time. A larger number will take longer to settle. Good measurements may be achieved down to -45 dBm (65 dB dynamic range) with an average value as low as 4. Values up to 64 and higher produce significantly lower noise readings. All averaging is performed on a true linear basis.

System > Source Sweep > Data Hold can be used to select the way in which data is plotted. Using Min/Max variation (both minimum and maximum) can be shown on the display. Using Max effectively provides a peak hold. If the display of swept power is not what is expected, check the setting of AVERAGE and the DATA HOLD mode in case it is affecting the data processing.

Note

As with other graphic modes, improved speed can be achieved in ATE systems by disabling the graphic draw function for the LCD through the menus using SYSTEM > more > more > Graphics > CONNECT. Setting CONNECT to OFF displaces the line-drawing between samples, and improves update rate. Similarly, for ATE systems, the READOUT should be disabled for fastest throughput as this can all be handled within the controller (PC). Sensor range hold is not available in this mode of operation as auto ranging is selected.

Using an Anritsu Synthesizer

The ML243xA can be connected directly to the Anritsu MG3690- and 68/69000-Series Synthesized Signal Generators using a special RS232 cable (Anritsu part number C37399). To use this remote connection, the System > Setup mode must be set to Source sweep, and the System > Rear panel > RS232 mode must be set to SOURCE IF. The RS232 mode can also be changed using the GPIB command RSMODE.

When set up in this manner, all sweep frequency and power parameters will be communicated from the source to the meter. If the source frequency power level or the frequency itself is changed, the source sweep display will be updated where appropriate.

Using the MG3690-Series Synthesizer

The MG3690-series synthesizer can be used for source sweep mode. Option 06, Analog sweep, must be installed in the synthesizer for this functionality.

Using the 68/69000-Series Synthesizer

To communicate with an Anritsu 68/69000-series synthesizers, the synthesizer model and firmware must be later than the levels shown below for each model.

680xxB - 3.39,	681xxB - 3.44,	682xxB - 2.41,	683xxB - 2.50,	680x5B - 1.26,
681x5B - 1.32,	682x5B - 1.30,	683x5B - 1.34,	690xxA - 1.21,	691xxA - 1.26,
692xxA - 1.26,	693xxA - 1.35,	690x5A - 1.21,	691x5A - 1.24,	692x5A - 1.24,
693x5A - 1.31				

Contact your nearest Anritsu Service Center for a firmware upgrade if necessary.

6-12 Power vs. Time Mode

The ML243xA Power vs. Time mode is a graphical chart display of one of the display channels, as selected in the SYSTEM > PWR vs. TIME menu. The triggering setup is as set for Readout mode operation.

Power vs. Time mode provides a chart display on a timed basis where the x-axis of the graph is defined in units of time. The user specifies the sweep period and, within this sweep period, each pixel depicts all the measurements taken within a 200th of the sweep period.

The data can be displayed as a maximum value only, a minimum value only, maximum and minimum values, the average of all the readings during the time slot period, or the latest measured value. These display modes are selected in the SYSTEM > Pwr Vs Time menu, DATA HOLD representation. Measurement setup, i.e., trigger, etc., is selected the same way as in Readout mode. The minimum sweep time is 1 minute, and the maximum sweep time is 24 hours.

6-13 User Cal Factors

All MA24XXA-D Power Sensors have an internal EEPROM containing correction and calibration factors programmed into the sensor at the factory. This “cal factor” data is used when the power meter is set up to use frequency or volts per GHz calibration factors. The correction is in linearity (across the dynamic range) and sensitivity (across frequency).

The ML243xA has the capability to define sets of calibration factor data and store them in the sensor. A user-defined cal factor table can be used on its own, or in conjunction with the factory-defined cal factor table. Linearity correction is not affected provided the meter cal factor frequency is set correctly.

Note

This feature is also available when using Anritsu MA4700A/ MA4600A sensors with the Anritsu MA2499B Sensor Adapter. Since the MA4700A/ MA4600A sensors do not contain an EEPROM, the user cal factors are stored in the MA2499B adapter EEPROM.

Depending on the amount of factory calibration data stored in the sensor, there can be up to 10 user-defined cal factor tables. A “user” cal factor table consists of up to 90 frequency/cal factor data pairs for sensors up to 40 GHz or 110 frequency/cal factor data pairs for sensors up to 50 GHz, plus a 7-character identity text string. User cal factor tables are fully interpolated, and can be used to apply correction for attenuators placed in front of the sensor. In this situation, determine the attenuation factors and use them in addition to the Factory cal factors. The number of frequency/cal factor data pairs in the factory defined table depends on the sensor being used.

The cal factor tables for a particular sensor are not maintained by the meter, but are held in the sensor. This means that when moving a sensor (perhaps with an associated attenuator or calibration record) from one meter to another, the calibration stays valid. It is not necessary to re-setup the new meter.

Note	A * in the displayed status box by the Cal Factor indicator, signifies User Cal Factors are active. User Cal Factors are maintained in the sensor.
-------------	--

The first time a sensor is used with the ML243xA, a slight delay may be experienced when the sensor is first plugged in. This is caused by the firmware preparing the sensor to accept user cal factor tables. After first initialization, user cal factor tables will have only a single entry at 50 MHz, 100 %.

Cal factor tables are accessed through the Sensor > CalFactor > USE TABLE front panel menus (Chapter 4), or through GPIB commands.

Example Procedure

Use the key sequence Sensor > Cal Factor > EDIT to get to the table edit menu. Use the TABLE key to select the table, then the EDIT key to edit that table. Press the INSERT key to enter frequency and cal factor data pairs.

For example, in order to enter the frequency/cal factor pairs 1 GHz @ 100 %, 2 GHz @ 101 %, 3 GHz @ 98 % and 4 GHz @ 98 %, step through the keys in the following sequence:

```
FREQ, 1, GHz.Entr  
FACTOR, 100, %  
FREQ, 2, GHz. Entr  
FACTOR, 101, %  
FREQ, 3, GHz. Entr  
FACTOR, 98, %  
FREQ, 4, GHz. Entr  
DONE
```

The frequency/cal factor pairs can be entered in any order. Each time a new frequency is entered, a new data pair is formed. As the data pairs are entered, they are sorted into frequency ascending order.

Readout Mode

In Readout mode, the bottom text line in the Status box indicates what type of calibration factors are being used. At any time, if anything other than the factory supplied cal data is applied, the Status box display shows a warning “*” sign on the Cal Factor line to show that non-standard calibration is being applied. For example:

CAL F = frequency cal factors using factory defined table

CAL V = volts per GHz cal factors using factory defined table

CAL M = manual cal factor

CAL *F = frequency cal factors employing a user defined table

CAL *V = volts per GHz cal factors employing a user defined table

This is because the application of user cal factors can completely change the calibrated response of the Sensor.

6-14 Optimizing Readings

This section presents information on how to get the fastest readings from the ML243xA Power Meter when operating under GPIB control. Refer to Chapter 6, GPIB Operation, for specific command descriptions.

Measurement speed depends greatly on the type of measurements being taken, the power level, and the amount of settling used.

Note	All results shown in this section are from DOS programs running on a 200 MHz controller using IEEE 488.2 GPIB function calls. The timings (readings/second) presented in this section are for illustrative purposes only.
-------------	---

Using the default system set up (system preset), the "O 1" command is used to retrieve one reading from channel 1 ten times (channel 1 = Sensor A).

C code example:

```

/* Reset the unit */
Send(0, 13, "*RST", 4L, NLEnd);

/* Ask for 10 readings */
for(i=0; i<10; i++)
{
Send(0, 13, "O 1", 3L, NLEnd);
Receive(0, 13, buffer[i], 20, STOPend);
}
    
```

Table 6-5. Power Levels and Reading per Second

Settling (%)	Power Level (dBm)	Readings/s
0.1	0	150
0.1	-30	150
10.0	-30	150

There are, however, methods of improving the speed of the measurement without having to change the power level or settling time.

DISP ON/OFF command

Using the DISP command the readout display can be turned OFF, yet data can still be acquired from the readout channels.

C code example:

```

/* turn display off */
Send(0, 13, "DISP OFF", 8L, NLEnd);

/*Ask for 10 readings */
for(i=0; i<10; i++)
{
Send(0, 13, "O 1", 3L, NLEnd);
Receive(0, 13, buffer[i], 20, STOPend);
}
    
```

Table 6-6. Power Levels and Reading per Second

Settling (%)	Power Level (dBm)	Readings/s
0.1	0	160
0.1	-30	160
10.0	-30	160

The 0.1 % settling on -30 dBm power level results were not improved because of the amount of time needed to settle to 0.1 % on -30 dBm.

FAST ON/OFF command

Using the FAST command limits the types of measurements that can be taken. As some processes are turned off, higher measurement speeds can be achieved. FAST will not operate when sent via RS232. When THE FAST ON command is selected, the readout display is also turned OFF.

Note Using FAST mode only increases speed when asking for one measurement at a time, using the 'Receive' command.

C code example:

```

/* send fast mode ON*/
Send(0, 13, "FAST ON", 7L, NLEnd);

/* Setup the power meter into talk addressed. In this mode*/
/* we can read from power meter without readdressing each */
/* time. */

Receivesetup(0,13);

/* Now read 10 readings */
for (loop = 0; loop < 10; loop++)
{
  RcvRespMsg(0,buffer,STOPend); }

```

Table 6-7. Power Levels and Reading per Second

Settling (%)	Power Level (dBm)	Readings/s
0.1	0	150
0.1	-30	150
10.0	0	610
10.0	-30	250

The 0.1 % settling on -30 dBm power level results were not improved because of the time needed to settle to 0.1 % at -30 dBm.

Using Buffered Requests

Using the buffered Output channel ON command, even faster measurement speeds can be achieved. By using the ON command instead of the O command x number of times, extra processing is removed, resulting in improved speed.

Note Using FAST mode here will not increase the speed as this mode only works when asking for one measurement at a time (i.e., the 'O' command only.)

C code example:

```
/* Reset unit and ask for 200 buffered readings n channel 1 */
Send(0, 13, "**RST; ON 1, 200", 15L, NLEnd);

/* use a large buffer size (4K for 200 readings) */
Receive(0, 13, buffer, 4096, STOPend);
```

Table 6-8. Power Levels and Reading per Second

Settling (%)	Power Level (dBm)	Readings/s
0.1	0	216
0.1	-30	202

Changing Measurement Modes

By changing the sensor measurement mode to Custom, the ML243xA can be precisely configured to meet the needs of the specific application.

In this example, the Trigger Gate Width has been reduced to 1 ms, Channel 1 is set to Sensor A, and Channel 2 is off.

C code example:

```
/* reset unit. Custom measurement mode, 1 ms TRGGW */
/* Auto averaging Sensor A Channel 2 off*/
/* Use FAST mode*/
Send(0, 13, "**RST; FAST ON; SENMM A, CUSTOM; TRGGW 1 ms", 51L,
NLEnd);

Receivesetup(0,13);

/* Fast mode, therefore do not send '0 1' for data, just read.*/
for(i=0; i<10; i++)
RcvRespMsg(0,buffer,STOPend);
```

Table 6-9. Power Levels and Reading per Second

Power Level (dBm)	Readings/s
0	240
-30	240

An Example Program in C

```
#include <stdio.h>
/* include the NI 488.2 GPIB include file */
#include "DECL.H"
/* LINK with MCIB.LIB */
/* Compiled with BorlandC++ 2.0 */

void main()
{
    int i;
    char buffer[10][20];
    /* clear buffer */
    memset(buffer,0,200);
    SendIFC(0);
    if ( ibsta & ERR )
    {
        printf("GPIB error\nibsta: %0x\niberr: %i\n\n", ibsta,
            iberr);
        exit(1);
    }

    /* Setup ML2430A at address 13 */
    /* FAST mode (output readout channel 1)
    Send(0, 13, "*RST; FAST ON", 13L, NLEnd);

    /* Loop 10 times and store readings */
    for(i=0; i<10; i++)
        Receive(0, 13, buffer[i], 20, STOPend);
    /* display readings.. */
    for(i=0; i<10; i++)
        printf("Reading %i = %s", i+1, buffer[i]);
}
```

6-15 Operator Maintenance

The ML243xA does not require any operator maintenance. All repairs must be performed by qualified service personnel only.

Software Loader Instructions

The latest version of the firmware can be downloaded from the Anritsu website at <http://www.anritsu.com>

1. Copy appropriate self-extracting zip file to empty directory.
2. Double click on zip file icon. This will extract all files to the current directory.
3. Connect PC com port 1 or 2 to power meter using Null modem cable (Anritsu p/n 2000-1544). As a minimum you need TX & RX (pins 2 & 3) swapped and RTS & CTS (pins 7 & 8) swapped.
4. Ensure the Powermeter is powered-on.
5. Put power meter into bootload mode. Select SYSTEM> more> more> more>. Press the blank softkey twice, and select "BOOTLOAD". The power meter is now in bootload mode, waiting for input from the PC.
6. If using COM1 for bootload, double click on DOS batch file icon "Q_BOOTQ1" for ML243xA or "Z_BOOTQ1" for ML240xA. If using COM2 then use files ending in Q2.
7. If PC will not run dos batch files, open DOS window in the directory where the files are stored and type: "bootload q 1 quart_fl" return. If using com2 change 1 to 2 in the command line. If loading ML240xA, change quart_fl to zippy_fl.
8. While loading, the powermeter screen will turn off, and the PC screen will show the files being loaded, and a counter indicating progress.
9. Wait approximately 5 minutes for the bootload process to complete.
10. When finished, the power meter will restart, and the PC program will indicate that it has finished.

Note	Do not remove power from the product while loading firmware. This is not recoverable without returning the power meter to a customer service centre.
-------------	--

Chapter 7 — Measurement Examples

7-1 Example 1: Standard CW Power Measurements

This first example will explain everything you need to know about the ML2430A Series Power Meter when making standard carrier wave power measurements. However, the power meter is capable of much more and examples 2 to 11 explore its functionality in greater depth.

1. Switching on

Turn the ML2430A on using the front panel ON/OFF button.

2. Preset the meter to a known state

A Preset returns the ML2430A to its default settings. It is recommended that this is carried out before each new measurement type and whenever the meter is reconfigured for a new measurement. To preset, press [System] > [Setup] > [-more-] > [PRESET] > [Factory]

Having performed a Preset, the Measurement screen is displayed:



Figure 7-1. Measurement Screen

Select the correct power sensor for your measurement. Consider points such as power range, frequency range, connector type, and speed of response required.

See the appendix for a table of power sensor model numbers, power and frequency ranges.

3. Zero the sensor

Zeroing the power sensor removes any residual DC offset on the sensor/meter combination. After a zero the measurement noise floor is minimized. It is recommended that you always zero the sensor at the beginning of each measurement session and prior to taking important power readings in the bottom 20 dB of its dynamic range.

Anritsu recommends that during Zeroing, the sensor is connected to the device under test having ensured it is not emitting any power (*see* 5. Connections). If this is not possible, then the sensor should be zeroed to the CALIBRATOR socket on the ML2430A front panel. The third option would be to Zero with the sensor in free space i.e. not connected to anything.

Press [Cal/Zero] > [Zero]

The ML2430A will take a few seconds to perform the Zero and will beep when finished. The Measurement screen is displayed and returns a value of approximately -75 dBm for a standard diode sensor or -40 dBm for a thermal sensor.

4. Calibration

At the beginning of a measurement session, it is good practice to calibrate the sensor. Connect the sensor to the CALIBRATOR connector on the ML2430A front panel and press [Cal/Zero] > [-Cal 0 dBm].

The ML2430A will take a few seconds to perform the calibration and will beep when finished.

To validate that the meter is working correctly, you may choose to now measure the 0 dB calibration signal. Press [Cal/Zero] > [-more-].

Check that the left-hand soft key reads RF ON. If it reads RF OFF, press [RF ON] to toggle the setting to RF ON. A correctly functioning instrument will return the following screen:



Figure 7-2.

5. Connections

Connect the power meter to the device under test via the sensor. Ensure:

- you are using the appropriate sensor for the measurement you wish to make
- the sensor is fitted with the correct connector for the device you wish to test.

See the appendix for a table of power sensor model numbers, power and frequency ranges.

Anritsu do not recommend the use of adapters between the power source and the sensor since this can introduce measurement errors.

6. Applying a calibration factor

The accuracy of a measurement is affected by the frequency response of the individual sensor. To correct for the sensor frequency response you can enter into the meter the calibration factor for the measurement frequency. This calibration factor data is stored in an EEPROM in the power sensor body.

Press [Sensor] > [Cal Factor].

The following screen is displayed.



Figure 7-3.

Some text on the screen appears in upper case. This indicates which soft key to select to change the item’s setting. For example, to change the Input signal FREQUENCY, press the FREQ soft key.

Press [FREQ] and using the keypad, input the Input Signal Frequency of the device under test. The soft keys at the bottom of the screen will now change.

Depending on the frequency type, press [GHz.Entr] or [MHz.Entr]. To return to the Measurement screen, press any hard key.

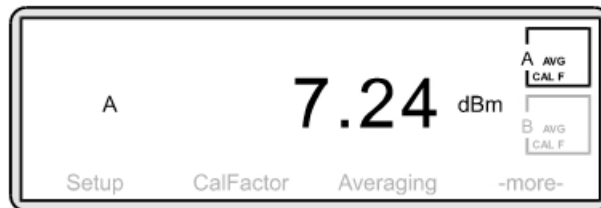

Figure 7-4.

You are now measuring power. Your Measurement screen should now look something like this:

However, you may wish to modify the measurement in the following ways:

Changing the way measurement units and decimal resolution are displayed on the screen.

The default setting for the ML2430A is to display units in dB[m] and resolution to two decimal places. To change this, press [Channel] > [Setup].

To change the display units, press [UNITS] and toggle the setting by repeatedly pressing the soft key until the measurement unit you require is displayed. Available units are; dBm, W, dBmV and dBmV.



Figure 7-5.

To change the resolution, press [-more-] to display further soft keys and then press [RESOLUTION]. Toggle this setting until the resolution you require is displayed.



Figure 7-6.

7. Keeping track of minimum and maximum measurements.

You may have a requirement to track a device’s highest and lowest power measurements over time. Press [Channel] > [Setup].

The Channel Set Up screen is displayed. Press [-more-] to display further soft keys. Press [MIN/MAX]. The display changes to:



Figure 7-7.

You will notice the new line “RESET tracked min/max.” The Min/Max feature can be reset to record a new time frame at any point — just select [RESET] from the Channel Set Up options. To return to the Measurement screen, press any hard key.

The Measurement screen now displays a minimum and maximum range.

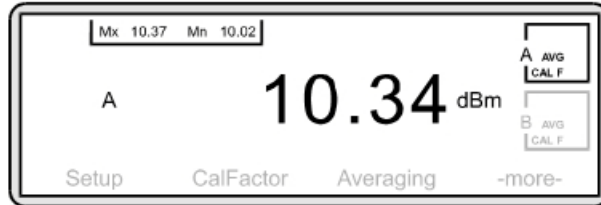

Figure 7-8.

8. Correcting for the effects of an Attenuator or Coupler.

Offset values can be either specified in dB or can be obtained from five different Frequency-against-dB Offset Tables. To enter an offset value press [Sensor] > [-more-] [Offset].

The Sensor Offset screen is displayed.



Figure 7-9.

To apply an offset, press [TYPE]. Toggle this setting until the offset you require is displayed (see below).

Fixed Offset: If you require a fixed offset, press [TYPE] until “Fixed” is displayed. The soft keys at the bottom of the screen will now change. Press [VALUE] and using the keypad, input the dB value of the offset. Press [ENTER].

Offset from Table: Tables enable an offset to be applied that is frequency dependent. The table must be entered into the memory of the meter before it can be applied. See the Miscellaneous Features section of this guide for further information.

To return to the Measurement screen press any hard key.



Figure 7-10.

Note that box A in the top right hand corner of the screen now indicates that an OFFSET has been applied to the Sensor.

9. Using measurement limits

When using limits, if the power from the device under test falls outside a pre-defined range, the meter will inform you — visually, audibly or both.

Press [Channel] > [LIMITS]

The following screen is displayed:

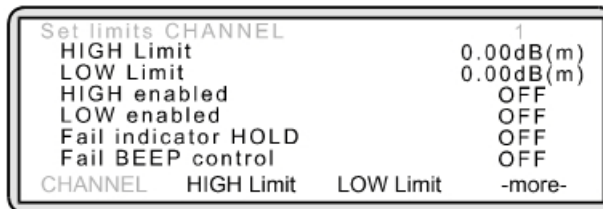

Figure 7-11.

- [-more-] To access further soft keys.
- [HIGH Limit] The upper test value. If the power remains below this value, the Measurement screen will show PASS alongside display. If the power rises above this value, the screen will show FAIL.
- [LOW Limit] The lower test value. If the power remains above this value, the Measurement screen will show PASS alongside the display. If the power drops below this value, the display will show FAIL
- [HIGH State] This setting is automatically set to ON when an upper test value is entered. Toggle the setting on or off.
- [LOW State] This setting is automatically set to ON when a lower test value is entered. Toggle the setting on or off.

- [FAIL HOLD] When set to ON, if the power falls outside the range defined in High Limit and/or Low Limit the Measurement screen will show FAIL alongside the value. This will remain until the setting is toggled off.
- [BEEP] When set to ON, if the power falls outside the range defined in High Limit and/or Low Limit, an audible beep will sound. If [FAIL HOLD] is ON and a fail has occurred, a beep will sound every second until [FAIL HOLD] is turned off or you press [CLR].

10. Defining a relative power measurement

You may have a requirement not to measure the actual power output of a device but to express the current power relative to a previously measured power. To do this, it is necessary to define an absolute reference value.

Let us assume the actual power output at a given time is 10 dBm. You want to track any change in power above or below 10 dBm. Press [Channel] > [Rel 1]

The display will change to 0.00 dBr and will measure future power LESS the 10 dBm absolute value.



Figure 7-12.

Note that the measurement unit has changed to dBr.

If at any point you wish check the absolute value stored in the meter, press [Rel 1] again. If at any point you wish to change the absolute value, press [Rel 1] for approximately 2 seconds. This will then replace the stored absolute value with the current measurement.

To check the absolute value, press [Rel 1] once. To re-define the absolute value, press [Rel 1] for approximately 2 seconds.

7-2 Example 2: Measuring Modulated Carrier

The Anritsu power sensors MA2440A and MA2470A are fast responding diode sensors. When measuring signals with an average power greater than -25 dBm and an amplitude modulation component, all diode sensors will normally give incorrect measurement results. This is because the diode is not detecting in its square law region.

A special feature of the Anritsu diode sensors and power meters is the ability to correctly measure amplitude modulated carriers with average powers greater than -25 dBm. This is possible because the diodes are fast responding and have a large video bandwidth. This means they demodulate signals that are within this bandwidth.

This property is used in the modulation average mode to give accurate average power readings at high power levels with modulated signals.

Modulation average is not required when making measurements with thermal sensors.

To change the measurement mode, press [Sensor] > [Setup] > [MODE].

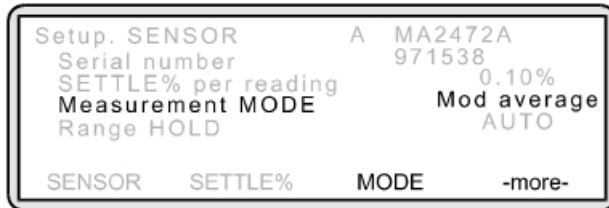

Figure 7-13.

The Measurement screen will now display a stable reading. A modulation icon reminds you that this mode is active.



Figure 7-14.

7-3 Example 3: Optimizing Measurements at Low Power Levels

When measuring power levels in the bottom 20 dB of a sensor's dynamic range, Anritsu recommends that prior to the measurement, you perform a Zero. If possible, this should be done with the sensor connected to the device under test (having first ensured it is not emitting any power).

When measuring power, readings are subject to a certain amount of noise. To minimize this, averaging increases as the power level reduces. However, at the bottom 20 dB of a sensor's dynamic range, this effect of noise increases. The meter automatically increases the amount of averaging for low power measurements. However, you may choose to select a high level of averaging. This will be at the expense of measurement speed. To do this, it is necessary to move from Automatic Averaging (the default factory setting) to another method — either Moving or Repeat.

Moving mode: This mode allows you to manually select the number of averaging readings taken (between 1 reading and 512 readings) regardless of the power level. A reading rate of 512 indicates the highest level of averaging and is recommended when measuring at low power. The display is continually updated whilst averaging.

Repeat mode: This mode is similar to Moving Average but the display is only updated once the specified number of readings has been taken. One drawback to this mode is that if the reading rate is set to 512 and the power level changes before all readings have been taken, the display will not reflect the true input power.

1. Changing the averaging mode

To change the averaging mode, press [Sensor] > [AVERAGING].

The following screen is displayed:

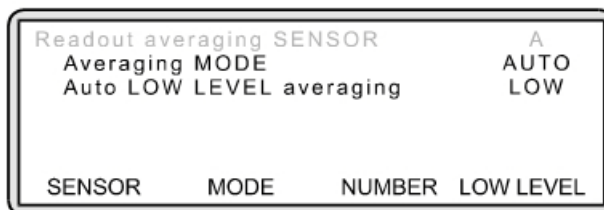

Figure 7-15.

This screen reflects the default factory setting. To change the averaging mode, press [MODE]. Toggle this setting until the mode you require is displayed.

To enter a reading rate, press [NUMBER] and using the keypad, input the rate (between 1 and 512). Press [ENTER].

2. Apply Automatic Low Level averaging.

Automatic Low Level averaging smooths the display but only if the reading is comparatively stable. The default factory setting is LOW and will take out fluctuations of ± 0.01 dB.

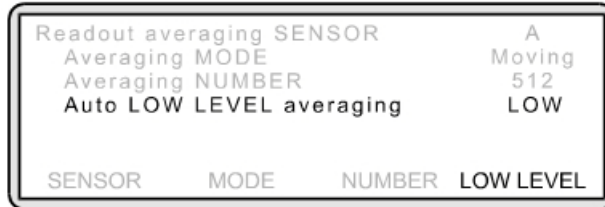

Figure 7-16.

To change this setting to MEDIUM (± 0.02 dB), HIGH (± 0.05 dB) or to turn it OFF, press [LOW LEVEL].

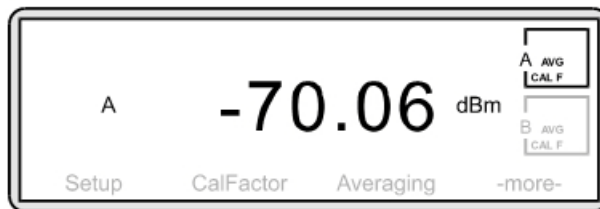

Figure 7-17.

Typical display for measurement of low power levels.

7-4 Example 4: Using Both Channels

In the previous examples, measurements have been made on only one channel — channel 1. However, it is possible to measure power on two channels. Possible applications for this feature when using only one sensor might be to display the measurement in dBm on channel 1 and Watts on channel 2 or with two sensors to measure power at different points in a test system.

When two channels are in operation, the displays are aligned one above the other.

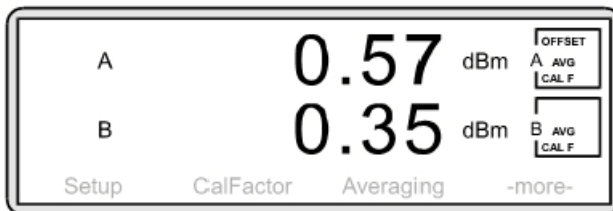

Figure 7-18.

To activate channel 2, press [Channel] > [Setup].

The following screen is shown:

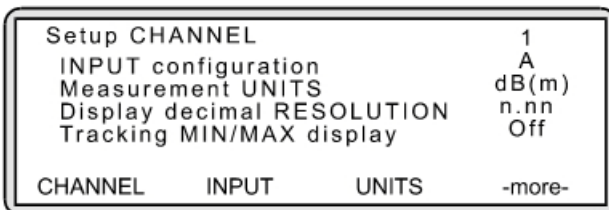

Figure 7-19.

Press [CHANNEL]. The screen now shows the configuration for channel 2. Note that the Input Configuration is set to OFF and is therefore inactive.

In order to activate channel 2, it is necessary to specify the type of input (sensor, combination of sensors or rear panel BNC input) that will be used. This will vary depending on the model of power meter you are using. To allocate an input for channel 2, press [INPUT]. Toggle the setting until the input type you require is displayed.

Table 7-1. Input options for the ML2437A

Input	Meaning
A	Take input from sensor A
External Volts	Take input from rear panel BNC, “Input 2, Analog”
OFF	Default value – Channel is inactive

Table 7-2. Input options for the ML2438A

Input	Meaning
A	Take input from sensor A
B	Take input from sensor B
A-B	Subtract sensor measurement B from sensor measurement A and display result on current channel *
B-A	Subtract sensor measurement A from sensor measurement B and display result on current channel *
A/B	Divide sensor measurement A by sensor measurement B and display result on current channel.*
B/A	Divide sensor measurement B by sensor measurement A and display result on current channel.*
External Volts	Take input from rear panel BNC, "Input 2, Analog"
OFF	Default value – channel is inactive

* These ratios are expressed in either logarithmic or linear terms but the mathematical calculation is always performed on the linear values. Please refer to the Operation Manual for further details.

When using the Channel Menu options to change settings such as Units, Resolution, Min/Max etc. make sure that you are effecting the changes on the correct channel. Change from channel 1 to channel 2 by using the [CHANNEL] soft key.

A preset will return the power meter back to its default setting i.e. one channel only.

7-5 Example 5: Using Two Sensors

The Dual Input ML2438A allows for two sensors to be used simultaneously with the Measurement screen showing both readings one above the other. One possible application for this feature might be to measure the forward and reflected power on an antenna.

Channel 1 might be configured to show the measurement from sensor A with channel 2 showing the measurement from sensor B. The resulting Measurement screen may look like this:

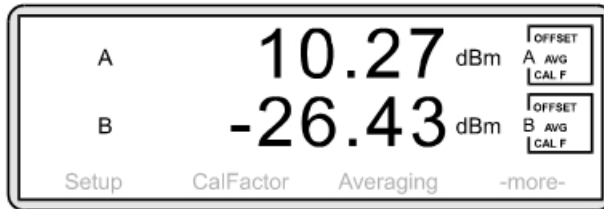

Figure 7-20.

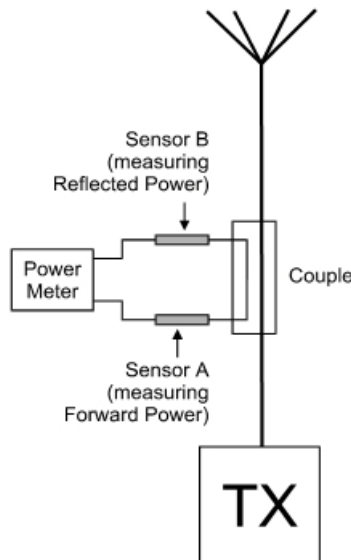

Figure 7-21.

An offset has been applied to compensate for the coupling factor of the through line coupler. In this example, sensor A is allocated to channel 1 and sensor B is allocated to channel 2. This allocation can be changed as shown in Example 4.

When using the Sensor Menu options to change settings such as Mode, Calibration Factor, Averaging etc. make sure that you are effecting the changes on the correct sensor. Change from sensor A to sensor B by using the [SENSOR] soft key.

Additional soft keys are included in the Cal/Zero Menu options — [Sensor A] and [Sensor B]. Select as appropriate.

After a Preset, channel 1 is allocated to sensor A and channel 2 is inactive.

7-6 Example 6: Gain Compression Measurement

A common application for a two input power meter is for gain compression measurements on amplifiers. In this example, we will measure the 1 dB compression point for an amplifier with 20 dB gain.

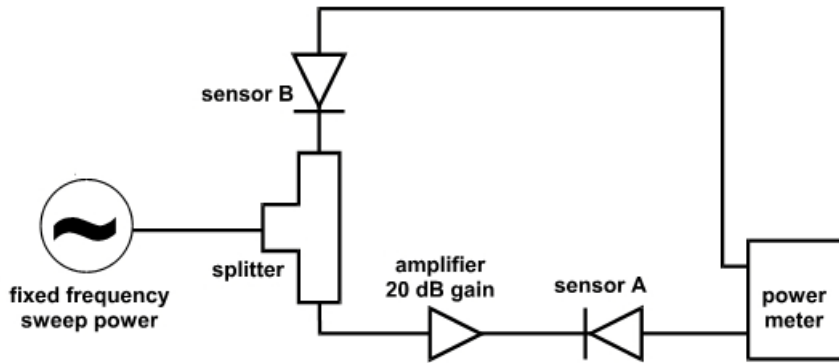

Figure 7-22.

Connect your measurement system as shown above. Allocate sensor A to channel 1 and sensor B to channel 2 (see Example 4 and 5) The signal source should be set to a suitable CW frequency to test the amplifier. Follow the procedures described in Example 1 to zero and calibrate the sensor and to enter the correct calibrator factor frequency for this measurement. The source power level should initially be set to a power at which the amplifier is on its linear, small signal gain region. In this case, -30 dBm. Your measurement screen may look something like this:

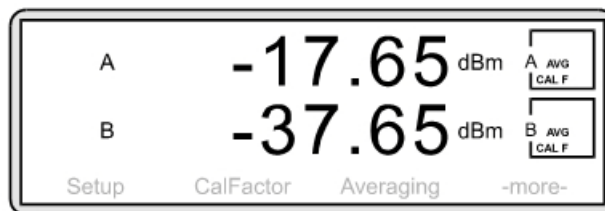

Figure 7-23.

A is displaying the output power of the amplifier. B is displaying the input power to the amplifier. (Note a signal splitter has a nominal path loss of 6 dB.)

We can display the gain of the amplifier directly if we set channel 1 to A/B (see Example 4). Press [Channel] > [Setup] > [Input].

Your Measurement screen will now display the following:

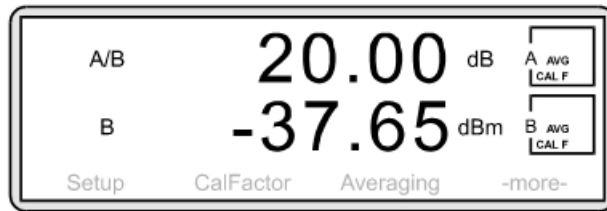

Figure 7-24.

Note the small signal gain of the amplifier. Now increase the signal source power slowly. When the amplifier begins to compress the displayed gain will start to decrease. Increase the source power until the gain has dropped by 1 dB, in this example to 19 dB.

Channel 2 now shows the input power at which the amplifier is in 1 dB compression. To display the amplifiers output power at 1 dB compression, press [Channel] > [Setup] > [Input] and select Input A.

The above routine can be simplified by defining the A/B small signal gain reading to be 0.00 dBr.

Return the source to -30 dBm. Now set the A/B display of gain to 0 dB by pressing [Channel] > [Rel 1].

Increase the power of the signal source until the display reads -1.00 dBr. The amplifier is now at its 1 dB compression point. Input and output powers at 1 dB compression can be viewed as before.

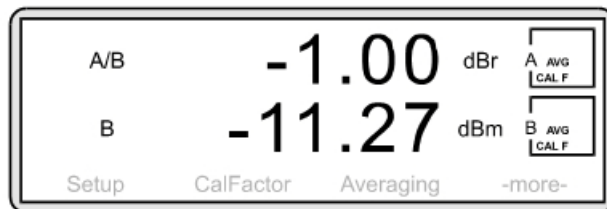

Figure 7-25.

7-7 Example 7: Measuring Pulse Signals With a Duty Cycle

In this example, we will be measuring the power output of a repetitive 500 ms pulse with a 10 ms pulse period.

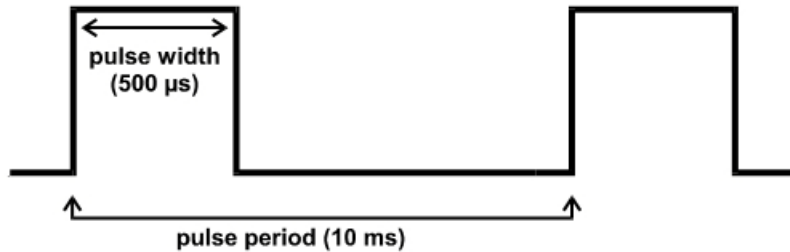

Figure 7-26.

In normal measurement mode the ML2430A power meter measures and displays average power. When the signal to be measured is a repetitive pulse, an average power reading will display average power over time and not the pulse power. By entering the duty cycle of the pulse, the meter can mathematically correct to display the pulse power. This technique assumes rectangular pulses with flat pulse tops.

Duty Cycle = Pulse Width / Pulse Period x 100 %

In the above example:

Duty Cycle = 0.5 ms / 10 ms x 100 % = 5 %

Press [Sensor] > [-more-] > [Duty cycle].

The following screen is displayed:

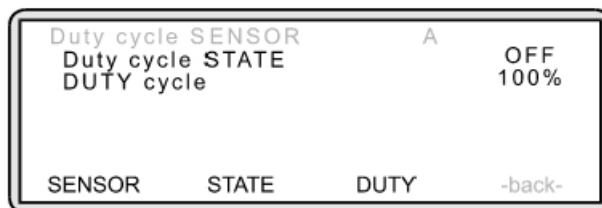

Figure 7-27.

Press [STATE] and toggle the setting by pressing the soft key until the display reads ON. Press [DUTY] and using the keypad, input a duty cycle of 5 %. Press [Enter]. To return to the Measurement screen press any hard key.

When measuring duty cycles with long pulse repetition frequencies, it may be necessary to apply the Modulated Average mode (see Example 2, Measuring Modulated Carrier). Press [Sensor] > [Setup] > [MODE].

Toggle this setting until Mod Average is displayed.

The following screen is displayed:

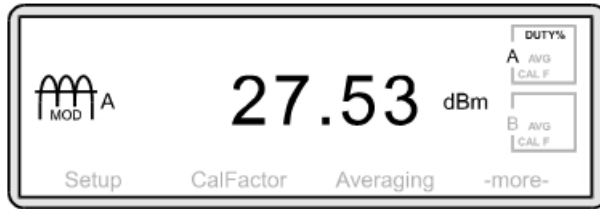

Figure 7-28.

Note

Note that box A in the top right hand corner of the screen now indicates that a Duty Cycle percentage has been applied to the Sensor.

7-8 Example 8: Profiling Pulse Signals

The ML2430A Series Power Meter can be used to view signals graphically as well as digitally. In this example, we will measure a pulse with a duration of 500 ms and a pulse period of 10 ms.

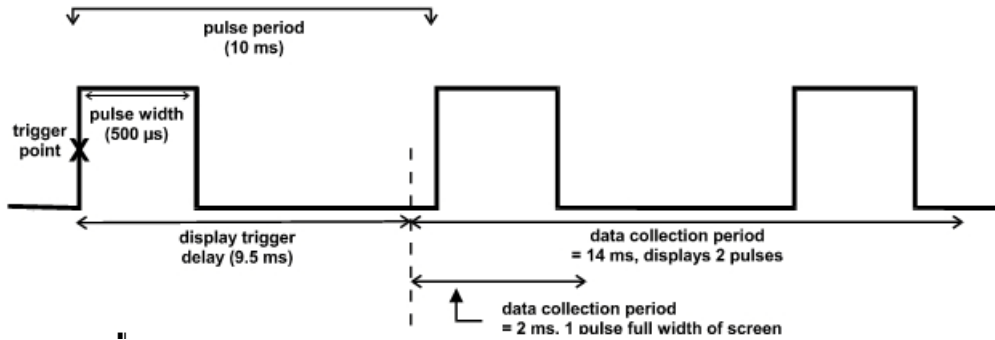

Figure 7-29.

Display trigger delay is a time delay from the trigger point to the time when the power meter starts to collect data. It can be used to view the complete rising edge of a pulse which would otherwise be on the extreme left of the instrument display.

Data collection period is the length of time for which data is captured. It also defines the time axis settings.

1. Changing from Readout to Profile mode

Press [System] > [Setup].

The following screen is displayed:

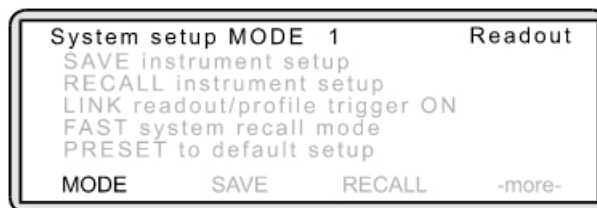

Figure 7-30.

Press [MODE] and toggle this setting until "Profile" is displayed. Press any hard key to display the Measurement screen.

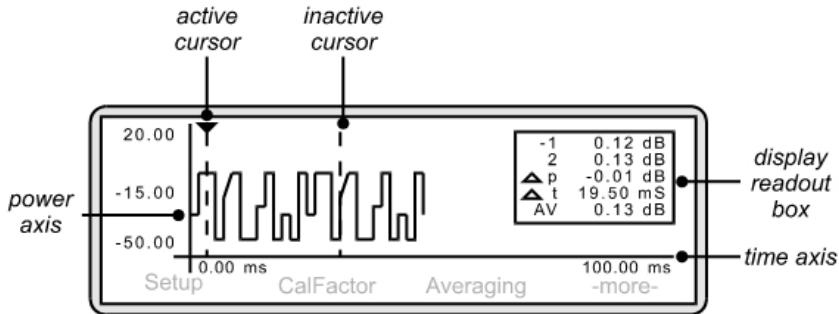

Figure 7-31.

2. Set up the triggering attributes.

Press [Trigger] > [Setup].

The following screen is displayed:



Figure 7-32.

Press [SOURCE] and toggle this setting until the trigger source you require is displayed:

- Int A Take trigger from sensor A
- Int B Take trigger from sensor B (ML2438A only)
- EXTTTL Take trigger from an external source
- MANUAL User triggers measurement from front panel soft key
- CONTINUOUS Automatic continuous trigger on completion of measurement cycle

For this example, toggle this setting until "Int A" is displayed.

To set the trigger for a falling edge, press [-more-] > [TYPE] and toggle this setting until "Fall (Int A)" is displayed. Press [LEVEL] if you wish to change from the default trigger level of -15 dB.

To display the Measurement screen, press any hard key.

The pulse is displayed on the screen and the display readout box on the right-hand side shows:

Table 7-3. Display Meanings

Item	Meaning
1	the power measurement at cursor 1
2	the power measurement at cursor 2
Δp	the power difference between cursors 1 and 2
Δt	the time difference between cursors 1 and 2
AV	the average power between cursors 1 and 2

3. Changing the axis scaling

In order to display the waveform clearly, it may be necessary to amend the X and Y axis settings. To change the time axis, press [System] > [Profile] > [Period].

The entered value of Data Collection Period determines the time axis scaling. Using the keypad, input a period value that will result in the display of the required number of pulses. Press either [ms.Enter] or [us.Enter]. In this example, a period of 10 ms will result in the display of one pulse cycle. To change the power axis, press [System] > [Control] > [-more-] > [SCALE].

Press [TOP] and/or [BOTTOM] to set the dB values as required. Press [Enter] to accept the values. Alternatively, rather than entering top and bottom values, you can select [AUTO SCALE].

4. Introducing a delay to the trigger point display.

The Measurement screen currently shows the trigger point of the pulse as occurring on the extreme left-hand side of the graph. It may be useful to show a leading edge to the pulse thus displaying activity prior to the trigger point.

Press [System] > [Profile] > [Delay]

and using the keypad, input a delay of 9.5 ms. Press [Enter] to accept the value. The Measurement screen now shows activity prior to the trigger point.

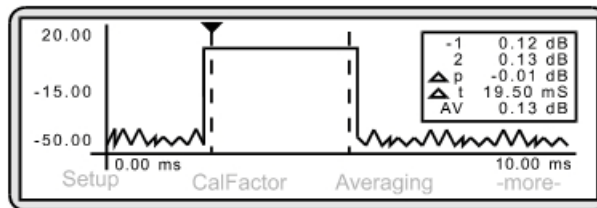

Figure 7-33.

Using the cursors

Cursors are used to define the points at which or between which power is measured. To take a measurement at a single point, position one cursor. To take a measurement between two points, use both. They are depicted as vertical dashed lines. The active cursor is depicted in two ways:

- by a triangular end cap on the end of the dotted line.
- by a hyphen against the cursor number in the display readout box (see Components of the Profiling Screen).

By positioning the cursors, the display readout box will show the average power measured between the two cursors.

Position the cursors approximately 10 % inside the start and finish of the pulse. This will help to stabilize the reading.

When Profile mode is first used, both cursors sit at the extreme right hand side of the display. To move a cursor, press [System] > [Control].

To move the active cursor, press [<<] or [>>]. To activate the other cursor, press [SWAP].

If you had multiple pulses displayed on the screen and wished to compare identical timed power readings, the cursors can be linked and then moved as a pair along the waveform. To link the cursors, press [System] > [Control] > [-more-] > [-more-] > [LINK CURSR].

If the cursors are now moved using [<<] or [>>], they move as a pair.

5. Displaying the Readout box

This box can be toggled on and off by pressing [System] > [Control] > [-more-] > [READOUT].

6. Displaying the average power in readout mode

The average power between a set of cursors is shown at the bottom of the Display Readout box. However, to display the average power in readout mode, press [System] > [Setup] > [-more-].

Press [LINK] and toggle this setting until "ON" is displayed. To return to readout mode, press [-back-] > [MODE]. Toggle this setting until "Readout" is shown. To display the resulting screen, press any hard key.

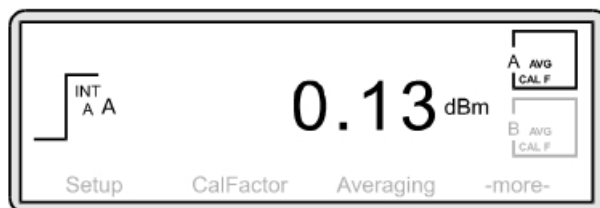

Figure 7-34.

7-9 Example 9: Displaying GSM-TDMA Bursts

The principle for viewing and measuring GSM-TDMA bursts is similar to that for profiling pulse signals. In this example, we will be measuring three GSM-TDMA bursts in an eight-slot frame.

1. Changing from Readout to Profile mode

Press [System] > [Setup].

The following screen is displayed:

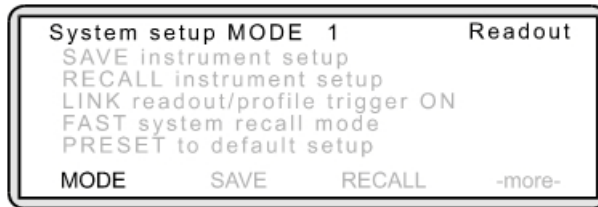

Figure 7-35.

Press [MODE] and toggle this setting until "Profile" is displayed.

2. Set up the triggering attributes

Press [Trigger] > [Setup]

The following screen is displayed:



Figure 7-36.

Press [SOURCE] and toggle this setting until the trigger source you require displays.

Int A	Take trigger from sensor A
Int B	Take trigger from sensor B (ML2438A only)
EXTTTL	Take trigger from an external source
MANUAL	User triggers measurement from front panel soft key
CONTINUOUS	Automatic continuous trigger on completion of measurement cycle

In this example, the power meter is triggered from a TTL pulse which must be connected to rear panel connector marked INPUT 1 DIGITAL. This pulse is generated by the base station, or signal source, at the start of each 8-burst frame.

To set the trigger for a TTL pulse, press [Trigger] > [Setup] > [SOURCE] and toggle this setting until "EXTTTL" is displayed. To display the Measurement screen, press any hard key.

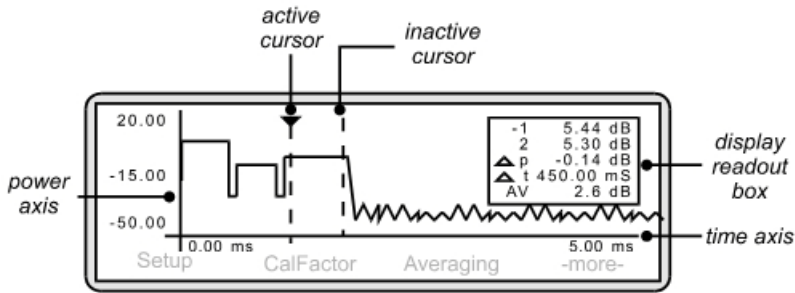

Figure 7-37.

The frame is displayed on the screen and the display readout box on the right-hand side shows:

Table 7-4. Display Meanings

Item	Meaning
1	the power measurement at cursor 1
2	the power measurement at cursor 2
Δp	the power difference between cursors 1 and 2
Δt	the time difference between cursors 1 and 2
AV	the average power between cursors 1 and 2

3. Changing the axis scaling

In order to display the waveform clearly, it may be necessary to amend the X and Y axis settings. To change the time axis, press [System] > [Profile] > [Period].

The entered value of Data Collection Period determines the time axis scaling. Using the keypad, input a period value that will result in the display of the required number of time slots. Press either [ms.Enter] or [us.Enter]. In this example, a period of 5 ms will result in the display of one frame (equals eight time slots).

To change the power axis, press [System] > [Control] > [-more-] > [SCALE].

Press [TOP] and/or [BOTTOM] to set the dB values as required. Press [Enter] to accept the values.

Alternatively, rather than entering top and bottom values, you can select [AUTO SCALE].

4. Introducing a delay to the trigger point display

The Measurement screen currently shows the trigger point of the pulse as occurring on the extreme left-hand side of the graph. It may be useful to show a leading edge to the pulse thus displaying activity prior to the trigger point.

Press [System] > [Profile] > [Delay] and using the keypad, input a delay of 4.5 ms. Press [Enter] to accept the value.

The Measurement screen now shows activity prior to the trigger point.

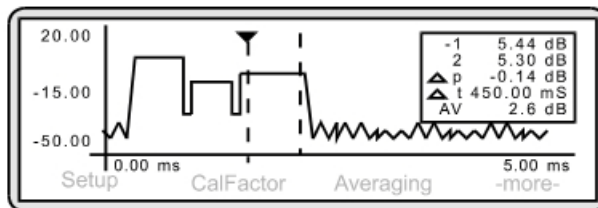

Figure 7-38.

5. Using the cursors

Cursors are used to define the points at which or between which power is measured. To take a measurement at a single point, position one cursor. To take a measurement between two points, use both cursors. They are depicted as vertical dashed lines. The active cursor is depicted in two ways:

- by a triangular end cap on the end of the dotted line.
- by a hyphen against the cursor number in the display readout box (see Components of the Profiling Screen).

By positioning the cursors, the display readout box will show the average power measured between the two cursors.

Position the cursors approximately 10 % inside the start and finish of the pulse. This will help to stabilize the reading.

When Profile mode is first used, both cursors sit at the extreme right hand side of the display. To move a cursor, press [System] > [Control].

To move the active cursor, press [<<] or [>>]. To activate the other cursor, press [SWAP].

If you wish to compare the different burst power readings, the cursors can be linked and then moved as a pair along the waveform. To link the cursors, press [System] > [Control] > [-more-] > [-more-] > [LINK CURSR].

If the cursors are now moved using [<<] or [>>], they move as a pair.

6. Displaying the Readout box

This box can be toggled on and off by pressing [System] > [Control] > [-more-] > [READOUT].

7. Displaying the average power in readout mode

The average power between a set of cursors is shown at the bottom of the Display Readout box. However, to display the average power in readout mode, press [System] > [Setup] > [-more-].

Press [LINK] and toggle this setting until "ON" is displayed.

To return to readout mode, press [-back-] > [MODE]. Toggle this setting until "Readout" is shown. To display the resulting screen, press any hard key.

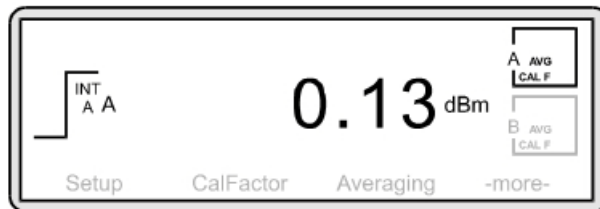

Figure 7-39.

7-10 Example 10: Power Versus Time Data Logging

To take power measurements over a user-defined period of time, press [System] > [Setup]
The following screen is displayed:

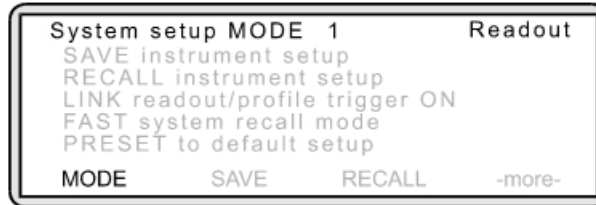

Figure 7-40.

Press [MODE] and toggle this setting until "Power v Time" is displayed. Press any hard key to display the Measurement screen.

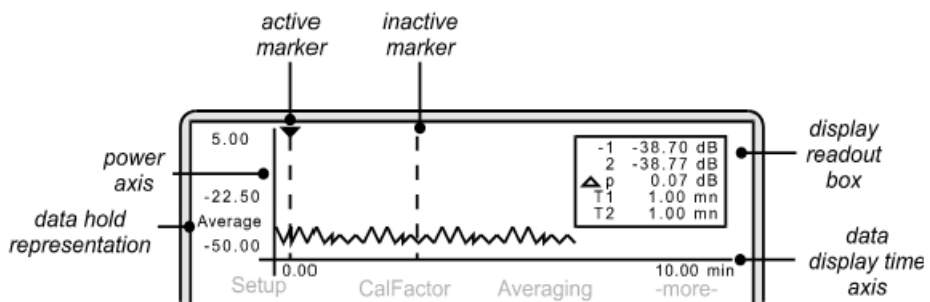

Figure 7-41. Power versus Time Measurement Screen

1. Changing the axis scaling

The data display time axis shows the length of time over which you wish to take measurements. Press [System] > [PwrVsTime] > [TIME].

Using the keypad, enter the required time. Press either [hr.Enter] or [min.Entr].

To change the power axis, press [System] > [Control] > [-more-] > [SCALE].

Press [TOP] and/or [BOTTOM] to set the dB values as required. Press [Enter] to accept the values.

Alternatively, rather than entering top and bottom values, you can select [AUTO SCALE].

2. Selecting the data hold representation

The data hold representation allows you to specify how you would like these measurements displayed on the screen. Press [System] > [PwrVsTime].

The way the power meter measures power versus time is to divide the data display time period into 200 blocks of time. For example, with a data display time period of 200 minutes, the duration of each block of time would be 1 minute. If the display time were 100 minutes, each block of time would be of 30 seconds duration.

Press [DATA HOLD] and toggle the setting by repeatedly pressing the soft key until the representation type you require is displayed.

Normal: This is the default setting and returns the last measurement taken within each block of time.

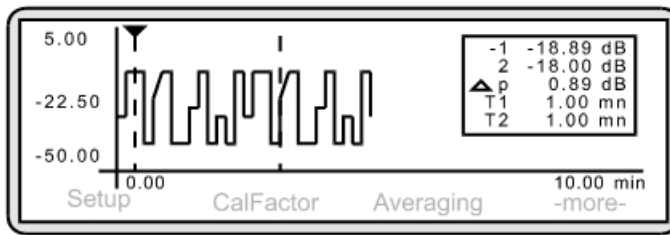

Figure 7-42.

Average: This looks at all the measurements within the block of time and returns the average power.

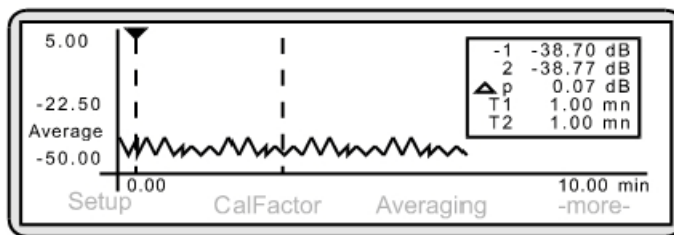

Figure 7-43.

Min: This looks at all the measurements within the block of time and returns the minimum power.

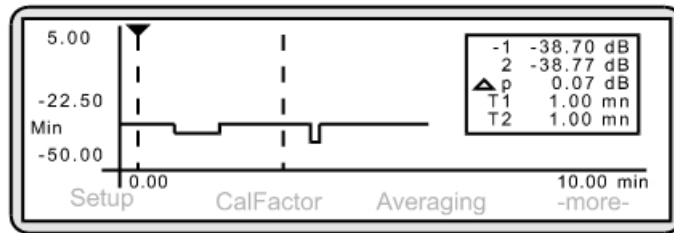

Figure 7-44.

Max: This looks at all the measurements within the block of time and returns the maximum power. The Measurement screen is similar to that achieved with Min.

Min/Max: This looks at all the measurements within the block of time and returns both the minimum and the maximum power. Both readings are connected on the graph by a line which results in a similar display to that shown below.



Figure 7-45.

Press any hard key to return to the Measurement screen. The display readout box on the right-hand side shows a combination of:

Table 7-5. Display Meanings

Item	Meaning
1	the power measurement at cursor 1
2	the power measurement at cursor 2
Δp	the power difference between cursors 1 and 2
Δt	the time difference between cursors 1 and 2
T1	the time at cursor 1
T2	the time at cursor 2

3. Using the cursors

Cursors are used to define the points at which or between which power is measured. To take a measurement at a single point, use one cursor. To take a measurement between two points, use linked cursors (see below). They are depicted as vertical dashed lines. The active cursor is depicted in two ways:

- by a triangular end cap on the end of the dotted line.
- by a hyphen against the cursor number in the display readout box (see Components of the Profiling Screen).

By positioning the cursors, the display readout box will show the power or time measured at each cursor and also the power or time difference between the cursors, depending upon the data hold mode selected.

To move a cursor, press [System] > [Control].

To move the active cursor, press [<<] or [>>]. To activate the other cursor, press [SWAP].

If you wished to compare identical time duration power readings, the cursors can be linked and then moved as a pair along the waveform. To link the cursors, press [System] > [Control] > [-more-] > [-more-] > [LINK CURSR].

If the cursors are now moved using [<<] or [>>], they move as a pair.

4. Displaying the Readout box

This box can be toggled on and off by pressing [System] > [Control] > [-more-] > [READOUT].

7-11 Example 11: Frequency Measurements Using a Separate Source

In the previous examples, we have been working with variable power on a fixed frequency. In this example, we will be measuring power against swept frequency.

Between the frequency start point and the frequency stop point (i.e. 1 GHz to 2 GHz), you can take a power measurements at each point and plot the power between them. This is a frequency response measurement.

1. Connecting the meter to the device under test

Prior to starting this type of measurement, it is necessary to connect the power meter to the signal source using BNC cables.

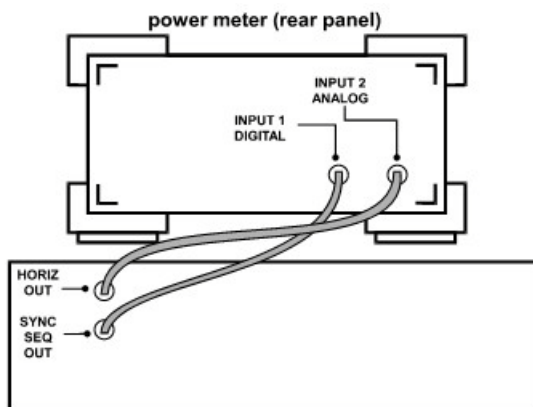

Figure 7-46. Signal Source (Rear Panel) Anritsu 68000 or 69000 Series

2. Selecting Source Sweep mode and defining frequencies.

Press [System] > [Setup].

The following screen is displayed:

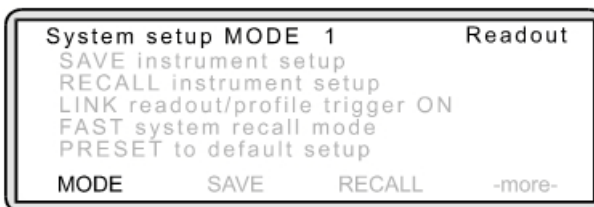

Figure 7-47.

Press [MODE] and toggle this setting until "Source Sweep" is displayed.

Press [System] > [Source sweep] > [-more-].

Example 11: Frequency Measurements Using a Separate Source Measurement Examples

Press [START] and using the keypad, input the frequency at which the sweep starts.
Press [Enter] to accept the value.

Press [STOP] and using the keypad, input the frequency at which the sweep stops.
Press [Enter] to accept the value.

The following screen is displayed:

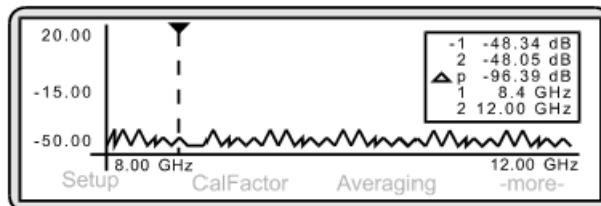

Figure 7-48.

Note that the frequency axis reflects the Start and Stop settings. Each time you measure at different frequencies, it is necessary to re-input the [START] and [STOP] values.

To achieve the maximum dynamic range, apply the highest levelled output power for the source as possible i.e. +20 dBm.

3. Changing the power axis

To change the power axis, press [System] > [Control] > [-more-] > [SCALE].

Press [TOP] and/or [BOTTOM] to set the dB values as required. Press [Enter] to accept the values.

In Source Sweep mode, you are unable to measure levels of less than -50 dBm.

In Source Sweep mode, the calibration factor is handled in a different manner since it is defined by the current frequency of the source. Press [Sensor] > [Cal Factor].

Press [SOURCE] and toggle the setting by repeatedly pressing the soft key until the V/GHz is displayed.

To display the Measurement screen, press any hard key.

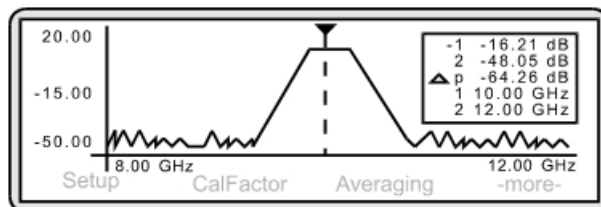

Figure 7-49.

The response of the device under test is displayed on the screen and the display readout box on the right-hand side shows:

Table 7-6. Display Meanings

Item	Meaning
1	the power measurement at cursor 1
2	the power measurement at cursor 2
Δp	the power difference between cursors 1 and 2
x1	the frequency at cursor 1
x2	the frequency at cursor 2

4. Using the cursors

Two cursors are used to define the points at which or between which power is measured. They are depicted as vertical dashed lines. The active cursor is depicted in two ways:

- by a triangular end cap on the end of the dotted line.
- by a hyphen against the cursor number in the display readout box (see Components of the Profiling Screen).

By positioning the cursors, the display readout box will show the average power measured between the two cursors.

When Profile mode is first used, both cursors sit at the extreme right hand side of the display. To move a cursor, press [System] > [Control].

To move the active cursor, press [<<] or [>>]. To activate the other cursor, press [SWAP].

To measure the power difference between the cursors, link them first.

Press [System] > [Control] > [-more-] > [-more-] > [LINK CURSR].

If the cursors are now moved using [<<] or [>>], they move as a pair.

Chapter 8 — GPIB Operation

The majority of the GPIB commands have equivalents in the front panel menu settings. Note that GPIB operation is not available when the power meter is running from the internal battery (option 2000-996-R). The ML243xA Power Meter supports the IEEE 488.2–1992 GPIB standard in ML24XXA (native) mode (HP emulation commands are not GPIB 488.2 compliant). For further information about GPIB programming, refer to the IEEE 488.1/2 Standards documents.

8-1 Data I/O Formats

All ML24XXA (native) GPIB 488.2 commands that use parameters must have a space between the command header and the first parameter, and all subsequent parameters must be separated by a comma (.). Multiple commands may be sent on the same line, but must be separated by a semicolon (;).

The format for ML243xA (native) GPIB commands is:

```
<command header><space><parameter 1>,<parameter n>,...
```

HP and ML4803 emulation commands on the other hand, do not have to have a space between the command header and the parameter, or commas between the parameters.

The format for HP emulation commands is:

```
<command header><parameter 1><parameter n>...
```

The end of the command text must be terminated with either a line feed character (0Ah, decimal 10) or a GPIB End of Transmission State (EOI), or both.

Data input and output formats and templates referred to throughout this chapter are delimited with the less-than and greater-than characters (< >). Optional parameters and suffix characters are delimited with brackets ([]). These characters are not part of the data and are only used in this text to distinguish the data elements they represent.

All the commands which allow a level to be set as a value argument are floating point values which can use the E-0x convention or a suffix multiplier. The GPIB standard [units] convention (SEC for seconds, MS for milliseconds, etc.) IEEE codes and formats have been implemented for the suffix units and multipliers. The suffix unit is always allowed but is not required and is shown in brackets where appropriate.

The table below lists the numeric data suffix mnemonics for the ML243xA Power Meter. These mnemonics are used when entering numeric data with GPIB commands (use of these codes is optional).

Commands which are not floating point, but integer, are:

Table 8-1. Numeric Data Suffix Mnemonics

Suffix Multipliers		Suffix Units	
Definition	Mnemonic	Definition	Mnemonic
1E18	EX	Decibels	DB
1E15	PE	dB ref to 1 mW	DBM
1E12	T	dB ref to 1 mV	DBUV
1E9	G	Megahertz	MHZ
1E6	MA	Percent	PCT
1E3	K	Seconds	SEC
1E-3	M	Seconds	S
1E-6	U	Volts	V
1E-9	N	Watts	W
1E-12	P	Hertz	HZ
1E-15	F		
1E-18	A		

All of the Status enable type commands (*SRE for example)

Stored numbers (i.e., 0, 1, 2, 3, 4, 5)

Offset table numbers (i.e., 1, 2, 3, 4, 5, 6...)

GPIB addresses (1 to 30)

User Averaging number in the AVG command (1 to 512)

Display contrast number (1 to 12).

The ML243xA data formats are summarized below:

<NR1>

This notation represents ASCII integer values. A comma (,) is used to separate multiple values sent in a single command input or output string.

Examples of values that can be represented by <NR1> notation:

1
0
-29,179

<NR2>

This notation represents ASCII floating point values in decimal point format. A comma (,) is used to separate multiple values sent in a single command's input or output string.

Examples of values that can be represented by <NR2> notation:

1.0
-0.00015
12.743, -180.07

<NR3>

This notation represents ASCII floating point values in exponential format (scientific notation). A comma (,) is used to separate multiple values sent in a single command's input or output string.

Examples of values that can be represented by <NR3> notation:

1.0E9
7.056E3
9.0E2,3.42E2

<NRf>

This notation is used to signify that data can be in either <NR1>, <NR2>, or <NR3> format as described above. Examples of values that can be represented by <NRf> notation:

1.0E9
10.005
83,4.5E2,234.9901

<String>

This notation represents a string of 7-bit ASCII characters (including non printable characters) that is delimited (surrounded) with either single quotes (') or double quotes (""). The string can include text formatting characters such as linefeed, space, or carriage return. Note that if a double quote character must be sent as part of the string, then it must be followed by an additional double quote. Alternatively, the string can be sent using single quotes as shown in the "cal_file" example below. Examples of data represented by <String> notation are:

"1/15/98"
"Save ""cal_file"" now."
'Save "cal_file" now.'

<Arbitrary ASCII>

This notation represents undelimited 7-bit ASCII text. The end of the text must be terminated with the line feed character (0Ah, decimal 10) or a GPIB End of Transmission State (EOI), or both. This requirement makes it necessary for <Arbitrary ASCII> text to be transmitted only at the end of a program or response message, that is, at the end of a multiple input or output statement.

Example of data represented by <Arbitrary ASCII> notation:

Anritsu,2410A,123456,1.0<0A^EOI> The example shows a sample response from the *IDN?, 488.2 common query. In the example, the instrument identifies itself as an Anritsu 2410A, with serial number 123456, and software version 1.0 installed. Note that decimal 10 (0Ah character) must be sent with the EOI to signal end of transmission.

<Arbitrary Block>

This notation represents data transmitted as 8-bit data bytes (00-FF hex, 0-255 decimal, notation is <DAB>). Useful for transmitting large blocks of formatted ASCII or binary data or unformatted binary data. The data stream is immediately preceded by a variable length ASCII header that is encoded with the number of data bytes to be sent. The header always starts with the (#) character.

8-2 Query Commands

Many ML24XXA (native) GPIB commands have an equivalent query command that will return a current value or setting. Query commands and their returned strings are provided with each command where applicable.

A complete listing of valid query commands and returned strings is provided in Appendix C.

8-3 GPIB PC Card Setup

The following GPIB driver configuration set up is recommended for reliable GPIB communication with the ML243xA Power Meter. The set up is expressed in the terms used by the National Instruments GPIB ISA and PCI cards and drivers for Windows and DOS.

GPIB Device Template

The ML243xA default primary address is 13. Separate device templates for the primary address of each device can usually be set up separately. The settings for the device template for the ML243xA are shown in the table below.

Table 8-2. Template Settings

Item	Setting
Set EOI with EOS on write	YES
Type of compare on EOS	8 bit
EOS byte	0x0A (10 decimal)
Send EOI at end of write	YES
Readdressing	YES
Secondary address	NONE

GPIB Card Settings

The recommended GPIB card settings for use with the ML243xA are shown in the table below.

Table 8-3.

item	Settings
Terminate read on EOS	No
Set EOI with EOS on writes	YES
Type of compare on EOS	8 bit
EOS byte	0x0A (10 decimal)
Send EOI at end of write	YES
System controller	YES
Assert REN when SC	YES
Enable Auto Serial polling	NO
NI card. Cable length for HS488	OFF

8-4 Using 488.1 GPIB

IEEE 488.1 level commands are in the form of data byte codes with the attention (ATN) line set. A separate function is normally provided to drive these commands from a GPIB program. A typical GPIB driver library call for 488.1 and 488.2 is given for each of the following commands. Refer to the IEEE 488.1 and IEEE488.2 device driver manuals for full definitions of the responses, and to find the actual command format for your GPIB driver library.

Device Clear (DCL) and Selected Device Clear (SDC)

These commands clear the GPIB device interface and have the following effects:

- All buffered messages waiting to be processed are cleared.
- All buffered data waiting to be read from the device is cleared.
- Stop any pending actions.

For example, if a request for data has been sent, and the system is waiting for the reading to be triggered, the system would wait until the reading has been provided before any further GPIB commands can be processed. The device clear will clear the data request so further GPIB commands after the device clear has completed can be actioned.

Typical device library calls are 488.1 'ibclr' and 488.2 'DevClear'.

Device trigger (GET)

This command triggers a GPIB device. An action predefined by the setup of the device being triggered will take place. On the ML243xA, the device trigger provides a trigger of the type defined by the GTn commands previously sent and a reading put into the output buffer for each display channel that is not OFF. In Profile mode, the profile display for the selected channel only is output. Typical device library calls are 488.1 'ibtrg' and 488.2 'Trigger'.

Goto local (GTL)

This command forces the device out of remote mode and into local operation mode. The local operation keys and menus are now available.

Typical device library calls are 488.1 'ibloc' and 488.2 'EnableLocal'.

Interface clear (IFC)

This is part of the GPIB initialization and forces the board to the controller in charge. Typical device library calls are 488.1 'ibsic' and 488.2 'SendIFC'.

Local lockout (LLO)

Sends the local lockout to all devices. The local lockout disables the 'LOCAL' key on all the devices.

Typical device library calls are 488.1 'ibconfig' plus correct option and 488.2 'SendLLO'.

Serial poll

This command will clear any SRQs and read the status byte of the device.

Typical device library calls are 488.1 'ibrsp' and 488.2 'ReadStatusByte'.

8-5 Using 488.2 GPIB

The IEEE 488.1 GPIB standard was updated in 1987 to 488.2 to better enforce standardization of GPIB communication. This section explains the fundamentals of 488.2 GPIB operation and how it is implemented in the ML243xA Power Meter. Refer to the full IEEE 488.2 standard for more detailed information.

8-6 488.2 Command Format

All commands should follow the basic format:

<MNEMONIC><white space><comma separated message parameters><terminator>

<white space> = Normally a space character, but can be any of the white space characters listed in the 488.2 manual.

<terminator> = A line feed character (for example, \n in 'C' or VBLF in Visual Basic). An EOI (End Of transmission Interrupt) can be used as the last character instead of the line feed.

Example: AVG A,MOV,64

A number of commands can be put into one program message by separating the commands with semicolons. Example:

CHCFG 1,A;CHCFG 2,B-A;CHUNIT 1,W;CHUNIT 2,DBM;OPMD DIGIT

Status Byte

The 488.2 standard added two extra predefined bits to the status byte, these bits are the Event Status Bit (ESB) and the Message Available bit (MAV).

Event Status Bit (ESB)

In 488.2 there is an event status register (ESR) that allows the state of the GPIB interface to be monitored. All the bits in this register are defined. These bits are:

7	6	5	4	3	2	1	0
PON	URQ	CMD	EXE	DDE	QYE	RQC	OPC

Table 8-4. Event Status Register (ESR)

Bit	Description
PON	Power On bit. This bit is set on power up of the device only.
URQ	Not used in the ML243xA
CMD	Command error. Received an illegal command.
EXE	Execution error. Could not execute a command. For example, a parameter is out of the allowable range, or requesting graph data while in readout mode.
DDE	Device Dependent Error. The specific error can be found by using the ERRLST command.
QYE	Query Error.
RQC	Request Control. GPIB controllers only.

Table 8-4. Event Status Register (ESR)

Bit	Description
OPC	Operation Complete. When a program message that includes the *OPC command has been completed, and the GPIB interface is idle, with any responses read out of the output buffer this bit is set. For example, if the last command in a configuration sequence is *OPC, the OPC bit in the event status register will be set when that configuration list has been completed.

If an event causes a bit in the ESR to be set and the corresponding bit in the Event Status Enable byte (ESE) is set, the ESB bit in the status byte will be set. This can cause an SRQ (see Section 6-8) if the ESB bit in the Status Register Enable byte (SRE) is set. For example, to get an SRQ on an unrecognized command do the following:

1. Set the CMD bit in the event status enable byte, and set the ESB bit in the status register enable byte. Send:
`*ESE 32 ; *SRE 32`
2. Now if an unrecognized command is sent to the ML243xA, an SRQ will be given. Send:
`asdf`
3. An SRQ will be indicated.
4. To clear the SRQ do a serial poll, this should return the decimal value 96, bit 6 for the SRQ and bit 5 for the ESB. The SRQ will be cleared.
5. To read the Event Status Register (ESR), send:
`*ESR?`
6. This will put 32 (or 160 if PON is set) in the output buffer to be read.

Message Available Bit (MAV)

This bit is set if there is any data in the output buffer waiting to be read, and can be used to ensure that only the latest reading is used. Upon receiving a request for data, the next reading taken is put in the output buffer. The data in the output buffer should always be read when data is available to ensure that old data is never left behind. The advantage of this method is that if the MAV bit is not set, the controller can not read old data, therefore data can only be read after it has been requested. Example:

1. In Readout display with the output buffer empty and the MAV bit not set, configure the ML243xA to give an SRQ on data becoming available by setting bit 4 in the Status Register Enable byte (SRE):
`*SRE 16`
2. Request data from display channel 1 by sending:
`O 1`
3. The SRQ will be set with the new reading which will now be in the output buffer ready to be read. The data should now be read so that the MAV bit will be cleared. If the data is not read, or the output buffer not cleared, and another request for data is made this data will be buffered after the previous data.

Getting a Reading

The 488.2 standard requires that the data can only be read from the device after it has been requested. Any data requested from the device is made available to be read, and is stored in an output buffer.

As long as there is data in the output buffer to be read, the Message Available (MAV) bit in the status byte is set. This bit allows data to be requested and, as soon as the data is available, the MAV bit is set, from which a service request can be produced (SRQ).

The ML243X allows this output buffer to be turned off using the BUFF OFF command. In this mode of operation, if a number of data requests are made without reading the data after each request, only the last data requested is available. Note that this does not include the serial poll request which is handled independently.

Service Request Status (SRQ)

The System Service Request Status byte available over GPIB by a serial poll is defined as follows:

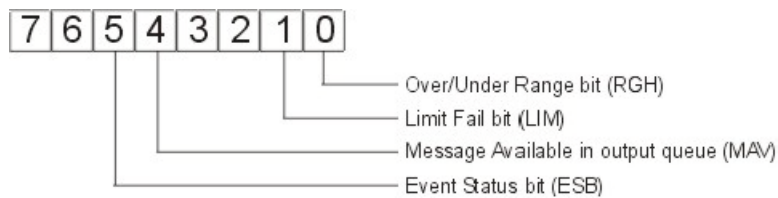

Figure 8-1. Service Request Status

RGH

If a sensor goes over or under the operating range, this bit is set. This bit can be used to set an SRQ by setting the same bit in the SRE register using the *SRE command. For more detail, see the STATUS command. This bit can only be cleared by sending a *CLS command.

LIM

If a channel pass/fail limit fails, this bit will be set. This bit can be used to set an SRQ by setting the same bit in the SRE register using the *SRE command. For more detail, see the STATUS command. This bit can only be cleared by sending a *CLS command.

MAV

If data is available in the output queue, this bit is set. This bit can be used to set an SRQ by setting the same bit in the SRE register using the *SRE command. This bit is only cleared when there is no data waiting to be transmitted.

ESB

If any of the event register bits are set and the corresponding event status enable bits are set the ESB bit in the status byte will be set. This bit can be used to set an SRQ by setting the same bit in the SRE register using the *SRE command. The ESB bit is cleared when the ESR is read by using the *ESR? Command.

8-7 Functional Groups

Throughout the ML24XXA (native) mode section of this chapter, the distinctive, white on black text, in the upper corner of each command description area, indicates the Functional Group to which the command belongs (Figure 6-1). All ML24XXA (native) commands are presented by Functional Group in Appendix C, GPIB Quick Reference.

The Functional Groups are:

BNC

Commands in this group are used to configure the rear panel BNC inputs and outputs.

Calibration

The CALIBRATION group commands are used for the 0.0 dBm reference calibration and zeroing of the power sensors.

Channel

The CHANNEL command group controls the configuration of the two channels. When both channels are activated, Channel 1 appears at the top of the display and Channel 2 at the bottom. If one channel is turned off, the remaining channel appears in the centre of the screen.

Data Output

Commands in this function group are used to place data on the GPIB to be read by the controller.

Display

These commands control characteristics of the display, including the peakmeter reading display and contrast adjustments.

GPIB 488.2

This group contains the GPIB 488.2 mandatory commands. Refer to the IEEE 488.2-1987 Standards documents for further information.

GPIB Setup

The commands in this group control the GPIB Address, GPIB command set emulation mode (ML24XXA, ML4803A or HP Emulation), and other parameters.

GPIB Trigger

Commands in this group are used to configure GPIB triggering and setup the GPIB Group Execute Trigger (GET) and TR commands (TR0, TR1, TR2, TR3). Note that these commands are exclusive to GPIB, and do not have equivalent front panel operations.

Profile Setup

The PROFILE SETUP function group commands change how the profile is displayed on the screen. Note that the Display Trigger configuration commands (DTRGD and GRPRD) in this group do not change how the system triggers, only where the graph is drawn after a trigger has occurred. Refer to the TRIGGER group functions to configure the measurement triggering.

Sensor

The SENSOR group commands select the data acquisition controls for the selected sensor.

System

The SYSTEM group commands control the overall functionality of the ML243xA Power Meter, including the system operation mode, cursor control, display configuration, sound, printing, battery control and status, rear panel configuration, graphics, system security, and system identity.

Trigger

The TRIGGER group functions are used to program the triggering of measurement data. TRIGGER group commands are available in PROFILE operation mode, and in READOUT mode if the SENSOR > SETUP > MODE submenu is set to CUSTOM.

In CUSTOM, the channels are triggered simultaneously if the trigger conditions are set to 1 and 2. This guarantees the trigger conditions are the same, and therefore the readings are valid if taken at the same time.

Changes to the trigger configurations can be made using these GPIB commands regardless of the power meter operating mode, but will not come into play until the unit is configured to use triggers.

8-8 ML24xxA Native Commands

This section provides an alphabetical listing of the GPIB commands (mnemonics) used to program the Model ML243xA Power Meter in ML24XXA (native) mode. The emulation mode can be set through the front panel SYSTEM > more > more > Rear panel > GPIB > MODE menu (see Chapter 4, Operation) or through the GPIB command EMUL.

All ML24XXA (native) GPIB commands that use parameters must have a space between the command header and the first parameter, and all subsequent parameters must be separated by a comma (.). Multiple commands may be sent on the same line, but must be separated by a semicolon (;).

The format for ML24XXA (native) GPIB commands is:

<command header><space><parameter 1>,<parameter n>,...

The end of the command text must be terminated with a line feed character (0Ah, decimal 10) or a GPIB End of Transmission State (EOI), or both.

***CLS (Clear GPIB status bytes)**

Syntax: *CLS

Remarks: This command performs a status data structure clear command. The event status register and the status register are cleared except for the MAV bit.
 *CLS does not clear the output buffer.

***ESE (Event Status byte Enable)**

Syntax: *ESE <val>

val: 8-bit mask

Remarks:

Sets the Standard Event Status Enable Register bits.

Bit 7: Power ON, when there has been a transition from a power OFF state to a power ON state.

Bit 5: Command Error. This bit is set when an incorrect GPIB code is sent to the power meter.

Bit 4: Execution Error. This bit is set when incorrect data is sent to the power meter, e.g., ADDR 57 would result in an Execution Error as the allowable address value range is 1 to 30.

Bit 3: Device Dependent Error (DDE). This bit is set true whenever a measurement error occurs. Device Dependent Errors are:

ZERO fail - Zero attempted for a sensor and failed.

CAL 0 dBm fail - 0 dBm value to far out.

Display channel number goes out of displayable range -

Displayable range is -270 dBm to +220 dBm.

Illegal log calculation for a channel - When a channel input

configuration combines sensors, the combination is done in

linear units. If the result of the combination produces a

negative linear value and the displayed units are log

(i.e., dB) this would be an illegal logarithmic operation.

Printer error - A print was requested and this error was

returned.

Request for data from a channel with no sensor connected.

Bit 0: Operation Complete. This bit is set when the *OPC command completes and can be used to tell the controller the unit has completed those commands just sent. See *OPC and *OPC? for more details.

All other bits are not used. The bits above are 488.2 common bits. The ERRLLST command will return an error list giving the state of the DDE causes.

Related
commands:

*ESR?, *ESE?, ERRLLST

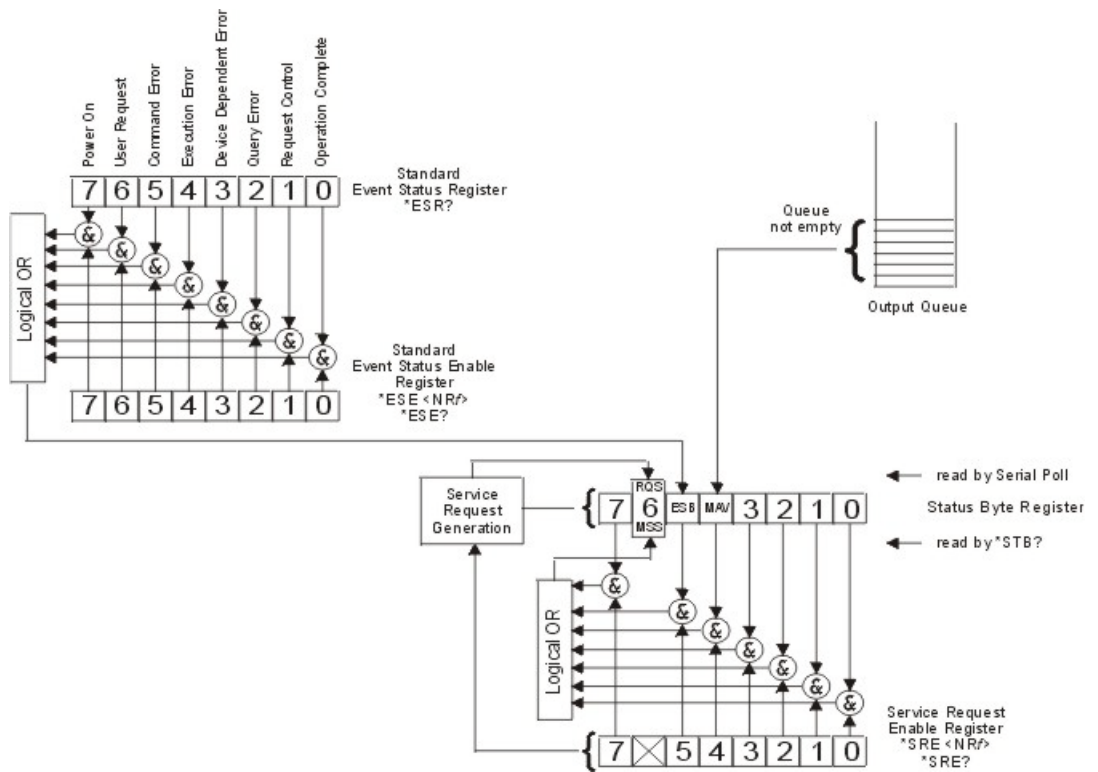

Figure 8-2. IEEE 488.2 Standard Status Structures

***ESE? (Return Event status register enable mask)**

Syntax: *ESE?

Remarks: Returned format: <unsigned character>
When converted to an 8-bit binary number, this byte yields the bit settings of the register.

***ESR? Event status register request**

Syntax: *ESR?

Remarks: Return the value of the standard event status register. Afterwards the event status register are cleared. The returned format is: <unsigned character>. When converted to a 8-bit binary number, this byte yields the bit settings of the register.

***IDN? (Request device identification)**

Syntax: *IDN?

Remarks: Returned format:
<Company name>,<model>,<serial>,<firmware version>

***OPC (Operations complete)**

Syntax: *OPC

Remarks: The ML243xA generates the OPC event in the standard event status register when all pending operations have finished. An operation is complete when all input messages before the command have been completed and any responses have been read out of the output buffer.

Example: RGH A, 1; RGH B, 3; *OPC

Will set the Operations Complete bit in the Event Status Register once the Range Hold commands have completed.

***OPC? (Operations complete Output '1')**

Syntax: *OPC?

Remarks: Places a single ASCII character '1' on the GPIB output queue when the conditions for the *OPC command are met. An operation is complete when all input messages before the command have been completed and any responses have been read out of the output buffer.

Example: RGH A, 1; RGH B, 2; *OPC?

Returns a '1' on the GPIB output when it has finished setting the range hold commands.

***RCL (Recall a stored setup)**

Syntax: *RCL <val>
 val:
 1 to 10

Remarks: The ML243xA can store up to 10 instrument configurations for convenient recall. The configuration parameters stored are: Sensor Setup, Channel Setup, and Trigger Setup. This command sets the ML243xA to a configuration previously stored in memory locations 1 through 10. Trying to recall a setup that has not been saved will set the execution bit in the event register (EXE in ESR).

Related commands: *SAV

***RST (Reset Device)**

Syntax: *RST

Remarks: Resets the ML243xA to the default configuration (see Appendix A, Section A-3). Offset tables are not cleared. The GPIB address and emulation settings are not changed, and the input queue, output queue, and status registers on the GPIB are not cleared. This command produces the same result as the front panel key sequence System > Setup > PRESET > RESET.

***SAV (Save configuration)**

Syntax: *SAV <val>
 val:
 1 to 10

Remarks: Saves the configuration of the power meter into the memory location specified. Sensor Setup, Channel Setup, and Trigger Setup are saved along with all other instrument parameters.

Related commands: *RCL

***SRE (Setup service request enable register)**

Syntax: *SRE <val>
 val:
 8-bit mask

Remarks: Sets the Service request enable register bits.

***SRE? (Return Service Request Enable register)**

Syntax: *SRE?

Remarks: Returns the Service Request Enable register.

***STB? (Return Status Byte register)**

Syntax: *STB?

Remarks: Returns the status byte value with bit 6 replaced with the MSS value. MSS is the GPIB Master Summary Status, and indicates that the device has at least one reason for requesting service. Although the MSS message is sent in bit position 6 of the device's response to the *STB? query, it is not sent in response to a serial poll and should not be considered part of the IEEE 488.1/2 status byte. MSS = the Status Byte (STB) OR'ed with the Service Request Enable register (SRE). Unlike the *ESR? Command, this command does not clear the register afterwards.

***TRG (Perform the GPIB 'Group Execute Trigger' command)**

Syntax: *TRG

Remarks: Performs a 'GET' command. The GT0, GT1 and GT2 commands set the response to the GET or *TRG commands. When the ML2430 Series is triggered using this command or the 488.1 hardware trigger, a trigger and output for each display channel that is not OFF gives a response in the output queue. If both display channels are displayed, there will be two messages in the output queue to be read out.

Related commands: GT0, GT1, GT2

***TST? (Self Test)**

Syntax: *TST?

Remarks: Performs a self test and returns 'SUCCESS' or 'FAILED.'
NOTE: This command will restart the sweep in Power vs. Time mode.

Related commands: STERR

ADDR (Change GPIB address)

Syntax: ADDR <val>

val:

1 to 30

Remarks: Once the address has been changed, the ML243xA will no longer respond to the old address. The power meter default address is 13.

Query: ADDR?

Returned String:

ADDR <val>

AVG (Sets up averaging for a sensor)

Syntax: AVG <s>, [<mode>],[<val>]

s: A or B

mode:

OFF

MOVMoving

RPTRepeat

AUTOAutomatic

val: ASCII string representing an integer, 1 to 512.

Remarks: MOVING average gives an update to the meter every sample/gate (normally 20 ms).

REPEAT averaging only returns a reading when the number of readings specified by <val> have been taken (1-512).

AUTOMATIC averaging uses a MOVING type of average. The display updates at approximately 100 ms intervals, however the data is available at the full rate. The display is slowed down to prevent jitter and allow the user to follow the update. Since AUTOMATIC averaging automatically chooses an average number with the averaging mode set internally to MOVING, the USER averaging number is not used.

However, if a value is entered in the same command as the one which changes to AUTO averaging, it will also update the USER averaging number.

Example: AVG A, AUTO, 64

This command will set the system to AUTO averaging and the USER averaging number to 64. But, the Auto Averaging measurement system does not use the USER averaging number.

Note: The AVG mnemonic can be sent to just change the <mode> of averaging (MOV, REPEAT etc.) without sending a number, but there must be a following COMMA to indicate the <val> parameter is not being sent. See the first example below.

The AVG mnemonic can also be sent to just change the User Average Number <val> (1 to 512) without changing the averaging mode, but there must be a COMMA to indicate the <mode> parameter is not being sent. See the last example below.

Query: AVG? <S>

Returned String: AVG <S>,<MODE>,<VAL>

AVGLL (Auto low level averaging)

Syntax: AVGLL <s>,<mode>

s: A or B

mode:

OFF

LOW

MEDIUM

HIGH

Remarks: Sets the low level averaging window for the sensor. At resolution settings of 0.01 and 0.001dB, digital readouts may flicker due to the high reading rate of the ML243xA. Low level averaging applies a low pass filter to post-average data readings to achieve a more stable front panel display without slowing down the response of the meter to larger changes in level. The three windows for LOW, MEDIUM and HIGH low level averaging are ± 0.01 , 0.02, and 0.05 dB.

For example: When a LOW setting of low level averaging is applied while stepping from 0 dBm to -1 dBm, the meter displays the final reading within 0.01dB with no delay. The final settling of 0.01dB will settle over a short subsequent period of time, leading to a stable high resolution readout.

With a HIGH setting of low level averaging, the settling window is increased (up to approximately 0.05 dB) and the settling time is longer.

With low level averaging OFF, the meter displays the final reading instantly with no further settling observed. Any jitter due to noise is reflected in the displayed reading, which may be inconvenient for high resolution readings.

Example: AVGLL A,HIGH

Query: AVGLL? <S>

Returned String: AVGLL <S>,<MODE>

AVGM (Manual Averaging)

Syntax: AVGM <s>

s: A or B

Remarks: Changes the averaging of the sensor to 'Moving' averaging mode from 'Auto' Averaging. The average number is set to the same value that the 'Auto' averaging mode was using internally. If the sensor is not presently in auto averaging mode, this command is ignored.

BAUTS (Battery Auto Turn OFF)

- Syntax: BAUTS <state>
state: ENABLE or DISABLE
- Remarks: Enable/disable the battery auto power shut off.
Note: Although GPIB is not available under battery operation, the state of this parameter can be changed for later use.
- Query: BAUTS?
Returned String: BAUTS <state>

BAUTT (Battery Auto shut off after x minutes)

- Syntax: BAUTT <val>
val: 10 to 240 minutes
- Remarks: Automatically turns the unit off after x minutes when operating on battery power.
Note: Although GPIB is not available under battery operation, the state of this parameter can be changed for later use.
- Query: BAUTT?
Returned String: BAUT <val>

BUFF (GPIB response buffering enabled)

- Syntax: BUFF <s>
s: ON OFF
- Remarks: If BUFF is ON: In the ML243X native mode, 488.2 GPIB operation, when a request for data is made the response is put in an output buffer ready to be read by the controller. If another data request is made and the previous data has not been read out of the output buffer; the new data is queued after the original request. In this mode of operation the GPIB response buffering enable is ON, and following the 488.2 specifications when ever a request for data is made the response should be read.

If BUFF is OFF: In this mode when ever a request for data is made, (except by serial poll) the output buffer is cleared and the only data in the output queue will be the response to the last data request made. The output buffer is cleared once a valid GPIB data request command has been recognized.
- Note: If the buffering enabled is set to OFF and '*OPC?' is used, the '*OPC?' will clear the output buffer of any previous response data so only the '1' will appear.

CAL (Cal sensor to 0 dBm reference)

Syntax: CAL <s>

s: A or B

Remarks: Performs a 0dBm calibration when the sensor is attached to the reference 0 dBm source on the ML243xA (or another 0 dBm reference source). If the calibration fails, the 'execution error' bit in the Event Status Register is set.

CFADJ (Cal Adjust)

Syntax: CFADJ <s>, <units>, <val>

s: A or B

units: %, PCT, DB, or DBM

val: .07 to 150% +31.55 to -1.76dB

Remarks: Sets a calibration factor to be used when performing a 0 dBm calibration and the calibration factor source is set to 'Manual.' This value is the only factor applied when performing a 0 dBm calibration. If the sensor calibration factor source is set to V/GHz or Frequency, the sensor internal EEPROM correction value at 50 MHz is used.

Example:

CFADJ A, %, 99

Sets the calibration factor to 99% for sensor A.

CFADJ A, DB, 0.2

Sets the calibration factor to 0.2 dB for sensor A.

Query:

CFADJ? <s>

Returned String: CFADJ <s>,<units>,<val>

CFCAL (Cal factor manual setting)

Syntax: CFCAL <s>, <units>, <val>

s: A or B

units: %, PCT, DB, or DBM

val: .07 to 150% +31.55 to -1.76 dB

Remarks: If the Cal factor source is set to manual, this is the calibration factor number used.

Example:

CFCAL A, %, 99

Sets the calibration factor to 99% for sensor A.

CFCAL A, DB, 0.2

Sets the calibration factor to .2 dB for sensor A.

Query:

CFCAL? <s>

Returned String: CFCAL <s>,<units>,<val>

CFFRQ (Cal Factor Frequency value)

Syntax: CFFRQ <s>, <value>[units]
s: A or B
value: 10 kHz to 122 GHz

Remarks: Sets the frequency used to look up the correction data from the sensor's internal table.

Example: Both of the following examples set the frequency for cal source frequency to 25 GHz for sensor A.

```
CFFRQ A,25E9  
CFFRQ A,25GHZ
```

Query: CFFRQ? <s>
Returned String: CFFRQ <s>,<value>

CFSRC (Cal factor source)

Syntax: CFSRC <s>,<source>
s: A or B
source: FREQ MAN VGHZ

Remarks: Sets the source of the calibration factor. Frequency uses the internal EEPROM calibration factor value in the sensor, from the frequency set by the CFFRQ number. Frequencies between Cal Factor data points are interpolated linearly to 0.01 dB resolution. Manual uses the CFCAL number itself. VGHZ takes the frequency from the V/GHz input and uses it to look up the calibration factor from the EEPROM in the sensor.

Related commands: CFVAL

Query: CFSRC? <s>
Returned String: CFSRC <s>,<source>

CFUADD (Add an entry pair to a cal factor table)

Syntax: CFUADD<s>,<table number>,<frequency value>[units],
<cal factor>,<cal factor units>

s: A or B

table number: 1 to number of tables supported by the sensor type

frequency value: 10 kHz to 122 GHz

cal factor: 0.07 to 150% 31.55 to -1.76 dB

cal factor units: %, PCT, DB, or DBM

Remarks: Adds an entry pair to a cal factor table. This only affects the copy of the cal factor table stored in the memory of the power meter. Cal factors entered with this command will be available for use by the DSP, but will NOT be saved to the sensor until a save command (CFUSAV) is executed. If the sensor is changed or power is lost before saving, all changes made since the last CFUSAV will be lost.

The user must ensure that the maximum number of cal factor data pairs entered into a table is not exceeded. Sensors with a maximum frequency of up to 40 GHz will hold 90 pairs, while sensors with a maximum frequency of 50 GHz will hold 110 pairs.

Related commands: CFUSAV

CFUCT (Clear cal factor table)

Syntax: CFUCT <s>,<table number>

s: A or B

table number: 1 to number of tables supported by the sensor type

Remarks: Clears the cal factor table to one entry for 50 MHz at 100%, but does not clear the identity of the table. The cleared table is automatically saved to the sensor.

CFUID (Cal factor table identity update)

- Syntax:** CFUID <s>,<table number>,<identity>
s: A or B
table number: 1 to number of tables supported by the sensor type
identity: Seven characters or until a message terminator will be read as the identity.
- Remarks:** Updates the seven character identity string. This only affects the copy of the cal factor table stored in the memory of the power meter. To take affect and not be lost, the table must be saved to the sensor using the CFUSAV command.
- Query:** CFUID? <s>,<table number>
Returned String: CFUID <s>,<table number>,<identity>

CFUNITS (Cal factor display units)

- Syntax:** CFUNITS <s>,<units>
s: A or B
units: % or PCT dB or dBm
- Remarks:** This command changes the display units of the calfactors between either dB or percentage. Note that this will also set the form the data is output over the GPIB (or RS232) when requested.
- Query:** CFUNITS? <s>
Returned String: CFUNITS <s>,<units>

CFULD (Cal factor table binary load)

- Syntax:** CFULD<s>,<table number>,<length>,<binary data>
s: A or B
table number: 1 to number of tables supported by the sensor type
length: Length of message in bytes
binary data: Same data as that received by CFURD
- Remarks:** Loads binary data into the cal factor table. This command will automatically save the data to the sensor.

CFUPT (Preset cal factor table)

Syntax: CFUPT <s>,<table number>

s: A or B

table number: 1 to number of tables supported by the sensor type

Remarks: Presets the cal factor table to the factory settings. The preset table is automatically saved to the sensor. For a universal sensor, separate cal factor tables exist for option 1 (when fitted) and normal operation. This function will preset the table relating to the currently selected mode.

CFURD (Cal factor table binary read)

Syntax: CFURD<s>,<table number>

s: A or B

table number: 1 to number of tables supported by the sensor type
F for the factory default table

Remarks: This command outputs the cal factor table in binary mode in the following form:

CFURD<space><length of binary data>,<binary data>

<length of binary data>: Total length of the binary data message, in bytes, after the comma.

<binary data>: Made up of:

- a. 8 bytes; 7 for the identity, plus a NULL terminator
- b. 2 bytes representing the number of table pair entries
- c. The cal factor table data in binary form. The binary data is output in entries which are frequency/factor pairs of six bytes. The frequency is held in 32768e-6LONG format and the cal factor in 1024INT format.

To convert these into real numbers the first four bytes of an entry are read into a LONG variable, cast to a float and then divided by 32768e-6 to give a frequency. The last two bytes are then read into the low bytes of a LONG then cast to a float and divided by 1024.

This message can be manipulated to program a different table using the CFULD command.

CFUSAV (Cal factor table save)

Syntax: CFUSAV

Remarks: This command saves the cal factor table currently being edited to the appropriate sensor. Processing may take a couple of seconds. Any command that can select a new sensor and/or cal factor table for changing, will not automatically save any previous changes made. It is the users responsibility to issue a CFUSAV command.

CFUSEL (Select cal factor table)

- Syntax: CFUSEL <s>,<table number>
s: A or B
table number: table number or combination to use
0 = factory default table
1 to 10 = user table being used
11 to 20 = factory table + user table being used
- Remarks: Selects the cal factor table or combination of tables to be used and automatically updates the sensor.
- Example: CFUSEL A,13
Selects the factory table plus user table 3 in sensor A.

CFUTBL (Number of cal factor tables in the sensor)

- Syntax: CFUTBL<s>
s: A or B
- Remarks: Returns the number of cal factor tables available in the selected sensor.

CFUUSE (Number of cal factor table being used)

- Syntax: CFUUSE<s>
s: A or B
- Remarks: Returns a number indicating the cal factor table, or combination of tables, being used by the selected sensor. Possible returned values are:
0 = factory default table
1 to 10 = user table being used
11 to 20 = factory table + user table being used

CFUVLD (Valid cal factor table check)

- Syntax: CFUVLD <s>,<table number>
s: A or B
table number: 1 to number of tables supported by the sensor type
- Remarks: Returns a TRUE if the table number passed is a valid initialized table for the selected sensor. Returns a FALSE if it is not.

CFVAL Current cal factor value

Syntax: CFVAL<s>

s: A or B

Remarks: Returns the cal factor value currently being used for the specified sensor. This will be a fixed value only when in MANUAL cal factor mode, otherwise the value will depend on the frequency entered when cal source is FREQUENCY and the scaled frequency when the cal source is V/GHz.

CFVAL will not return the updated Cal Factor Value if the system is in TR0 Trigger Hold mode. That is, if you change the Cal Factor Frequency and want to read back what the unit has set the Cal Factor to when the system is in TR0 mode, the system will return the last Cal Factor value before you went into TR0 mode.

Also, you may have to wait for approximately 0.25 s after you change the Cal Factor Frequency to read back the Cal Factor Value even when not in TR0, as CFVAL is not updated instantly after you change the Cal Factor Frequency.

This restriction only applies to the CFVAL GPIB command and does not effect any measurement taken. If you are in TR0 mode, change the Cal Factor Frequency, and then take a measurement the Cal factor will be calculated correctly.

Related commands: CFSRC, CFFRQ

CHCFG (Channel input configuration)

Syntax: CHCFG <c>,<config>

c: 1 or 2

config: OFF, A, B, V, A-B, B-A, A/B, B/A

Remarks: A, B, V = Sensor A, Sensor B, or External Volts
(If V is sent when in Profile or Source Sweep mode, an execution error will occur.)
A-B, B-A = Sensor A minus Sensor B, Sensor B minus Sensor A
A/B, B/A = Sensor A divided by Sensor B, Sensor B divided by Sensor A

Example: To set channel 2 to A-B:

CHCFG 1,A-B

Query: CHCFG? <c>

Returned String: CHCFG <c>,<config>

CHRES (Set channel decimal pint resolution)

Syntax: CHRES <c>,<val>
c: 1 or 2
val: 1 to 3

Remarks: Set the number of decimal places displayed for the specified channel. For example, specifying CHRES 1, 1 would yield a display of 1.5 dBm; CHRES 1, 2 would yield 1.47 dBm; CHRES 1, 3 would yield 1.468 dBm. If the number to be displayed is too large for the number of decimal places selected, the decimal places displayed will be reduced so that the display value can be shown.

Query: CHRES? <c>
Returned String: CHRES <c>,<val>

CHUNIT (Set Channel units)

Syntax: CHUNIT <c>, <units>
c: 1 or 2
units: W (Watts), DBM (dB), DBUV (dBmV), DBMV (dBmV)

Remarks: DBM 0dB is equal to 1mW readout mode
W = Watts readout mode
V = Volts readout mode. This selection is automatically made when the channel input configuration is set to External volts (EXT V).
DBUV = dBmV, 0dB is equal to 1mV in readout mode.

Query: CHUNIT? <c>
Returned String: CHUNIT <c>,<units>
When the channel input configuration is set to External volts (EXT V), the returned units are always volts, irrespective of what units have been set.

CONT (Continue)

Syntax: CONT

Remarks: This command will allow the system to continue the startup sequence if there are self test failures other than DSP errors.

Related commands: STERR, START

CUR (Cursor in Power vs. Time and Source Sweep modes)

Syntax:	CUR <cursor>,<fval> cursor: 1 or 2 fval: 0.0 to 1440 min (24 h) in Power vs. Time mode In Source Sweep mode, Power sweep: -120.0 dB to 30.0 dB In Source Sweep mode, Frequency sweep : 10.0 kHz to 122.0 GHz
Remarks:	In Power vs. Time mode, the fval parameter is in minutes. In Source Sweep mode, the fval parameter is in dB or Hz for a power sweep or frequency sweep respectively. Examples: Power vs. Time: Set cursor 1 to 30 s: CUR 1,0.5 Set cursor 2 to 12.5 h: CUR 2,750 Source sweep: Power Sweep, set cursor 1 to 11.5 dB: CUR 1,11.5 Frequency Sweep, set cursor 2 to 15.6 GHz: CUR 2,15.6GHZ
Related commands:	GRDDT, SRCSPFRQ, SRCSTFRQ, SRCSTPWR, SRCSPWR

CURLK (Link cursors in all graphic modes)

Syntax:	CURLK <state> state: ON, OFF
Remarks:	Links the two cursors together on the graph. When either cursor moves left or right, the other cursor follows. Subsequent changes to delay will move both cursors.
Query:	CURLK? Returned String: CURLK <state>

CVSPF (V/GHz calibration factor stop frequency)

Syntax: CVSPF <s>,<val>[units]
s: A or B
val: 10 kHz to 122 GHz

Remarks: Sets the stop frequency of the V/GHz calibration factor settings.

Example: CVSPF A, 20GHZ

Related commands: CVSPV, CVSTF, CVSTV

Query: CVSPF? <s>
Returned String: CVSPF<s>,<val>

CVSPV (V/GHz calibration factor stop voltage)

Syntax: CVSPV <s>,<val>[units]
s: A or B
val: -0.5 to 20.5

Remarks: Sets the stop voltage of the V/GHz calibration factor settings

Related commands: CVSPF, CVSTF, CVSTV

Query: CVSPV? <s>
Returned String: CVSPV <s>,<val>

CVSTF (V/GHz calibration factor start frequency)

Syntax: CVSTF <s>,<val>[units]
s: A or B
val: 10 kHz to 122 GHz

Remarks: Sets the start frequency of the V/GHz calibration factor settings.

Related commands: CVSPV, CVSPF, CVSTV

Query: CVSTF? <s>
Returned String: CVSTF <s>,<val>

CVSTV (V/GHz calibration factor start voltage)

Syntax: CVSTV <s>,<val>[units]
s: A or B
val: -0.5 to 20.5

Remarks: Sets the start voltage of the V/GHz calibration factor settings.

Related commands: CVSPV, CVSPF, CVSTF

Query: CVSTV? <s>
Returned String: CVSTV <s>,<val>

DBLGHT (Battery LCD Back light mode)

Syntax: DBLGHT <mode>
mode: ON, OFF, TIMED

Remarks: Sets the mode of the LCD backlight when under Battery power.
ON = back light is ON all the time
OFF = back light is OFF all the time
TIMED = back light is on for a limited time period set by the DBLTIM command.

Note: Although GPIB is not available under battery operation, the state of this battery-specific parameter can be changed through this GPIB command.

Related commands: DBLTIM

Query: DBLGHT?
Returned String: DBLGHT <mode>

DBLTIM (Auto Backlight OFF timer setting)

Syntax: DBLTIM <val>
val: 1.0 to 100.0 minutes

Remarks: Sets the time limit when the backlight will turn off if the DBLGHT setting is set to TIMED.

Note: Although GPIB is not available under battery operation, the state of this battery-specific parameter can be changed through this GPIB command.

Related commands: DBLTIM?
Returned String: DBLTIM <val>

DCONT (Set Display Contrast)

Syntax: DCONT <val>
val: 1 to 10

Remarks: One is the lightest setting, ten the darkest. The default is five.

Query: DCONT?
Returned String: DCONT <val>

DCONTD (Set display contrast down by one)

Syntax: DCONTD

Remarks: Make the display lighter by lowering the contrast by one level.

DCONTU (Set display contrast up by one)

Syntax: DCONTU

Remarks: Make the display darker by increasing the contrast by one level.

DISP (Display On or OFF)

Syntax: DISP <state>
state: ON or OFF

Remarks: When using GPIB measurement, speed can be increased by not updating the display. This command turns off the display and writes REMOTE across the screen. If the LOCAL soft key is pressed, the system reverts to DISP ON. The restrictions of this mode are:

1. Min max values read via the GPIB are not updated.
2. Relative operation is ignored so that the normal value is given.
3. DISP will not operate when sent via RS232.

Query: DISP?
Returned String: DISP <state>

DPEAK (Peak meter display)

Syntax: DPEAK <mode>

mode: A, B, A&B, OFF

Remarks: Turns the peak meter display on or off for each channel.

A = Sensor A only

B = Sensor B only

A&B = Sensors A and B displayed at the same time

OFF = Turns the peak meter display off.

The peak meter display range covers 12 dB. When above the displayed maximum or below the displayed minimum, the range is switched by 10 dB in the appropriate direction.

Note that in the event that the channel is displaying an alternative measurement (e.g., external volts from the rear panel BNC) the peak meter continues to represent the Sensor A and/or B data. This is very useful for monitoring an external voltage on the meter, while peaking up a response being monitored by a sensor (e.g., RF output).

Query: DPEAK?

Returned String: DPEAK <mode>

DTRGD (Display Trigger Delay)

Syntax: DTRGD <val>

val: 0.0 to 7.0 s

Remarks: The delay time from the trigger point to when the profile starts to be drawn.

Example: DTRGD 1.25MS Sets the display trigger delay to 1.25 ms.

Query: DTRGD?

Returned String: DTRGD <val>

DUTY (Duty cycle)

Syntax: DUTY <s>,<duty_cycle>
s: A or B
duty cycle: 0.1 to 100%

Remarks: Applies a duty cycle to the selected sensor. An offset will be applied based on the entered value.

Example: DUTY A,50
Specifies a duty cycle of 50% that will alter the displayed readings by approximately +3.01 dB.

Related commands: DUTYS

Query: DUTY? <s>
Returned String: DUTY <s>,<duty cycle>

DUTYS (Duty cycle state)

Syntax: DUTYS <s>,<state>
s: A or B
state: ON or OFF

Remarks: Turns on or off the duty cycle for the selected sensor.

Related commands: DUTY

Query: DUTYS? <s>
Returned String: DUTYS <s>,<state>

EMUL (GPIB emulation mode)

Syntax: EMUL <mode>
 mode: ML24XX (Anritsu ML243xA native mode)
 HP436A (Hewlett-Packard)
 HP437B (Hewlett-Packard)
 HP438A (Hewlett-Packard)
 ML4803 (Anritsu ML4803A Series)

Remarks: Set the GPIB emulation to emulate other types of power meters. This command is available in any emulation mode, and resets the whole GPIB interface when the emulation mode is changed.

 When selecting GPIB emulation modes, the instrument configures itself to the preset conditions of the instrument to be emulated. For example, when selecting HP438A emulation, the front panel menus pass through the presets for the HP437B (which presets sensor A to dBm) then selects HP438A emulation (which presets sensor A to Watts).

ENTERR (Entry Error beep)

Syntax: ENTERR <state>
 state: ON or OFF

Remarks: Turns the user entry error warning beep On or Off.

Query: ENTERR?
 Returned String: ENTERR <state>

ERRLST (Returns the DDE error list)

Syntax: ERRLST

Remarks: On detecting a DDE event, this command returns the error list giving the state of the DDE causes. When the error list is read all parts of the list are cleared and will be updated by any further occurrence of the listed events. The ERRLST response is:-

ABCDEFGHIJKLMNO!PPPPPP!QQQQQQ!

A = Sensor A Zero state: 0 - ZERO done, 1 - Not done, 2 - Zero failed. (HP error 01)

B = Sensor B Zero state: 0 - ZERO done, 1 - Not done, 2 - Zero failed. (HP error 02)

C = Sensor A CAL state: 0 - Done, 1 - Failed. (HP error 05)

D = Sensor B CAL state, 0 - Done, 1 - Failed. (HP error 06)

E = Sensor A range hold: 0 - OK, 1 - Over range, 2 - Under range. (HP error 17)

F = Sensor B range hold: 0 - OK, 1 - Over range, 2 - Under range. (HP error 18)

G = Display channel 1 reading out of range; 0 - OK, 1 - Over range, 2 - Under range. (HP error 25)

H = Display channel 2 reading out of range: 0 - OK, 1 - Over range, 2 - Under range. (HP error 25)

I = Display channel 1 illegal log operation: 0 - OK, 1 - Error. (HP error 27)

J = Display channel 2 illegal log operation: 0 - OK, 1 - Error. (HP error 27)

K = Printer error: 0 - OK, 1 - Print error, 2 - Buffer full. 3 - Paper out

L = Sensor A fitted and used state: 0 - Fitted, 1 - Not fitted and used

M = Sensor B fitted and used state: 0 - Fitted, 1 - Not fitted and used

N = Display channel 1 limits state: 0 - Passed, 1 - High limit failed, 2 - Low limit failed

O = Display channel 2 limits state: 0 - Passed, 1 - High limit failed, 2 - Low limit failed.

PPPPPP = Last cause of a GPIB command error

QQQQQQ = Last cause of a GPIB execution error.

Notes: The GPIB command error and GPIB execution error are always enclosed within exclamation marks (!). If no errors have been produced since the last ERRLST was read, the ERRLST will end with '!!!'.

When read for the first time after startup, a sensor may be reported as not fitted even though it is. This is because the error condition of a sensor used in a channel configuration was recorded before the sensor initialization was completed.

If a sensor is not used in a channel configuration, it will be reported as Zeroed, although it may not have been. If the sensor is then used in a channel configuration, it's zero status will be correctly reported.

Related commands: *ESE?, *ESR?

FAST (Operate in non-488.2 compliant mode)

Syntax: FAST <state>
state: ON or OFF

Remarks: This command allows the system, for speed purposes, to send the present system readings directly to the output, with no buffering at all (obeying the rules sent earlier when talk addressed). GPIB 488.2 rules specify that data should only be given after a request. FAST mode allows data to be read without requesting it first (like the HP437/8). The following conditions and restrictions apply:

a.REMOTE is written across the screen, and no screen updates are done.

b.Sensor data for a single sensor only can be output from display channel 1, according to the following rules:

If the input configuration for display channel 1 is set to either OFF or EXT VOLTS, it is set to 'A' and sensor A data is output if a sensor is connected to input A.

If the input configuration for display channel 1 is set to a sensor combination (A-B, A/B, etc.), the configuration is left as is but only the sensor A data is output.

If the input configuration of display channel 1 is set to 'B', sensor B data is output.

c.Output from display channel 2 is set to OFF.

d.Output is in dB only.

e.Sensor OFFSETS are applied.

f.Relative is applied if it is set to on before switching to FAST mode, and if display channel 1 is configured for a single sensor and dB units.

g.No other data output requests are processed while in FAST mode, except for serial poll. FAST mode must be turned off, for example, to ask for the identity data.

h. FAST mode will not operate when sent via RS232.

FBEEP (Fail Beep On/Off)

Syntax: FBEEP <c>,<state>
c: 1 or 2
state: ON or OFF

Remarks: When ON, causes an audio beep every time the limits for the selected channel fail. If FBEEP is ON, and FHOLD is ON, whenever the limits specified for the channel have been exceeded, a beep sounds once every second until FHOLD is turned OFF, or the CLEAR key (CLR) is pressed. The FAIL indication is not affected by the CLEAR key, and can only be cleared by turning FHOLD off. If a limit fail happens again, the alarm sounds again.

Related commands: FHOLD

Query: FBEEP? <c>
Returned String: FBEEP <c>,<state>

FHOLD (Fail indicator Hold)

Syntax: FHOLD <c>,<state>
c: 1 or 2
state: ON or OFF

Remarks: If the high or low limits fail, and this setting is turned on, the fail status continues until the command is turned off. All BNC outputs, beeps and displays continue to be in the 'fail' state until after the OFF is received.

Related commands: FBEEP

Query: FHOLD? <c>
Returned String: FHOLD <c>,<state>

FROFF (Frequency/Offset Display)

Syntax: FROFF <state>
 state:
 ON or OFF

Remarks: This command turns on the top line information text displaying the frequency and offset for the sensors used, similar to the min-max data display except the left hand data is for sensor A and the right hand is for sensor B. This command is only valid if the sensor cal factor source is set to either frequency or V/GHz, and the sensor is used in a displayed channel.

The display is 'FQ nn.nnGHZ OS nnn.nnn' for each sensor.

The frequency (FQ) is the entered frequency if the cal factor source is set to frequency, or the calculated frequency if the cal factor source is V/GHz.

The offset (OS) is the fixed offset if set to fixed, or the offset table interpolated offset value depending on the frequency if the offset for the sensor is set to table. If the offset for that sensor is OFF, dashes are displayed in the OS part of the top line data.

Query: FROFF?
 Returned String: FROFF <state>

FRST (Factory Reset)

Syntax: FRST

Remarks: Resets the ML243xA to the factory default configuration (see Appendix A). Unlike the *RST command, the offset tables are cleared and all external interfaces are reset. Note that any settings in the *ESE and *SRE registers prior to this command will be reset. The equivalent front panel key sequence is System > Setup > PRESET > FACTORY.

GMNMX (Return the minimum and maximum values)

Syntax: GMNMX <c>
 c: 1 or 2

Remarks: When min/max tracking is turned on, this command is used to read the values. The format returned is:
 <min_value>,<max_value>

GPRST (Reset min/max graph)

Syntax:	GPRST
Remarks:	When profile DATA HOLD mode is set to Min/Max points, this command is used to reset the min/max values for each data point.
Related commands:	GRPIX

GRAUTO (Auto scaling)

Syntax:	GRAUTO
Remarks:	Auto scale for all graphic modes (Profile, Source Sweep and Power vs. Time). This command auto scales the y axis only based on the currently displayed data.

GRAVG (Average between profile cursors)

Syntax:	GRAVG <state> state: ON or OFF
Remarks:	Turns on or off averaging between cursors. The data returned by the GRDRQ command includes the average of all data points between the cursors if GRAVG is turned ON.
Related commands:	GRDRQ
Query:	GRAVG? Returned String: GRAVG <state>

GRCP (Connect points on profile)

Syntax:	GRCP <state> state: ON or OFF
Remarks:	When set to ON, creates a line graph by connecting the profile data points together. The default is ON.
Query:	GRCP? Returned String: GRCP <state>

GRDATA (Display Graph Cursor Data)

Syntax: GRDATA <state>
state: ON or OFF

Remarks: Display the graph cursor data readout box. GRDATA must be turned on before attempting to execute the GRDRQ command to send the data over the GPIB. If GRDATA is not on, GRDRQ will produce an execution error in the event status register (ESR).

Related commands: GRDRQ

Query: GRDATA?
Returned String: GRDATA <state>

GRDDT (Power vs. Time data display time)

Syntax: GRDDT <time>,<units>
time: 1 minute to 24 hours (1440 minutes)
units: MIN (minutes), HR (hours)

Remarks: Sets the time period of the x axis in minutes or hours. For example, either of the following statements may be used to set the time period to 2.5 hours:
GRDDT 2.5,HR
GRDDT 150,MIN

Query: GRDDT?
Returned String: GRDDT <time>,<units>

GRDRQ (Return Graph Data readout)

Syntax: GRDRQ

Remarks: Returns the values in the graph data box. GRDATA must be turned on before attempting to execute GRDRQ. The result string is:

```
GRDRQ
<channel_number>,<Cursor_1_dB>,<Cursor_2_dB>,<Delta_power>,
<Delta_time>[,<Average>]
```

<Delta_power> and <Delta_time> are absolute values. <Average> is only present when between cursor averaging is turned ON with the GRAVG command.

If no data is available, that is, a sensor is not fitted, the profile is not triggered, or the Power vs. Time graph has not reached to the cursor, the output for the relevant readout value is 999 output as 9.99e2.

Example result strings might look like:

```
GRDRQ 1, -10.000, -5.000, 5, 1E-03 (cursor average off)
```

```
GRDRQ 1, -10.000, -5.000, 5, 1E-03, -7.5 (cursor average on)
```

Related commands: GRAVG, GRDATA

GRFS (Profile Reference line state)

Syntax: GRFS <state>
state: ON or OFF

Remarks: Turn the profile reference line ON or OFF. The profile reference line is centred between the top and bottom of the display.

Query: GRFS?
Returned String: GRFS <state>

GRMD (Profile, Power vs. Time and Source Sweep Selection)

Syntax: GRMD <c>
c: 1 or 2

Remarks: Selects the channel displayed on the Profile, Power vs. Time and Source Sweep graphs.

Query: GRMD?
Returned String: GRMD <c>

GRPIX (Profile type)

- Syntax: GRPIX <mode>
mode: NORM, MINMAX, MIN, MAX, AVG
- Remarks: Changes the type of graph displayed:
NORM: Profiles the sensor readings vs. time from the triggered point.
MINMAX: Plots both the MIN and MAX values for each point on the graph. If connect points (GRCP) is ON, a vertical bar is drawn between the min and max points.
MIN: Same as NORM, but each point is the minimum value that point has achieved.
MAX: Same as NORM, but each point is the maximum value that point has achieved.
AVG: This position plotted on the chart for an x-axis time slot is the average of all the readings during that x-axis time slot period, and is only available in Power vs. Time mode.
- Query: GRPIX?
Returned String:
GRPIX <mode> (Mode can be AVG in Power vs. Time mode.)

GRPRD (Profile data collection period)

- Syntax: GRPRD <val>[units]
val: 100 ns to 7 s
- Remarks: Sets the time the system will collect data for and scale into the profile graph after a trigger event.
- Example: GRPRD 20US sets the data collection period to 20 microseconds.
- Query: GRPRD?
Returned String: GRPRD <val>

GRPTP (Graph Pretrigger Percentage)

- Syntax: GRPTP <val>[units]
val: 0 to 100
units: PCT
- Remarks: Sets the pre trigger percentage of the profile screen. The percentage of the data collection period that shows pretrigger information if the display trigger delay is 1/PRF.
- Query: GRPTP?
Returned String:
GRPTP <val>

GRSWP (Graph Averaging Number for Profile or Source Sweep)

Syntax:	GRSWP <s>,<val> s: A or B val: 1 to 512
Remarks:	If GRSWS is set to ON, the points on the graph represent the averaged value of that point against its averaged value since either the graph averaging was reset, or since it was turned on.
Related commands:	GRSWR, GRSWS
Query:	GRSWP? <s> Returned String: GRSWP <s>,<val>

GRSWR (Reset Graph Averaging for Profile or Source Sweep)

Syntax:	GRSWR
Remarks:	If the Graph averaging mode in ON, this command resets the data points and restarts the averaging.
Related commands:	GRSWP, GRSWS

GRSWS (Graph Average State for Profile or Source Sweep)

Syntax:	GRSWS <state> state: ON or OFF
Remarks:	Turns Graph Averaging on or off.
Related commands:	GRSWP, GRSWR
Query:	GRSWS? Returned String: GRSWS <state>

GRTMM (Profile Min/Max tracking mode)

Syntax: GRTMM <mode>
 mode: SINGLE, INFINITE

Remarks: Set Minimum and maximum tracking mode between the cursors.
 SINGLE: Resets min and max values after each sweep.
 INFINITE: Never resets the min and max values. The min & max values are updated after each sweep.
 Note: The INFINITE tracking mode can be reset using the MMRST command.

Related commands: MMRST

Query: GRTMM?
 Returned String: GRTMM <mode>

GRYB (Set graph Y-axis bottom scale)

Syntax: GRYB <val>
 val: -150.0 to +250.0

Remarks: It is not necessary to specify units as the displayed units are always assumed. Profile and Source Sweep modes always use dBm, but Power vs. Time mode can also use dBmV or dBmV.

Query: GRYB?
 Returned String: GRYB <val>

GRYT (Set graph Y-axis top scale)

Syntax: GRYT <val>
 val: -150.0 to +250.0

Remarks: It is not necessary to specify units as the displayed units are always assumed. Profile and Source Sweep modes always use dBm, but Power vs. Time mode can also use dBmV or dBmV.

Query: GRYT?
 Returned String: GRYT <val>

GT0 (Set to ignore the Group Execute Trigger (GET) command)

Syntax: GT0

Remarks: The ML243xA will ignore the GET command or a *TRG.

Related commands: *TRG, Group Execute Trigger (GET), GT1, GT2

GT1 (Set 'GET' command to TR1 type (immediate) trigger)

Syntax: GT1

Remarks: When the ML243xA receives a GET or *TRG command, the system will perform a TR1-type trigger command.

Related commands: *TRG, Group Execute Trigger (GET), GT0, GT2

GT2 (Set 'GET' command to TR2 type (settling delay) trigger)

Syntax: GT2

Remarks: When the ML243xA receives a GET or *TRG command, the system will perform a TR2-type trigger command.

Related commands: *TRG, Group Execute Trigger (GET), GT0, GT1

GTARM (Set profile trigger arming)

Syntax: GTARM <state>
state: ON or OFF

Remarks: Sets the profile trigger arming ON or OFF. If set to ON, the system first checks to see if the BNC sweep blanking input is TRUE before it starts to trigger. If set to OFF, the system triggers on whatever trigger source it has been set up for.

Related commands: GTARM?
Returned String: GTARM <state>

Query:

GTDLY (Set profile trigger sample delay)

Syntax: GTDLY <val>[units]
val: 0.0 to 1.0 s

Remarks: Sets the time delay after the display trigger delay to when the system starts to take readings and displaying them. This point is represented by the left most cursor.

Note: Changing the left most cursor or trigger delay time updates either the cursor or the delay time value.

Query: GTDLY?
Returned String: GTDLY <val>

GTGW (Set profile trigger gate width)

Syntax: GTGW <val>[units]
val: 100ns to 7.0 s

Remarks: Sets the time the system uses to perform whatever calculations are set up. The time interval is represented by the space between the left most cursor and the right most cursor. Changing either cursor, or the Gate width value, will update both the cursors and the gate width value. The default gate width value is 20 ms.

Query: GTGW?
Returned String: GTGW <val>

GTLVL (Set profile trigger level)

Syntax: GTLVL <val>
val: -30 to +20 dBm

Remarks: When the system trigger in profile mode is set to either INTA or INTB (internal sensor A or B) it will trigger on a power level given by the sensor. This command sets the level.

Related commands: GTSRC, GTTYP

Query: GTLVL?
Returned String: GTLVL <val>

GTSRC (Set Profile Trigger source)

Syntax: GTSRC <source>
source: INTA, INTB, EXTTTL, MANUAL, CONT

Remarks: INTA = internal sensor A
INTB = internal sensor B
EXTTTL = external BNC TTL trigger input
MANUAL = manual push button trigger
CONT = continuous
MANUAL trigger only functions correctly on non-repetitive sampling, i.e., the PROFILE PERIOD needs to be 6 ms or greater.
The display shows an 'x' marking the trigger point. This trigger point mark rotates as the profile data is updated, changing between 'x' and '+' on each data update. On rapid updates, the trigger point mark may appear like a star (*), as it is rotating so quickly. In manual, external or GPIB triggered displays, the mark rotates at a slower rate and each true data update can be seen.
The GTSRC setting is overridden by the Group Execute Trigger GPIB common command (GET), *TRG, TR0, TR1 and TR2 commands. The TR3 command will return the system to its previous state if the TR0 (Trigger hold) command has been used.

Query: GTSRC?
Returned String: GTSRC <source>

GTTYP (Set profile trigger type)

Syntax: GTTYP <type>
type: RISE, FALL

Remarks: When the profile system trigger source is set to INTA or INTB (Internal A or B) the ML243xA triggers on a power level (GTLVL) rising or falling. This command sets the trigger for a rising or falling edge.

Related commands: GTLVL, GTSRC

Query: GTTYP?
Returned String: GTTYP <type>

GTXTTL (Set profile external trigger edge)

Syntax: GTXTTL <type>
 type: RISE, FALL

Remarks: When the profile system trigger source is set to External TTL, the ML243xA triggers on a TTL level rising or falling. This command sets the trigger for either a rising or falling edge.

Related commands: GTSRC

Query: GTXTTL?
 Returned String: GTXTTL <type>

HLIM (Set High limits)

Syntax: HLIM <c>, <val>
 c: 1 or 2
 val:
 Units Min Max
 dBm -270 220
 dBmV -53.00 147.00
 dB μ V 7.00 207.00
 Watts 0.0 50.0

Remarks: Sets the high limit. The HLIMS command turns the limits on and off. It is not necessary to enter the units as the limit value is checked against the displayed value. Therefore, if the limits have been set for -10 dBm (HLIM 1, -10) and the display units are subsequently changed from dBm to Watts, the system will still check for the reading to rise above -10, even though the display units type has been changed.

Example: The high limit is set to -10 dBm and turned ON. The display is in dBm. A reading of -9.500 dBm would pass. If the display is subsequently changed to Watts, a reading of 112.2 mW would fail, because the DISPLAYED value is higher than -10. Limit checking only uses the displayed value and does not change its value even though the display units have changed.

Related commands: HLIMS

Query: HLIM? <c>
 Returned String: HLIM <c>,<val>

HLIMS (Turn on/off High limits)

Syntax: HLIMS <c>,<state>
c: 1 or 2
state: ON or OFF

Remarks: The HLIMS command turns the limits on and off.

Related commands: HLIM

Query: HLIMS? <c>
Returned String: HLIMS <c>,<state>

HOLD (Graph hold)

Syntax: HOLD <state>
state: ON or OFF

Remarks: This command holds the present graph displayed on the screen and is available in all graph modes. In Profile and Power vs. Time modes, this command will not work when trigger source is set to MANUAL. The held graph can be requested over GPIB by using the OGD or OGBD commands. The same graph data will be held until HOLD is switched off.

Related commands: OGD, OGBD

Query: HOLD?
Returned String: HOLD <state>

IBBLP (Blanking active TTL level)

Syntax: IBBLP <polarity>
polarity: POS (positive, for high TTL level)
NEG (negative, for low TTL level)

Remarks: Changes the expected polarity of the TTL Blanking input signal.

Query: IBBLP?
Returned String: IBBLP <polarity>

KEYCK (Turn key click sound on or off)

Syntax: KEYCK <state>
 state: ON or OFF

Remarks: When ON, an audible annunciator produces a click corresponding to every key press.

Query: KEYCK?
 Returned String: KEYCK <state>

LINK (Trigger linking)

Syntax: LINK <state>
 state: ON or OFF

Remarks: This will link the trigger set-up between Profile mode and Readout mode so that the sample delay and the gate width will agree. A change to the trigger set-up in either Readout or Profile system set-up will affect either display mode.

Query: LINK?
 Returned String: LINK <state>

LLIM (Set Low limits)

Syntax: LLIM <c>,<val>
c: 1 or 2
val:
Units Min Max
dBm -270 220
dBmV -53.00 147.00
dB μ V 7.00 207.00
Watts 0.0 50.0
Volts 0.0 20.0

Remarks: Sets the low limit. The LLIMS command turns the limits on and off. It is not necessary to enter the units as the limit value is checked against the displayed value.

Therefore, if the limits have been set for -10 dBm (LLIM 1, -10) and the display units are subsequently changed from dBm to Watts, the system still checks for the reading to rise above -10, even though the display units type has been changed.

Related commands: LLIMS

Query: LLIM? <c>
Returned String: LLIM <c>,<val>

LLIMS (Turn on/off low limits)

Syntax: LLIMS <c>,<state>
c: 1 or 2
state: ON or OFF

Remarks: The LLIMS command turns the limits on and off.

Related commands: LLIM

Query: LLIMS? <c>
Returned String: LLIMS <c>,<state>

MMRST (Min Max Tracking reset)

Syntax: MMRST <c>
 c: 1 or 2

Remarks: This command resets the min/max values when in 'Readout' or 'Power vs. Time' mode. In profile mode, this command is used to reset the channels min/max values.

MNGDB (Output Min Graph Binary Data)

Syntax: MNGDB

Remarks: Available in graph modes only. Outputs in binary form the min graph data to the GPIB in the long integer form of 1024 bits per dB as a definite length arbitrary block response data. The C programming example 'Binary output decoding' shows how to extract the binary data. The response form is as follows:
 MNGDB <#><length><number_of_bytes><data_byte_1><data_byte_2>
 ...
 <data_byte_n><\n>
 <length> number of ASCII characters make up the number_of_bytes value
 <number_of_bytes> number of bytes of data contained in rest of the string
 <data_byte_n> four of these values makes up the long integer.
 For example: FF FF D1 64 = -11932 As it is based on 1024 per dB, divide by 1024 to get the dB value (-11.652).

MNGD (Output Min Graph Data)

Syntax: MNGD

Remarks: Available in graph modes only. Outputs in ASCII form the min graph data. The format is as follows:
 MNGD
 <number_of_elements>,<element_1>,<element_2>,<element_n>...<\n>
 The first number in the string is the number of elements to follow, and is always 200 for the ML243xA.

MNMXS (Track min and max values)

Syntax: MNMXS <c>,<state>
c: 1 or 2
state: ON or OFF

Remarks: Turns ON or OFF the min/max tracking for the specified channel. The MMRST command resets the values.

Related commands: MMRST

Query: MNMXS? <c>
Returned String: MNMXS <c>,<state>

MODDEL (Modem redial delay time)

Syntax: MODDEL <value>
value: 1 to 10

Remarks: Sets the autodial delay between retries. The value is the number of minutes to delay between each autodial retry after a failure to connect. This interval can be set from 1 to 10 minutes. See Section 5-10 for more information on modem operation.

Query: MODDEL?
Returned String: MODDEL <value>

MODINIT (Initialize modem)

Syntax: MODINIT

Remarks: Initializes the modem connected to the ML243xA serial port. See Section 5-10 for more information on modem operation.

MODLIM (Autodial enable for limits failure)

Syntax: MODLIM <state>
value: TRUE or FALSE

Remarks: When set to TRUE, produces an SRQ and autodials the phone number (set with MODPH) when a channel limits failure occurs. See Section 5-10 for more information on modem operation.

Query: MODLIM?
Returned String: MODLIM <>true> or <>false>

MODPH (Autodial phone number)

- Syntax: MODPH <number_text>
 number text: the number to be dialed
- Remarks: Enter the phone number to be dialed when autodialing is enabled.
 Reads in a string of up to 40 ASCII characters or the end of the message.
 When the number is being dialed, a dot (.) will be interpreted as a
 2-second delay in the dialing sequence; a minus sign (-) will be
 interpreted as wait for another dialing tone. See Section 5-10 for more
 information on modem operation.
- Query: MODPH?
 Returned String: MODPH <number text>

MODPWR (Autodial enable for power on)

- Syntax: MODPWR <state>
 value: TRUE or FALSE
- Remarks: When set to TRUE, produces an SRQ and autodials the phone number
 (set with MODPH) when the ML243xA is powered on. See Section 5-10
 for more information on modem operation.
- Query: MODPWR?
 Returned String: MODPWR <true> or <false>

MODRED (Redial count)

- Syntax: MODRED <count>
 count: 0 to 10
- Remarks: Sets the number of retrys after a failure to connect. The delay between
 retrys is set using MODDEL. See Section 5-10 for more information on
 modem operation.
- Query: MODRED?
 Returned String: MODRED <count>

MODRNG (Autodial enable for range error)

- Syntax: MODRNG <state>
 value: TRUE or FALSE
- Remarks: When set to TRUE, produces an SRQ and autodials the phone number (set with MODPH) when a sensor range error occurs. See Section 5-10 for more information on modem operation.
- Query: MODRNG?
 Returned String: MODRNG <state>

MXGDB (Output Max Graph Binary Data)

- Syntax: MXGDB
- Remarks: Available in graph modes only. Outputs in binary form the max graph data to the GPIB in the long integer form of 1024 bits per dB as a definite length arbitrary block response data. The C programming example 'Binary output decoding' shows how to extract the binary data. The response form is as follows:
- ```
MXGDB <#><length><number_of_bytes><data_byte_1><data_byte_2>
...
<data_byte_n><\n>
```
- <length> number of ASCII characters that make up the number\_of\_bytes value
- <number\_of\_bytes> number of bytes of data contained in rest of the string
- <data\_byte\_n> four of these values make up the long integer.
- For example: FF FF D1 64 = -11932 As it is based on 1024 per dB, divide by 1024 to get the dB value (-11.652).

**MXGD (Output Max Graph Data)**

- Syntax:           MXGD
- Remarks:         Available in graph modes only. Outputs in ASCII form the max graph data. The format is as follows:
- ```
MX
GD<number_of_elements>,<element_1>,<element_2>,<element_n>...<\n>
```
- The first number in the string is the number of elements to follow, and is always 200 for the ML243xA.

O (Return display channel reading)

Syntax: O <c>
c: 1 or 2

Remarks: Readout and Power vs. Time modes only. Returns the next measured reading available in the output buffer from the selected channel. The reading will sit in the output buffer until it is read. If another reading is requested, that reading will be buffered after the previous reading. If the first reading requested is read before another request for data, the output buffer will be empty. The MAV bit in the status byte will always indicate the state of the buffer. The display is updated at a constant rate with available readings if the display is on.

If the selected channel is turned off, an execution error is returned. The returned string is the value plus a line feed (hex 0X0A), no terminators.

OBACM (AC mod output polarity configuration)

Syntax: OBACM <polarity>
polarity: POS (positive)
NEG (negative)

Remarks: Changes the polarity of the AC mod BNC output signal.

Query: OBACM?
Returned String: OBACM <polarity>

OBCH (BNC output port channel configuration)

Syntax: OBCH <port>,<c>
port: 1 or 2
c: 1 or 2

Remarks: This command changes the channel represented by BNC output modes that can take data from either channel 1 or 2, such as “Analog Output” and “Pass/Fail” modes.

Query: OBCH? <port>
Returned String: OBCH <port>,<c>

OBDSP (BNC analog output display stop value)

Syntax: OBDSP <port>,<units>,<val>
port: 1 or 2
units: W (Watts)
DB (dB)
DBM (dB)
DBUV (dBmV)
DBMV (dBmV)
val: 0 to 1 kW
-70 to 47dB
-23 to 94 dBmV
37 to 154 dBmV

Remarks: Sets up the stop value for the analog out scale of the display.

Query: OBDSP? <port>
Returned String: OBDSP <port>,<units>,<val>

OBDST (BNC analog out display start value)

Syntax: OBDST <port>,<units>,<val>
port: 1 or 2
units: W (Watts)
DB (dB)
DBM (dB)
DBUV (dBmV)
DBMV (dBmV)
val: 0 to 1 kW
-70 to 47dB
-23 to 94 dBmV
37 to 154 dBmV

Remarks: Sets up the start value for the analog out scale of the display.

Query: OBDST? <port>
Returned String: OBDST <port>,<units>,<val>

OBMD (BNC output mode select)

Syntax: OBMD <port>,<mode>
 port: 1 or 2
 mode: 'OFF' (output set to ground) port 1 or 2
 'AOUT' (analog scaled output) port 1 or 2
 'PASS/FAIL' (pass/fail) port 1 or 2
 'SIGA' (signal output sensor A) port 1 only
 'LVLA1' Signal channel range 1 amplifier output for sensor A
 'LVLA2' Signal channel range 2 amplifier output for sensor A
 'LVLB1' Signal channel range 1 amplifier output for sensor B
 'LVLB2' Signal channel range 2 amplifier output for sensor B
 'ACMOD' (AC mod output) port 1 only
 'RFB' (RF blanking while zeroing) port 2 only
 'SIGB' (signal output sensor B) port 2 only

Remarks: Changes the type of output selected for the BNC outputs.

Query: OBMD? <port>
 Returned String: OBMD <port>,<mode>

OBPL (BNC pass/fail pass level)

Syntax: OBPL <port>,<level>
 port: 1 or 2
 level: HIGH (TTL high is PASS)
 LOW (TTL low is PASS)

Remarks: Selects the PASS level for the Pass/fail type of output.

Query: OBPL? <port>
 Returned String: OBPL <port>,<level>

OBVSP (BNC analog output stop voltage scale)

Syntax: OBVSP <port>,<val>
 port: 1 or 2
 val: -5.00 to +5.00 Volts

Remarks: Sets up the stop value for the voltage output in analog output mode. Attempting to set the start value to a voltage greater than the stop value, or the stop value lower than the start value, will result in an execution error.

Query: OBVSP? <port>
 Returned String: OBVSP <port>,<val>

OBVST (BNC analog output start voltage scale)

Syntax: OBVST <port>,<val>
 port: 1 or 2
 val: -5.00 to +5.00 Volts

Remarks: Sets up the start value for the voltage output in analog output mode. Attempting to set the start value to a voltage greater than the stop value, or the stop value lower than the start value, will result in an execution error.

Query: OBVST? <port>
 Returned String: OBVST <port>,<val>

OBZL (BNC RF blanking output level when zeroing)

Syntax: OBZL <level>
 level: HIGH (TTL high), LOW (TTL low)

Remarks: Sets the TTL level of the BNC RF blanking output.

Query: OBZL?
 Returned String: OBZL <level>

OFFCLR (Clear an offset table)

Syntax: OFFCLR <val>
 val: 1 to 5

Remarks: Sets all the values in the table specified to 0 dB and 0.00 Hz.

OFFFIX Offset fixed value

Syntax: OFFFIX <s>,<val>[units]
 s: A or B
 val: -200.000 to +200.000
 units: dB

Remarks: The value added to the sensor if the offset type is set to FIXED.

Example: To set the fixed offset for sensor A to -47 dBm:
 OFFFIX A,-47DB

Query: OFFFIX? <s>
 Returned String: OFFFIX <s>,<val>

OFFTBL (Specify the table used to apply offsets to the sensor)

Syntax: OFFTBL <s>, <val>
 s: A or B
 val: 1 to 5

Remarks: If the Offset Type is set to TABLE, use this command to specify which of the five offset tables to apply to the sensor.

 The tables are a set of frequency-against-dB offsets. The offset value used from the table depends on the setting of the frequency correction source. If the source is FREQUENCY, the entered frequency is used to calculate the offset from the table. If the frequency correction source is V/GHz, the frequency value calculated from the supplied ramp input is used to calculate the offset from the table.

 If the frequency does not match any frequency in the table, interpolation is used to calculate the correct offset.

Note: If the frequency is greater than the maximum frequency in the table, the offset value from the maximum table frequency is used. If the frequency is less than the minimum frequency in the table, the offset from the minimum table frequency is used. The frequency comparisons start from the beginning of the table; if the entry is 0 Hz, this is counted as the end of the table.

Query: OFFTBL? <s>
 Returned String: OFFTBL <s>,<val>

OFFTBR (Output an offset table)

Syntax: OFFTBR <val>

val: 1 to 5

Remarks: Outputs the selected offset table. The returned string is constructed as follows:

OFFTBR

#<length><number_of_bytes>,<element1<element2><element>

Where <length> is the character size of the <number_of_bytes> field and <number_of_bytes> is the number of bytes which make up the string after the comma (.). For example:

OFFTBR #41600,<data...>

4 = number of character to read next for the data length

1600 = One thousand and six hundred bytes of data to read in, representing 200 elements placed one after the other without commas.

Each <element> is made up of 8 bytes; the first four bytes are the Frequency and the second four bytes are the corresponding dB value for the Frequency. For example:

<data_element1><data_element2><data_element3> is equal to:

<freq1><dB1><freq2><dB2><freq3><dB3>... is equal to:

<4bytes1><4bytes1><4bytes2><4bytes2><4bytes3><4bytes3>

The 4 byte binary values are 4 bytes single precision floating point binary data. The C programming example 'Binary output decoding' shows how to extract the binary data.

OFFTBU (Updates an offset table)

Syntax: OFFTBU <val>,<bytes>,<binary_data...>

val: 1 to 5

bytes: number of bytes in the binary_data string

binary_data: frequency and dB offset

Remarks: This command updates the offset table specified by <val>.

<bytes> is the number of bytes in the binary_data string and <binary_data> is a string which represents the frequency and the dB offset to apply in the format of: <element1><element2><elementn...>, where <elementn> has four bytes to represent the frequency and four bytes to represent the dB value.

The four byte value can be created by multiplying the floating point number by 1024 and converting the LONG number to an ASCII string.

For example: -10.234 becomes 10479, converted to hexadecimal FFFFD711. See the programming examples for more detail.

OFFTYP (Offset type to use)

Syntax: OFFTYP <s>,<type>

s: A or B

type: OFF, FIXED, TABLE

Remarks: Selects the type of offset to use.

OFF = No offset to be used.

FIXED = Use the fixed value (OFFFIX) specified.

TABLE = Use the Offset table (OFFTBL) specified.

Query: OFFTYP? <s>

Returned String: OFFTYP <s>,<type>

OFFVAL (Sensor Offset Value)

Syntax: OFFVAL <s>

s: A or B

Remarks: Returns the Offset value being applied to the specified sensor.

Related commands: OFFTBL, OFFTYP

OGBD (Output Graph Binary Data)

Syntax: OGBD

Remarks: Output the next complete set of graph data to the GPIB in the long integer form of 1024 bits per dB as a definite length arbitrary block response data. The C programming example 'Binary output decoding' shows how to extract the binary data. The response form is as follows:

```
OGBD <#><length><number_of_bytes><data_byte_1><data_byte_2> ...
<data_byte_n><\n>
```

<length> number of ASCII characters that make up the number_of_bytes value

<number_of_bytes> number of bytes of data contained in rest of the string

<data_byte_n> four of these values makes up the long integer.

For example: FF FF D1 64 = -11932 As it is based on 1024 per dB, divide by 1024 to get the dB value (-11.652).

OGD (Output Graph Data)

Syntax: OGD

Remarks: Outputs the next complete set of graph data.

The format is as follows:

OGD

<number_of_elements>,<element_1>,<element_2>,<element_n>...<\n>

The first number in the string is the number of elements to follow, and is always 200 for the ML243xA.

OGSD (Output Valid Samples Array (Power vs. Time mode only))

Syntax: OGSD

Remarks: A power verses time chart plots the readings on a scrolling chart from left to right. If GRCP (connect points) is on and no new data has been received for a time slot, the graph is plotted with the same value as the previous time slot but the data for that sample position is not marked as valid. This command will read out an array of 1's and 0's that indicate whether the data for that time slot is valid. For example, '1' for valid and '0' for connecting data only.

Because the time between reading the data and reading the valid sample data may shift the valid samples out of sync with the graph read, it is recommended that a 'HOLD ON' be issued before reading the graph and sample data, and a 'HOLD OFF' after. This will make sure that the sample data and the graph data agree.

If not in Power vs. Time mode, this command will set an execution error.

OI (Output device identification)

Syntax: OI

Remarks: Returned format:

<Company name>,<model>,<serial>,<firmware version>

ON (Output number of channel readings)

Syntax: ON <c>,<val>
c: 1 or 2
val: 1 to 1000

Remarks: Readout and Power vs. Time modes only. This command returns the specified number of readings for the specified channel. The readings are first assembled, and then passed to the GPIB as a whole, with a line feed character (hex 0x0a) marking the end of the string.

Example: ON 1, 9

This example will return:

-10.234, -10.234, -10.235, -10.238, -10.250, -10.270, -10.500, -10.934,
-12.234<0x0a>

OPMD (ML243xA operation mode)

Syntax: OPMD <mode>
mode: DIGIT
PROFILE
PWRTIM
SRCSWP

Remarks: This command selects the ML243xA operation mode (data collection method).

DIGIT = digital read out of channel data

PROFILE = profile of graphic display

PWRTIM = graph of channel power versus time

SRCSWP = source sweep graphic display

To use Graph output commands, the ML243xA must be in Profile or Power vs. Time mode. To use the output channel data commands, the ML243xA must be in the digital readout mode.

Related commands: GRMD

Query: OPMD?
Returned String: OPMD <mode>

PRINT (Send details to the connected printer.)

- Syntax: PRINT
- Remarks: The type of printout depends on the operation mode currently selected. In all modes, the printout includes a header with the current sensor settings and measurement channel setups. When in Readout mode, the Channel 1 and Channel 2 values, and the max/min values if present, are printed below the header. In Profile and Power vs. Time modes, a graph is printed out below the header with all the details shown.

PRNSEL (Select the type of printer)

- Syntax: PRNSEL <type>
type: HP340 BJC80
- Remarks: Available printer selections are the HP DeskJet 340 and Canon BJC80. Other 300, 500, 600 Series and later HP printers are typically compatible. If the Canon BJC80 printer is selected, it must be set to EPSON LQ emulation mode for proper operation. Refer to the printer manual for instructions on setting the emulation mode.
- Query: PRNSEL?
Returned String: PRNSEL <printer>

RCD (Range Calibrator data request)

- Syntax: RCD <s>
s: A or B
- Remarks: Returns the results from an Anritsu Range Calibrator run after the Range Calibrator is disconnected from the power meter. While still connected to the Range Calibrator, the results can be printed but not read via GPIB. The results include values for each end of each sensor range and the zero value, and are kept in non-volatile memory until the Range Calibrator is connected and a calibration run again.
- Response format:
'RCD<ws><sensor>,<state>[,<zero value>,<range 1 upper>,<range 1 lower>,<range 2 upper>,<range 2 lower>,<range 3 upper>,<range 3 lower>,<range 4 upper>,<range 4 lower>,<range 5 upper>,<range 5 lower>]'
- <state>: If state is FALSE, no data follows because there are no valid results for this sensor available.
- If state is TRUE, the results for the selected sensor are displayed in the following order:
zero value, range 1 upper, range 1 lower, range 2 upper, range 2 lower, range 3 upper, range 3 lower, range 4 upper, range 4 lower, range 5 upper, range 5 lower.

REL (Relative control)

Syntax: REL <c>,<mode>

c: 1 or 2

mode: 0 Turn OFF

1 Turn ON and reference

2 Turn ON, use old references if not first time.

Remarks: Turns relative ON or OFF, or references the zero point. REL1 and REL2 toggle between relative and absolute measurements. Sending the RELx command when in dB mode will make the meter apply the last used RELATIVE value. This relative value is used thereafter until it is replaced by another one in the same manner. This allows the user to refer to a previously referenced value, without the meter resetting itself back to a 0.00 display.

Query: REL? <c>

Returned String: REL <c>,<mode>

RFCAL (Turn RF reference calibrator ON or OFF)

Syntax: RFCAL <state>

state: ON or OFF

Remarks: Turns on or off the RF reference calibrator.

Query: RFCAL?

Returned String: RFCAL <state>

RGH (Range Hold Sensor)

Syntax: RGH <s>[,<val>]

s: A or B

val: 0 to 5 (0 to 6 for universal power sensor only)
(0 = AUTO)

Remarks: This function is used to toggle a sensor's range hold off or on, to set a specific range to be held, or to select AUTO ranging. RGH sent with only the sensor parameter will toggle the sensor between holding the present operating range and AUTO. If RGH is sent with sensor and value parameters, the sensor range mode will be set to the range value sent.

Query: RGH? <s>

Returned String: RGH <s>,<val>

RSBAUD (RS232 Baud Rate)

Syntax: RSBAUD <val>
val: 12,24,48,96,192 or 384 hundred bits per second

Remarks: Sets the RS232 Baud rate for the rear panel serial port.

Query: RSBAUD?
Returned String: RSBAUD <val>

RSMODE (RS232 Operating Mode)

Syntax: RSMODE <s>
s: EXTCOM
SRCSWP

Remarks: EXTCOM = External communication. GPIB commands are sent and received via an RS232 connection.
SRCSWP = Source sweep. Connected to a sweeper so updates to the sweepers power of frequencies etc. are automatically updated on the ML243xA also.

Query: RSMODE?
Returned String: RSMODE <s>

SECURE (Secure system state)

Syntax: SECURE <state>
state: ON or OFF

Remarks: Normally when the system is powered on the ML243xA returns to the state it was in when it was powered off. This includes all the offset tables, calibration adjust values, etc.
If Secure is set to ON, non-volatile memory is disabled and all stored values are reset to the factory defaults when the system is powered on. As long as this command is ON, the system will load the presets (see Appendix B) every time it is turned ON.

Query: SECURE?
Returned String: SECURE <s>

SENMM (Sensor Measurement mode)

- Syntax:** SENMM <s>,<mode>
s: A or B
mode: DEFAULT (carrier wave)
MOD (modulated average)
CUSTOM (user configurable trigger setup mode)
- Remarks:** Tells the sensor the type of signal it is expecting. This helps the sensor to take the best measurements.
- When LINK is set to OFF, the Sensor Measurement mode changes as requested.
- When LINK is set to ON, Readout mode is temporarily forced to Custom mode, and the Default and Mod Average modes are inhibited. If the SENMM command is sent with the following modes while LINK is set ON:
- 1.DEFAULT: The Sensor Measurement mode will not change. A GPIB error will be raised.
 - 2.MOD: The Sensor Measurement mode will not change. A GPIB error will be raised.
 - 3.CUSTOM: Sets the Sensor Measurement Mode to Custom. If LINK is later set to OFF, the power meter will remain in Custom Mode.
- Normally, when LINK is set ON, and later set OFF, the power meter returns to the sensor measurement mode it was in when LINK was set ON. However, when LINK is ON, SENMM <s>,CUSTOM will set the Sensor Measurement Mode to Custom, and when LINK is later set to OFF, the power meter will remain in Custom Mode.
- Query:** SENMM? <s>
Returned String: SENMM <s>,<mode>

SENMO (Universal Sensor Operation Mode)

- Syntax:** SENMO <s>,<value>
s: A or B
value: TRMS / FCW
- Remarks:** Selects between using a universal power sensor in its normal operating mode (TRMS) and its option 1 mode (FCW). FCW can only be selected if this option is fitted in the power sensor.
- Query:** SENMO? <s>
Returned String: SENMO <s>,<value>

SENSTL (Set Sensor Settle Percentage)

Syntax: SENSTL <s>,<val>
 s: A or B
 val: 0.01 to 10%

Remarks: Sets how long the system waits for the signal to settle. The value parameter is only used in DEFAULT measurement sensor mode. The settling time allows some control over the tradeoff between speed, and the extent to which a measurement has settled to its final value.

Query: SENSTL? <s>
 Returned String: SENSTL <s>,<mode>

SENTYP (Return sensor information)

Syntax: SENTYP <s>
 s: A or B

Remarks: This command returns information on the selected sensor in string format: <sensor type>,<sensor serial>. For example: MA2442A, 003277.

SRCMOD (Source Sweep Mode)

Syntax: SRCMOD <mode>
 mode: FREQ, OWER

Remarks: Determines whether the voltage sweep applied to the V/GHz analog input on the rear panel is interpreted as a frequency or power sweep. The x axis of the graph on the display will be labelled appropriately.

Query: SRCMOD?
 Returned String: SRCMOD <mode>

SRCSPFRQ (Source Sweep Stop Frequency)

Syntax: SRCSPFRQ <freq_value>[units]
 freq value: 10 kHz to 122 GHz

Remarks: Determines the stop frequency when in frequency sweep mode.

Query: SRCSPFRQ?
 Returned String: SRCSPFRQ <frequency>

SRCSPWR (Source Sweep Stop Power)

Syntax: SRCSPWR <power_value>
 power value: power

Remarks: Determines the stop power level of power sweep mode.

Query: SRCSPWR?
 Returned String: SRCSPWR <power>

SRCSTAT (Source Sweep mode status request)

Syntax: SRCSTAT

Remarks: Requests the source sweep status, and returns the following message:
 SRCSWP<ws><mode>,<start_power>,<stop_power>,<start_freq>,<stop_freq>

SRCSTFRQ (Source Sweep Start Frequency)

Syntax: SRCSTFRQ <freq_value>[units]
 freq value: 10 kHz to 122 GHz

Remarks: Determines the start frequency when in frequency sweep mode.

Query: SRCSTFRQ?
 Returned String: SRCSTFRQ <frequency>

SRCSTPWR (Source Sweep Start Power)

Syntax: SRCSTPWR <power_value>
 power value: power

Remarks: Determines the start power level of power sweep mode.

Query: SRCSTPWR?
 Returned String: SRCSTPWR <power>

START (Initial startup self test command)

Syntax: START

Remarks: This is useful for ATE control. After the system has been given time to start up, this command can be used to find out what state the system is in. If the self test has failed, 'CONT' can be used to get the system running. This is an initial startup self test status command and will return one of the following:

- 0 - Passed self test and running.
- 1 - Startup self test running.
- 1 - Start up self test FAILED.

In this stage of the startup process, all commands except STERR, START, CONT and GPIB 488.2 event and status commands will produce a GPIB execution error. STERR will return the selftest result string.

Related commands: STERR, CONT

STATUS (Status Message)

Syntax: STATUS

Remarks: Replies with the power meter's current state code. In this format, the number of letters specifies the number of digits, with preceding zeroes for padding. The format is:

'ABCDEFGHIJKLMNNOOPQRRRRSSSSSTUVWXYZ12'

where:

A = Operating mode: '0' = Digital readout, '1' = Profile mode channel 1, '2' = Profile mode channel 2, '3' = Power vs. Time channel 1, '4' = Power vs. Time channel 2, '5' = Source sweep chan. 1, '6' = Source sweep chan. 2.

B = Channel 1 input configuration: '0' = OFF, '1' = A, '2' = B, '3' = A-B, '4' = B-A, '5' = A/B, '6' = B/A, '7' = EXT Volts.

C = Channel 2 input configuration: '0' = OFF, '1' = A, '2' = B, '3' = A-B, '4' = B-A, '5' = A/B, '6' = B/A, '7' = EXT Volts.

D = Channel 1 units: '0' = dBm, '1' = Watts, '2' = Volts, '3' = dBmV, '4' = dBmV.

E = Channel 2 units: '0' = dBm, '1' = Watts, '2' = Volts, '3' = dBmV, '4' = dBmV.

F = Channel 1 relative status: '0' = Rel OFF, '1' = Rel ON.

G = Channel 2 relative status: '0' = Rel OFF, '1' = Rel ON.

H = Channel 1 low limit state: '0' = OFF, '1' = ON.

I = Channel 1 high limit state: '0' = OFF, '1' = ON.

J = Channel 2 low limit state: '0' = OFF, '1' = ON.

K = Channel 2 high limit state: '0' = OFF, '1' = ON.

L = Sensor A measurement mode: '0' = Default, '1' = MOD average, '2' = Custom.

M = Sensor B measurement mode: '0' = Default, '1' = MOD average, '2' = Custom.

NN = Sensor A range hold: Manual = '01' to '05', AUTO = '11' to '15'.

OO = Sensor B range hold: Manual = '01' to '05', AUTO = '11' to '15'.

P = Sensor A averaging mode: '0' = OFF, '1' = AUTO, '2' = Moving, '3' = Repeat.

Q = Sensor B averaging mode: '0' = OFF, '1' = AUTO, '2' = Moving, '3' = Repeat.

RRRR = Sensor A average number. For Profile and Source Sweep modes, this number is between 1 and 512. For digital Readout or Power vs. Time modes, the values are either 1 to 512 or, if in AUTO averaging mode, 513 to 1024.

: SSSS = Sensor B average number (0000 if ML2437A). For Profile and Source Sweep modes, this number is between 1 and 512. For digital Readout or Power vs. Time modes, the values are either 1 to 512 or, if in AUTO averaging mode, 513 to 1024.

T = Sensor A low level average: '0' = OFF, '1' = Low, '2' = Medium, '3' = High

U = Sensor B low level average: '0' = OFF, '1' = Low, '2' = Medium, '3' = High.

V = Sensor A zeroed status: '0' = Not zeroed, '1' = Zeroed.

W = Sensor B Zeroed status: '0' = Not zeroed, '1' = Zeroed.

X = GPIB trigger mode: '0' = TR0 hold ON, '1' = Free run.

Y = GPIB group trigger mode: '0' = GTO, '1' = GT1, '2' = GT2.

Z = Calibrator state: '0' = OFF, '1' = ON.

1 = GPIB DISP command status: '0' = OFF, '1' = ON.

2 = GPIB FAST status: '0' = OFF, '1' = ON.

STERR (Returns results of POST or *TST?)

Syntax: STERR

Remarks: Returns (<sp> = space):
 'FLASH<sp>0xn timer, CALDAT<sp>0xn timer, PERSON<sp>0xn timer, RAM
 <sp>
 0xn timer, NONVOL<sp>0xn timer, LCD<sp>0xn timer, KBD<sp>0xn timer, DSP
 <sp>
 0xn timer/n'
 FLASH checksum test: 0x0000 = Passed, 0xffff = Failed
 CALDAT checksum test: 0x0000 = Passed, 0xffff = Failed
 PERSONality data: 0x0000 = Passed, 0xffff = Failed
 RAM read/write test: 0x0000 = Passed, 0xffff = Failed
 NONVOL RAM test: 0x0000 = Passed, 0x0001 = Software version fail,
 0x0002 = Current store fail, 0x0004 = Saved store fail, 0x0008 = secure
 mode fail, 0xffff = read failure
 LCD memory test: 0x0000 = Passed, 0xffff = Failed
 KBD stuck key test: 0x0000 = Passed, 0xffff = Failed
 DSP test: 0x0000 = Passed, else FATAL error

Related commands: START, CONT

SYSLD (Load saved setup store over the GPIB)

Syntax: SYSLD <store number>, <data length>, <binary data>
 store number:
 1 to 10
 data length:
 number of bytes of binary data
 binary data:
 Saved data previously read from the meter using the SYSRD command

Remarks: Sets the passed store number to the setup contained in the binary data that was extracted using the SYSRD command.

Related commands: SYSRD

SYSLNM (Saved set naming)

- Syntax: SYSLNM <store number>,<text>
 store number: 1 to 10
 text: text string
- Remarks: This command allows the saved setups to have text associated with them rather than just the 'USED' and 'NOT USED' text.
- Query: SYSLNM? <store number>
 Returned String:
 SYSLNM <store number>,<store name>
 If a store number of 0 is used, then all the store titles will be output in the form:
 SYSLNM 1,<store 1 name>,2,<store 2 name>, ... ,10,<store 10 name>

SYSRD (Output the saved setup over the GPIB)

- Syntax: SYSRD <store number>
 store number: 0 (current setup) or 1 to 10 saved stores
- Remarks: Requests that the saved stored setup is output over the GPIB. This is a BINARY output that allows the stored setup to be programmed into other ML243xA power meters and stores via the SYSLD command. If a request for a store number that has not had a setup stored into it is made, an execution error event will be set in the Event Status Register (ESR).
- The output is in the form:
 SYSRD<ws><#><num_digits><number num_digits long>, <binary data>
 <num_digits> = Number of following digits giving the number of bytes of binary data.
 <number num_digits long> = A number num_digits long giving the number of bytes of binary data.
 <binary data> = Saved setup.
- Related commands: SYSLD

TEXT (User text command)

Syntax:	TEXT <text string> text string: Text string of up to 20 characters
Remarks:	Defines the text string that will be displayed using the TEXTS command.
Related commands:	TEXTS
Query:	TEXT? Returned String: TEXT <text string>

TEXTS (User text display command)

Syntax:	TEXTS <state> state: ON or OFF
Remarks:	This command turns on or off the display of text entered using the TEXT command. Up to 20 characters of user text can be displayed on the top line of the data screen for READOUT, PROFILE and PWRvsTIME display modes.
Related commands:	TEXT
Query:	TEXTS? Returned String: TEXTS <state>

TR0 (Trigger hold mode)

Syntax:	TR0
Remarks:	Sets both channels to trigger hold mode. It does not trigger until it receives a TR1 or TR2 or GET (group executive trigger), *TRG or TR3 command. If it receives a TR3 command it reverts back to the trigger mode it was in before the TR0 command was sent. If the REM line is low, this command has no effect.
Related commands:	TR1, TR2, TR3, *TRG, Group Execute Trigger (GET), GT0, GT1, GT2

TR1 (Trigger immediate)

Syntax:	TR1 <c> c: 1 or 2
Remarks:	Triggers a single reading which is added to the internal digital filter and the updated filter power level is returned on the GPIB. The returned reading differs depending on the operation mode: Readout: 'O' command response Pwr vs. Time: 'O' command response Profile: 'OGBD' command response (binary graph data for example) Source Sweep: 'OGBD' command response (binary graph data for example) After a TR1 command the instrument returns to either TR0 (trigger hold) or TR3 (trigger free run) mode depending on what it was previously set to.
Related commands:	TR0, TR2, TR3, *TRG, Group Execute Trigger (GET), GT0, GT1, GT2

TR2 (Trigger with a settling delay)

Syntax:	TR2 <c> c: 1 or 2
Remarks:	Triggers a fully ranged and settled reading which is returned on the GPIB Bus. If averaging is set to ON, the average buffer will be cleared and filled before the result is returned. The returned reading differs depending on the operation mode: Readout: 'O' command response Pwr vs. Time: 'O' command response Profile: 'OGBD' command response (binary graph data for example) Source Sweep: 'OGBD' command response (binary graph data for example)
Note:	TR2 in Profile and Source Sweep mode is not supported and will revert to a TR1 type measurement. If the channel is set to External Volts, TR2 is not supported (as there is no averaging and settling) and will revert to a TR1 type measurement. After a TR2 command the instrument returns to either TR0 (trigger hold) or TR3 (trigger free run) mode depending on what it was previously set to.
Related commands:	TR0, TR1, TR3, *TRG, Group Execute Trigger (GET), GT0, GT1, GT2

TR3 Trigger free run

Syntax: TR3

Remarks: Sets the ML243xA back into free run mode on both channels.

Related commands: TR0, TR1, TR2, *TRG, Group Execute Trigger (GET), GT0, GT1, GT2

TRGARM (Trigger arming)

Syntax: TRGARM <c>, <state>

c: 1, 2 or 1&2

state: ON or OFF

Remarks: Sets the readout trigger arming ON or OFF when in READOUT or Power vs. Time mode. Select channel 1, 2 or 1&2. Selecting 1&2 allows both channels to trigger together on the same conditions without having to set up two sets of trigger data. If set to ON, the system first checks to see if the BNC sweep blanking input is TRUE before it starts to trigger. If set to OFF, the system uses the trigger source (TRSRC) to decide when to trigger. TRGARM will return an execution error if trying to set trigger arming ON when a display channel trigger source is already set to EXTTTL, as they both use the same BNC input.

Query: TRGARM? <c>

TRGARM <c>,<state>

The TRG type commands return the trigger state of the selected channel if the channel is ON. This depends on the settings of the “link triggers” flag and the current mode of the sensor on the selected channel. If the channel is OFF, the stored trigger state of the channel is returned.

TRGDLY (Trigger sample delay)

Syntax: TRGDLY <c>, <val>[units]
c: 1, 2 or 1&2
val: 0.0 to 1.0 s

Remarks: The time the system waits after a trigger event has happened before taking measurements when in READOUT or Power vs. Time mode.
Select channel 1, 2 or 1&2. Selecting 1&2 allows both channels to trigger together on the same conditions without having to set up two sets of trigger data.

Query: TRGDLY? <c>
Returned String:
TRGDLY <c>,<val>

The TRG type commands return the trigger state of the selected channel if the channel is ON. This depends on the settings of the “link triggers” flag and the current mode of the sensor on the selected channel. If the channel is OFF, the stored trigger state of the channel is returned.

TRGGW (Set trigger gate width)

Syntax: TRGGW <c>,<val>[units]
c: 1, 2 or 1&2
val: 100 ns to 7.0 s

Remarks: The length of time the system uses to collect data when in READOUT or Power vs. Time mode. The default value is 20 ms.
Select channel 1, 2 or 1&2. Selecting 1&2 allows both channels to trigger together on the same conditions without having to set up two sets of trigger data.

Query: TRGGW? <c>
Returned String: TRGGW <c>,<val>

The TRG type commands return the trigger state of the selected channel if the channel is ON. This depends on the settings of the “link triggers” flag and the current mode of the sensor on the selected channel. If the channel is OFF, the stored trigger state of the channel is returned.

TRGLVL (Set trigger level)

Syntax: TRGLVL <c>,<val>
 c: 1, 2 or 1&2
 val: -30 to +20 dBm

Remarks: If the Trigger source is set to INTA or INTB (internal A or B) the system triggers on a rising or falling power level edge. Use this command to set the level the channel must rise above or fall below before it triggers when in READOUT or Power vs. Time mode. Select channel 1, 2 or 1&2. Selecting 1&2 allows both channels to trigger together on the same conditions without having to set up two sets of trigger data.

Query: TRGLVL? <c>
 Returned String: TRGLVL <c>,<val>
 The TRG type commands return the trigger state of the selected channel if the channel is ON. This depends on the settings of the “link triggers” flag and the current mode of the sensor on the selected channel. If the channel is OFF, the stored trigger state of the channel is returned.

TRGMODE (Change trigger mode)

Syntax: TRGMODE <mode>
 mode: IND, COMB

Remarks: Changes the trigger operating mode between INDividual channel trigger setups and COMBined trigger set ups. Individual set up is when the trigger conditions for each channel are setup separately. The combined setup allows both channels to trigger together on the same conditions.

If a channel is OFF or sensors used in both channel configurations do not include a sensor set to CUSTOM measurement mode, the COMBined trigger mode is not allowed, and sending the GPIB command TRGMODE COMB will produce an execution error.

Query: TRGMODE?
 Returned String: TRGMODE <mode>

TRGSRC (Set trigger source)

Syntax: TRGSRC <c>,<source>

c: 1, 2 or 1&2

source: INTA (internal sensor A)

INTB (internal sensor B)

EXTTTL (external BNC TTL trigger input)

MANUAL (manual push button trigger)

CONT (continuous)

Remarks: This command is overridden by the TR0, TR1 and TR2 commands when in READOUT or Power vs. Time mode. If TR3 is sent, the trigger source reverts back to the previously selected type of triggering. Select channel 1, 2 or 1&2. Selecting 1&2 allows both channels to trigger together on the same conditions without having to set up two sets of trigger data.

Query: Query:

TRGSRC? <c> Returned String:

TRGSRC <c>,<source>

The TRG type commands return the trigger state of the selected channel if the channel is ON. This depends on the settings of the “link triggers” flag and the current mode of the sensor on the selected channel. If the channel is OFF, the stored trigger state of the channel is returned.

TRGTYP (Set Trigger type)

Syntax: TRGTYP <c>,<type>

c: 1, 2 or 1&2

type: RISE, FALL

Remarks: Sets the control type of the trigger used when the source is set to either INTA or INTB (internal A or B) in READOUT or Power vs. Time mode. Select channel 1, 2 or 1&2. Selecting 1&2 allows both channels to trigger together on the same conditions without having to set up two sets of trigger data.

Query: TRGTYP? <c>

Returned String: TRGTYP <c>,<type>

The TRG type commands return the trigger state of the selected channel if the channel is ON. This depends on the settings of the “link triggers” flag and the current mode of the sensor on the selected channel. If the channel is OFF, the stored trigger state of the channel is returned.

TRGXTTL (Set external trigger edge type)

Syntax: TRGXTTL <c>,<type>

c: 1, 2 or 1&2

type: RISE, FALL

Remarks: Sets the control type of the external trigger input used when the trigger source is set to EXTITTL in READOUT or Power vs. Time mode. Select channel 1, 2 or 1&2. Selecting 1&2 allows both channels to trigger together on the same conditions without having to set up two sets of trigger data. If external trigger is used on both trigger channels (1 and 2) the same TTL edge MUST be used on both channels.

Query: TRGXTTL? <c>

Returned String: TRGXTTL <c>,<type>

The TRG type commands return the trigger state of the selected channel if the channel is ON. This depends on the settings of the “link triggers” flag and the current mode of the sensor on the selected channel. If the channel is OFF, the stored trigger state of the channel is returned.

VZERO (Zero the BNC input connector)

Syntax: VZERO

Remarks: Zeros the multipurpose BNC connector used for Volts per GHz connection (Analog Input 2). This will calibrate the units to read zero volts on this BNC. During this operation the connector should either not be connected to anything, or should be connected to a 0 Volt source. A settling time must be allowed after this command before reading any other commands.

ZERO (Zero the selected sensor)

Syntax: ZERO <s>

s: A or B

Remarks: Zero out the noise from the selected sensor.

8-9 GPIB Emulation Modes

The ML243xA power meter emulates the GPIB communication of other power meters. The emulation mode can be set through the front panel SYSTEM > more > more > Rear panel > GPIB > MODE menu (see Chapter 4, Operation) or through the GPIB command EMUL. The available emulation modes and command restrictions are:

Table 8-5. Emulation Modes

Power Meter	Command Restrictions
Hewlett-Packard HP436	All commands supported.
Hewlett-Packard HP437	Commands not supported : DN, DU, ERR?, LP, LT, SP, UP and @2.
Hewlett-Packard HP438	Commands not supported : DO, LP1 and LP2.
Anritsu ML4803	Commands not supported : PCT, VSW, RDB, DBV50, DBV75, VLT50 & VLT75.

In some cases, there are differences between the ML243xA in emulation mode and the actual meter being emulated. These differences are presented in the following sections.

Zeroing a Sensor

The time taken for an ML243xA to complete the ZEROing sequence for a sensor differs from the time taken by the emulated power meters. Any GPIB control programs that ZERO the power meter will have no problems with this time difference if the defined ZEROing controls and/or sequences for the device being emulated are followed.

- The HP436 uses the 'Z1T' AUTO ZERO sequence described in the HP436 manual.
- The HP437 and HP438 use bit 1 of the status byte to indicate ZERO or CAL completion.
- The ML4803 uses bit 0 of the status byte to indicate that the ZERO sequence is not complete.

Sensor Ranges

The sensor operating ranges for the ML2430 power meters are different from those of the meters being emulated. Refer to the specific range information for range commands in each emulation section.

Output Format

In the HP437 and HP438, the format of the readings agrees with the format specified in the manuals, which may differ from the output from some HP437 and HP438 units.

For example: -14.236 may be output by the HP437 or HP438 as '-14.236e00' or '-1.4236e+01'. The ML243xA in HP437 or HP438 emulation modes will output as the manual specifies '-1.4236e+01'.

8-10 ML4803A Emulation Commands

This section provides an alphabetical listing of the GPIB commands (mnemonics) used to program the Model ML243xA Power Meter in ML4803A mode. The emulation mode can be set through the front panel SYSTEM > more > more > Rear panel > GPIB > MODE menu or through the GPIB command EMUL.

All ML4803A GPIB commands that use parameters must not have a space between the command header and the parameter. Multiple parameters must be separated by semicolons.

Multiple commands may be sent on the same line, but must be separated by spaces.

The format for ML4803A GPIB commands is:

<command header><parameter 1>;<parameter n>;...

The end of the command text must be terminated with a line feed character (0Ah, decimal 10) or a GPIB End of Transmission State (EOI), or both.

The ML4803A has an array of memory addresses that each hold a structure of four values; Frequency, Cal factor, Offset, and Reference. The data held for an entered frequency is not automatically applied, but only applied if that memory address is called. The frequency value is only a reference to the operator for which the cal factor and other data is relevant. These memory address sets of data are only available via the GPIB in ML4803A emulation mode.

SRQs

The startup and default mode of operation for the ML4803A is to set an SRQ off then on again for every reading when available. This has the affect of pulsing the SRQ line very quickly and would make it very difficult to use the ML4803A with other devices on the GPIB bus that wish to communicate via SRQs. These SRQs can be turned off temporarily by the 'SRQ0' command. The SRQs will start again as soon as any data is requested from the ML4803A.

Status Byte

The following table and diagram define the Status Byte.

Table 8-6. Status Byte

Bit	Definition	Description
Bit 0	Zero execution	Bit set during zeroing. When zeroing is complete the bit is cleared and the ODR bit and RQS bits are reset.
Bit 1	Cal execution	Bit is set during the Cal 0 dBm.
Bit 3	Output data ready	ODR bit is cleared and set for every reading when made. This is done in sync with the RQS bit giving an SRQ.
Bit 5	Command error	Set on receiving an unrecognized command. The bit is cleared by reading the status byte.

Table 8-6. Status Byte

Bit	Definition	Description
Bit 6	RQS bit	Indicates that the device is requiring service (SRQ).

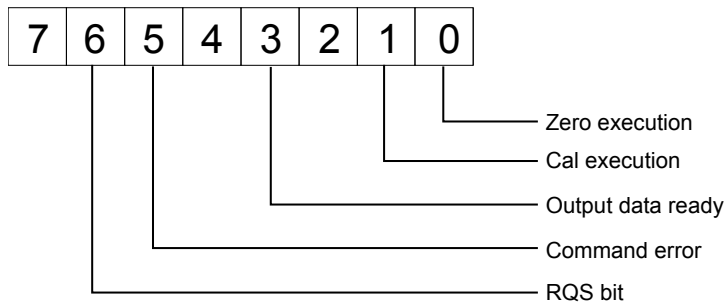
**Figure 8-3.** Status Byte Bits

Output Requests

There are three commands to request output from the ML4803A: OPW for a reading, ODT for the cal factor, offset and reference values, and OMR for memory store settings. If these output requests are received simultaneously, only the data for the command received last will be available.

Unsupported Commands

The following ML4803A commands are not supported in the ML243xA Power Meter GPIB interface:

PCT
 VSW
 RDB
 DBV50
 DBV75
 VLT50
 VLT75

These commands are read in without errors, but are ignored by the system.

AVE (Sensor averaging setting)

Syntax: AVE<number>
number:
0 = Averaging OFF
9 = HOLD. Holds the present averaged reading.
1 = Average for 1 s (ML243xA Repeat average number of 25).
2 = Average for 2 s (ML243xA Repeat average number of 70).
3 = Average for 5 s (ML243xA Repeat average number of 128).
4 = Average for 10 s (ML243xA Repeat average number of 256).

Remarks: The ML4803A averages for a period of time. The ML243xA sets the averaging to repeat averaging for a number of readings.

CAL (Set the user cal factor value)

Syntax: CAL<value>
value: Cal factor value in dB

CCA (Clear the calfactor value to zero)

Syntax: CCA

CDJ (Perform a CAL 0 dBm)

Syntax: CDJ

Remarks: During the cal 0 dBm sequence, the CAL execution bit in the status byte is set. When the CAL operation is completed, the CAL execution bit is cleared.

COF (Clear the offset value to zero)

Syntax: COF

COS (Turn ON the 50 MHz, 0 dBm RF calibrator output)

Syntax: COS

CRF (Clear the reference value to zero)

Syntax: CRF

CST (Turn OFF the 50 MHz, 0 dBm RF calibrator output)

Syntax: CST

DBM (Sets the display channel units to dBm)

Syntax: DBM

DBR (Sets display channel units to dB's and takes the relative value)

Syntax: DBR

Remarks: The relative value is stored as the reference data. The reference value can be independently changed with the GPIB command REF.

EMUL (GPIB emulation mod)

Syntax: EMUL <mode>

mode:

ML24XX (Anritsu ML243xA native mode)

HP436A (Hewlett-Packard)

HP437B (Hewlett-Packard)

HP438A (Hewlett-Packard)

ML4803 (Anritsu ML4803A Series)

Remarks: Set the GPIB emulation to emulate other types of power meters. This command is available in any emulation mode, and resets the whole GPIB interface when the emulation mode is changed.

When selecting GPIB emulation modes, the instrument configures itself to the preset conditions of the instrument to be emulated. For example, when selecting HP438A emulation, the front panel menus pass through the presets for the HP437B (which presets sensor A to dBm) then selects HP438A emulation (which presets sensor A to Watts).

Note: This command must be entered using the 488.2 format; that is, EMUL<ws><mode> (<ws> = white space).

MCA (Set the cal factor value at the specified memory location in dBm)

Syntax: MCA<mem><;><value>

mem: Memory location 1 to 30.

value: Cal factor value in dBm.

Remarks: Set the cal factor value at memory store address <mem> to <value> dBm.

MCC (Clears the cal factor value at the specified memory location)

Syntax: MCC<mem>
 mem: Memory location 1 to 30.

Remarks: Clears the cal factor value at memory store <mem> to 0.0 dBm.

MCO (Clears the offset value at the specified memory location)

Syntax: MCO<mem>
 mem: Memory location 1 to 30.

Remarks: Clears the offset value at memory store <mem> to 0.0 dBm.

MCQ (Clears the frequency value at the specified memory location)

Syntax: MCQ<mem>
 mem: Memory location 1 to 30.

Remarks: Clears the frequency value at memory store <mem> to 0.1 MHz.

MCR (Clears the reference value at the specified memory location)

Syntax: MCR<mem>
 mem: Memory location 1 to 30.

Remarks: Clears the reference value at memory store <mem> to 0.0 dBm.

MCT (Clears all the entries at the specified memory location)

Syntax: MCT<mem>
 mem: Memory location 1 to 30.

Remarks: Clears frequency, cal factor, offset and reference values at memory store <mem>.

MDI (Disable memory store setting and use)

Syntax: MDI

MEN (Enable setting of the memory stores)

Also will apply the last memory store configured)

Syntax: MEN

MFG (Set the frequency value at the specified location in GHz)

Syntax: MFG<mem><;><value>
mem: Memory location 1 to 30.
value: Frequency value in GHz.

Remarks: Set the frequency value at memory store address <mem> to <value> GHz.

MFM (Set the frequency value at the specified location in MHz)

Syntax: MFM<mem><;><value>
mem: Memory location 1 to 30
value: Frequency value in MHz

Remarks: Set the frequency value at memory store address <mem> to <value> MHz.

MOF (Set the offset value at the specified location in dBm)

Syntax: MOF<mem><;><value>
mem: Memory location 1 to 30.
value: Offset value in dBm.

Remarks: Set the offset value at memory store address <mem> to <value> dBm

MRF (Set the reference value at the specified location in dBm)

Syntax: MRF<mem><;><value>
mem: Memory location 1 to 30.
value: Reference value in dBm.

Remarks: Set the reference value at memory store address <mem> to <value> dBm.

ODT (Output the current calibration factor, offset, and reference level)

Syntax: ODT

Remarks: These are output as three separate messages in the output buffer, as shown below:

CAL factor: 18 ASCII characters + <CR><LF>

OFFSET value: 18 ASCII characters + <CR><LF>

REFERENCE level: 19 ASCII characters + <CR><LF>

Note: When the ODT, OMR, and OPW data output commands are received simultaneously, only the command which is received last is valid.

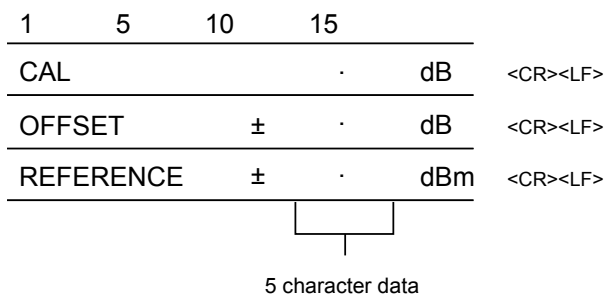

Figure 8-4. ODT Data Output Format

OFF (Set sensor offset value)

Syntax: OFF<value>

value: Offset value to add to the sensor reading.

OI? (Request identity)

Syntax: OI?

Remarks: Response: <ML4803>

The data output codes are as shown in the table below. See the next page for measured data output examples.

Output Code	Contents	Function
V	Measured data valid	STATUS
D	Data range over	
U	Under-range (dBm and dBr)	
O	Over-range	
Z	Zero adjustment	
WATT	Watt	MODE
dBm	dBm	
dBr	dBr	
%	%	
VSWR	VSWR	
dB50	dBu, 50 W system	
dB75	dBu, 75 W system	
VL50	Volt, 50 W system	
VL75	Volt, 75 W system	
	HOLD	RANGE
MRG1	highest sensitivity 1	
MRG2	2	
MRG3	3	
MRG4	4	
MRG5	lowest sensitivity 5	
	AUTO	RANGE
ARG1	highest sensitivity 1	
ARG2	2	
ARG3	3	
ARG4	4	
ARG5	lowest sensitivity 5	
AVE0	OFF	AVERAGE
AVE9	HOLD	
AVE1	1 (1 s interval)	
AVE2	2 (2 s interval)	
AVE3	3 (5 s interval)	
AVE4	4 (10 s interval)	
Space	+	SIGN
	-	
5-1	Numeric data (5 characters) x 10 ^{-(exponent value)}	DATA

Figure 8-7. Data Output Codes

Note When the ODT, OMR, and OPW data output commands are received simultaneously, only the command which is received last is valid.

dBm Mode:

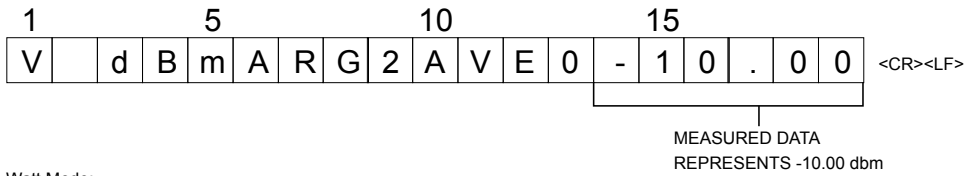

Watt Mode:

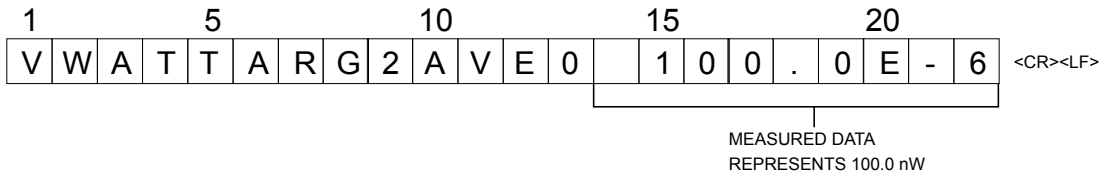

Figure 8-8. Examples, dBm Mode and Watt Mode

As shown in the examples above, the dBm data is output in fixed rotation, while the WATT data is output in scientific notation. The exponent may be converted as follows:

$$1.000\text{W} = 1.000\text{E}-0 \quad 1.000 \mu\text{W} = 1.000\text{E}-6$$

$$1.000 \text{ mW} = 1.000\text{E}-3 \quad 100.0 \text{ nW} = 100.0\text{E}-9$$

$$100.0 \mu\text{W} = 100.0\text{E}-6 \quad 10.00 \text{ nW} = 10.00\text{E}-9$$

$$10.00 \mu\text{W} = 10.00\text{E}-6 \quad 0.100 \text{ nW} = 0.100\text{E}-9$$

For dB (rel), including % and VSWR data, the display data is output in fixed notation just as dBm data is.

REF (Set the reference value)

Syntax: REF<value>
value: Reference value

Remarks: If the display channel is already in relative mode the display value will be updated to be relative to the new reference value set. When the display channel is put into relative mode the reference value will be overwritten with the correct relative value to make the display read 0 dB.

RNG (Sensor measurement range hold)

Syntax: RNG<number>
<number>:
1 = Range 1 (ML243xA range 5)
2 = Range 2 (ML243xA range 4)
3 = Range 3 (ML243xA range 3)
4 = Range 4 (ML243xA range 2)
5 = Range 5 (ML243xA range 1)
A = Auto ranging

Remarks: When the ML2430 is being used to emulate the ML4803, the ranges are reversed; that is, ML4803 range 1 (the lowest power range) is equivalent to the ML243xA range 5, and ML4803 range 5 (the highest power range) is equivalent to the ML243xA range 1.

SRQ (Turns on or off the SRQ on output data ready)

Syntax: SRQ<state>
state: 0 = OFF
1 = ON

Remarks: When SRQ0 is issued, the SRQ will no longer turn off and on with each reading. The SRQ is set back on by the SRQ1 command or by requesting data.

STA (Restart averaging reading)

Syntax: STA

WAT (Sets the display channel units to Watts)

Syntax: WAT

Remarks: Turns off relative mode. Relative is not available in this mode.

ZAJ (Zero the sensor)

Syntax: ZAJ

Remarks: During the zero operation, the zero bit in the status byte is set. When the zero operation is completed, the zero bit in the status byte is cleared.

When emulating the ML4803, the ML2430 may take longer to zero a sensor than the ML4803 itself. When performing a zero, the status byte should be used to identify when zeroing is complete.

8-11 HP436A Emulation Commands

This section provides an alphabetical listing of the commands (mnemonics) used to program the Model ML243xA Power Meter when in HP436A Emulation mode. The emulation mode is set through the front panel SYSTEM > Rear Panel > GPIB > MODE menu or through the GPIB command EMUL.

HP Emulation commands must not have a space between the command header and the parameter, or commas between the parameters.

The format for HP Emulation commands is:

<command header><parameter 1><parameter n>...

The end of the command text must be terminated with a line feed character (0Ah, decimal 10) or a GPIB End of Transmission State (EOI), or both.

+ (Disable cal factor)

Syntax: +

- (Enable cal factor)

Syntax: -

1, 2, 3, 4, & 5 (Set sensor operating range)

Remarks: Range 5 is the highest power range, range 1 the lowest. (These are the opposite to the ML243xA native mode ranges; that is, HP436 range 5 sets to ML243xA range 1, and HP436 range 4 to ML243xA range 2, etc.)

When the ML243xA is being used to emulate the HP436, the ranges are reversed; that is, HP436 range 1 (the lowest power range) is equivalent to the ML243xA range 5, and HP436 range 5 (the highest power range) is equivalent to the ML243xA range 1.

9 (Auto range)

Syntax: 9

Remarks: Sets the ML243xA to automatically select the correct range for the measurement.

A (Wat)

Syntax: A

Remarks: Set units to Watts. Turn relative mode off and do not allow relative.

B (dB (rel))

Syntax: B

Remarks: Set to dB units in relative mode using the present relative reference value.

C (dB (ref))

Syntax: C

Remarks: Set to dB units in relative mode using the present relative reference value, and enable the application of the calfactor.

D (dB)

Syntax: D

Remarks: Set units to dBm.

EMUL (Select emulation mod)

Syntax: EMUL <mode>
mode:
ML24XX (Anritsu ML243xA native mode)
HP436A (Hewlett-Packard)
HP437B (Hewlett-Packard)
HP438A (Hewlett-Packard)
ML4803 (Anritsu ML4803A Series)

Remarks: Sets the GPIB emulation to emulate other types of power meters. This command is available in any emulation mode, and resets the whole GPIB interface when the emulation mode is changed.

When selecting GPIB emulation modes, the instrument configures itself to the preset conditions of the instrument to be emulated. For example, when selecting HP438A emulation, the front panel menus pass through the presets for the HP437B (which presets sensor A to dBm) then selects HP438A emulation (which presets sensor A to Watts).

Note: This command requires a white space between the command header (EMUL) and the parameter <mode>. This is an ML243xA-specific command that does not conform to the HP Emulation command format defined at the beginning of this section.

H (Hold mod)

Syntax: H

Remarks: Sets both channels to trigger hold mode. The power meter does not trigger until it receives an I or T command. If it receives an R or V command, it reverts back to the trigger mode it was in before the H command was sent.

I (Trigger without settling)

Syntax: I

Remarks: Triggers a single reading which is added to the internal digital filter and the updated filter power level is returned on the GPIB. After an I command, the instrument returns to standby mode (H).

OI (Identificatio)

Syntax: OI

Remarks: Ask for identification of current operating mode. Responds with "HP436."

R (Free run mod)

Syntax: R

Remarks: Sets the ML243xA back into free run mode to continuously take measurements and output data.

T (Trigger with settling)

Syntax: T

Remarks: Triggers a new series of readings; enough to update the internal digital filter for a noise free reading at the current power level. The value is then returned on the GPIB and returns to standby mode (H).

V (Free run mode with settling)

Syntax: V

Remarks: Sets the ML243xA back into free run mode to continuously take measurements and output data after running a settling routine.

Z (Zero sensor)

Syntax: Z

Remarks: Zero out the noise from the sensor. When zeroing the ML2430 in HP436 emulation mode, the 'Z1T' sequence followed by the '9+DI' described in the HP436 manual must be followed.

Output Format

The output data format for the HP436A emulation mode is shown below.

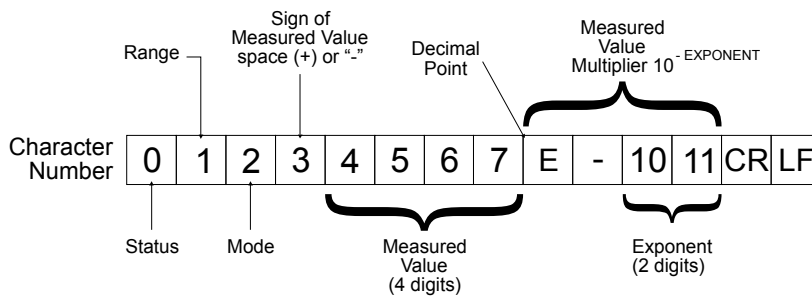

Figure 8-9. HP 436A Output Data Format

The table below describes the HPIB output data format.

Table 8-7. HPIB Output Data Format

Definition	Character	
	ASCII	Decimal
Status		
Measured value valid	P	80
Watts mode under range	Q	81
Over range	R	82
Under range dBm or dB (Rel) mode	S	83
Power Sensor Auto Zero loop enabled; range 1 under range	T	84
Power Sensor Auto Zero loop enabled; not range 1 under range	U	85
Power Sensor Auto Zero loop enabled; over range	V	86
Range		
1 (Most sensitive)	I	73
2	J	74
3	K	75
4	L	76
5 (Least sensitive)	M	77
Mode		
Watt	A	65
dB Rel	B	66
dB ref	C	67
dBm	D	68
Sign of Measured Value		
Space (+)	SP	32
- (minus)	–	45
Measured Value Digits		
0	0	48
1	1	49
2	2	50
3	3	51
4	4	52
5	5	53
6	6	54
7	7	55
8	8	56
9	9	57

8-12 HP437B Emulation Commands

This section provides an alphabetical listing of the commands (mnemonics) used to program the Model ML243xA Power Meter when in HP437B Emulation mode. The emulation mode can be set through the front panel SYSTEM > Rear Panel > GPIB > MODE menu or through the GPIB command EMUL.

HP Emulation commands must not have a space between the command header and the parameter, or commas between the parameters.

The format for HP Emulation commands is:

<command header><parameter 1><parameter n>...

The end of the command text must be terminated with a line feed character (0Ah, decimal 10) or a GPIB End of Transmission State (EOI), or both.

***CLS (Clear GPIB status byte)**

Syntax: *CLS

Remarks: This command performs a status structure clear command. The event status register and the status register are cleared except for the MAV bit.

***ESE (Set the Event Status register enable mask)**

Syntax: *ESE<val>

val: 8-bit mask

Remarks: Event registers for the HP437B.

Bit 7: Power ON

Bit 6: N/A

Bit 5: Command error

Bit 4: Execution error

Bit 3: Device Dependent error

Bit 2: N/A

Bit 1: N/A

Bit 0: N/A

See the HP437B manual for details about the HP status registers.

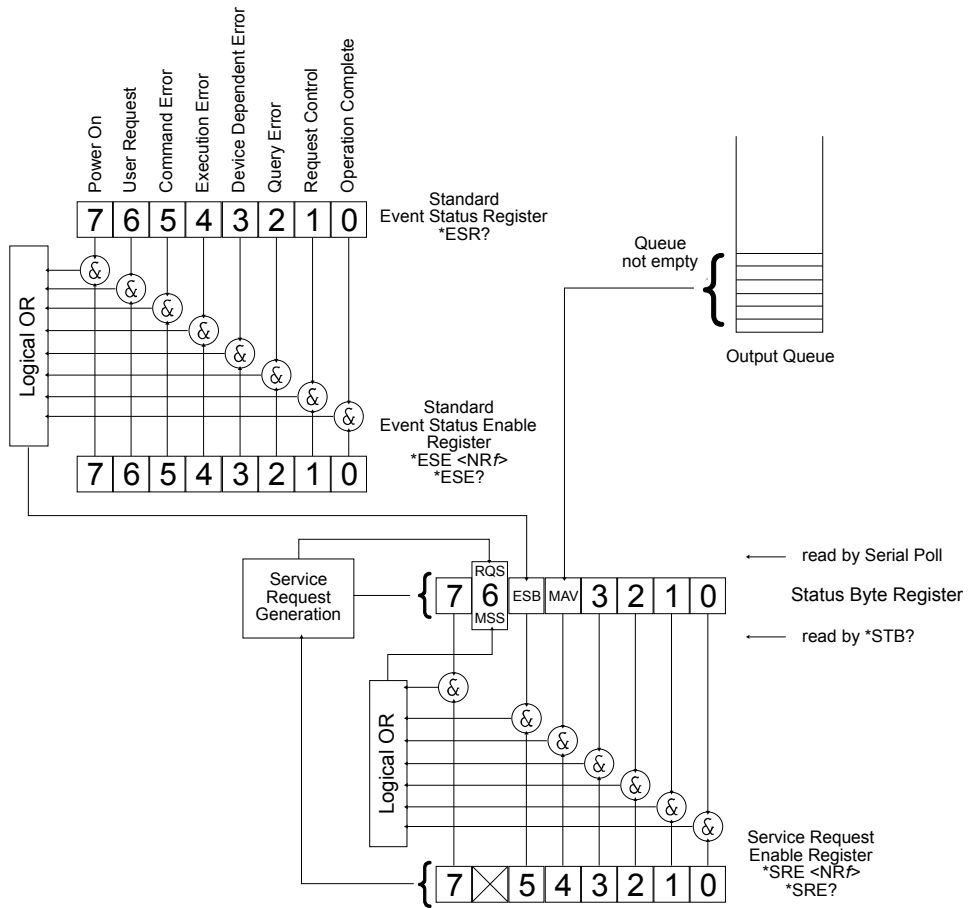

Figure 8-10. IEEE 488.2 Standard Status Structures

***ESE? (Return Event status register enable mask)**

Syntax: *ESE?

Remarks: Returned format: <unsigned character>
When converted to an 8-bit binary number, this byte yields the bit settings of the register.

***ESR? (Event status register request)**

Syntax: *ESR?

Remarks: Return the value of the standard event status register. Afterwards the event status register are cleared. The returned format is: <unsigned character>. When converted to a 8-bit binary number, this byte yields the bit settings of the register.

***RST (Reset Device)**

Syntax: *RST

Remarks: Resets the ML243xA to the default configuration (see Appendix A, Section A-3, or see the HP manual when in HP437B emulation mode). Offset tables are not cleared. The GPIB ADDRESS and EMULATION settings are not changed, and the input queue, output queue, and status registers on the GPIB are not cleared. This command produces the same result as the front panel key sequence System > Setup > PRESET > RESET.

***SRE (Setup service request enable register)**

Syntax: *SRE <val>
 val: 8-bit mask

Remarks: Sets the Service request enable register bits.

***SRE? (Return Service Request Enable register)**

Syntax: *SRE?

Remarks: Returns the Service Request Enable register.

***STB? (Return Status Byte register)**

Syntax: *STB?

Remarks: Returns the status byte value with bit 6 replaced with the MSS value. MSS is the GPIB Master Summary Status, and indicates that the device has at least one reason for requesting service. Although the MSS message is sent in bit position 6 of the device's response to the *STB? query, it is not sent in response to a serial poll and should not be considered part of the IEEE 488.1/2 status byte. MSS = the Status Byte (STB) OR'ed with the Service Request Enable register (SRE). Unlike the *ESR? Command, this command does not clear the register afterwards.

***TST? (Self Test)**

Syntax: *TST?

Remarks: Performs a self test and returns 000.'

Related commands: STERR

@1 (Set SRE mask)

Syntax: @1<val>

val: 8-bit mask

Remarks: Status Byte Structure:
Bit 0: Data ready
Bit 1: Cal/Zero complete
Bit 2: Entry Error
Bit 3: Measurement error
Bit 4: Over/Under limit
Bit 5: Event Status Register
Bit 6: Request Service
Bit 7: N/A

Related commands: RV

CL (Cal Adjust)

Syntax: CL<val><terminator>

val: 50.0 to 120.0

terminator:

%

PCT

EN

Remarks: Same as the ML24XXA (native) CFADJ command. Sets a calibration factor to be used when performing a 0 dBm calibration.

Examples:

CL98.5EN

CL98.5%

CL98.5PCT.

CS (Clear all status byte)

Syntax: CS

Remarks: Same as the *CLS command. Resets all of the GPIB status registers and clears the input queue.

CT (Clear the cal factor table)

Syntax: CT<table_number>

table number: 0 to 9

Remarks: Clears the specified cal factor table to a single 50 MHz entry at 100%. Since the ML243xA stores the cal factor table information in the sensor, this data must be saved to the sensor by using the 'EX' command or an additional command 'SV', or the data could be lost. The saving of the cal factor table data to the sensor can be done at the end of all updates to a particular table.

DA (Display All)

Syntax: DA

Remarks: Turns on all the segments of the display to verify proper operation. The display is returned to normal when another command is sent.

DC (Duty Cycle state)

Syntax: DC<state>
state:
0 = OFF
1 = ON

Remarks: Turns on or off application of the duty cycle to the sensor data.

DD (Display disable)

Syntax: DD

Remarks: Turns the display off to allow faster measurements to be taken.

Related commands: DE, DF

DE (Display enable)

Syntax: DE

Remarks: Return the display to normal operation after the display has been set in DD mode.

Related commands: DD, DF

DF (Display disable)

Syntax: DF

Remarks: Turns the display off to allow faster measurements to be taken.

Related commands: DD, DE

DR (Set GPIB address)

Syntax: DR<val><terminator>
val:
1 to 30
terminator:
EN

Remarks: Changes the device address. The power meter default address is 13.

DY (Duty Cycle)

Syntax: DY<val><terminator>
 val: duty cycle value in percent
 terminator: %, PCT, or EN

Remarks: Sets the duty cycle to be applied to the input signal.

EMUL (GPIB emulation mode)

Syntax: EMUL <mode>
 mode:
 ML24XX (Anritsu ML243xA native mode)
 HP436A (Hewlett-Packard)
 HP437B (Hewlett-Packard)
 HP438A (Hewlett-Packard)
 ML4803 (Anritsu ML4803A Series)

Remarks: Set the GPIB emulation to emulate other types of power meters. This command is available in any emulation mode, and resets the whole GPIB interface when the emulation mode is changed.

When selecting GPIB emulation modes, the instrument configures itself to the preset conditions of the instrument to be emulated. For example, when selecting HP438A emulation, the front panel menus pass through the presets for the HP437B (which presets sensor A to dBm) then selects HP438A emulation (which presets sensor A to Watts).

EN (Enter command)

Syntax: EN

ET (Enter data for a cal factor table)

Syntax: ET<table_number><freq_value><cal factor><terminator>

table number:

0 to 9 (F for factory table allowed when using to read a table)

freq value:

cal factor entry frequency value

cal factor:

cal factor value in percentage

terminator:

EN to terminate and entry

EX to terminate table entries

Remarks: Since the ML243xA stores the cal factor table information in the sensor, this data must be saved to the sensor by using the 'EX' command or an additional command 'SV', or the data could be lost. The saving of the cal factor table data to the sensor can be done at the end of all updates to a particular table.

EX (Exit cal factor table mode)

Syntax: EX

Remarks: Used on the ML243xA to force a save of the cal factor table to the sensor if the data has changed.

FA (Auto average)

Syntax: FA

Remarks: Automatic Filter on. Allows the system to automatically select the filter used to reduce the jitter in the display.

Related commands: FM, FH

FH (average hold)

Syntax: FH

Remarks: Hold filter sets the filter mode to Manual from Auto, but retains the auto filter setting. This function is the same as the AVGM command.

Related commands: FM, FH, FA

FM (Set average value)

Syntax: FM<val>EN

val: 1 to 512

Remarks: Sets the filter length for the averaging of sensor data. For HP437B emulation, the command accepts 1 to 512 in 2-to-the-power steps. For example, 1, 2, 4, 8, 16,...256, 512.

Related commands: FH, FA

FR (Frequency of the input signal)

Syntax: FR<val><units>

val:

units:

GZ (GHz)

MZ (MHz)

KZ (kHz)

HZ (Hz)

EN (Hz)

Remarks: Sets the frequency of the input signal so that the correct cal factor is used.

Example: To set the frequency of the input signal to 300 MHz:
FR300MZ

GT (Set group trigger)

Syntax: GT<mode>

mode:

0

1

2

Remarks: 0 = Ignore Group Execute Trigger (GET) command

1 = Trigger immediate response to 'GET' command

2 = Trigger with delayed response to 'GET' command

The GTn command configures what the device does when it receives the 'GET' command.

For example: GT1 sets the 'GET' (Group Execute Trigger) to perform a TR1 type trigger.

Related commands: TR

ID (Return identification string)

Syntax: ID

Remarks: Returned format:
<company name>,<model>,<firmware version>

IDN? (HP437B identity request)

Syntax: IDN?

Remarks: Returned format:
<company name>,<model>,<firmware version>

KB (Calibration factor)

Syntax: KB<val><terminator>

val:

1.0 to 150.0%

terminator:

%

PCT

EN

Remarks: The calibration factor compensates for mismatch losses and effective efficiency over the frequency range of the power sensor.

Example: KB99.9%
KB99.9PCT
KB99.9EN

LG (Set log units)

Syntax: LG

Remarks: Changes the display to log units (dBm).

LH (Set high limit)

Syntax: LH<val>EN

val:

-200 to +200 (dBm only)

Remarks: Sets the high limit.

Example: LH30.00EN

LL (Set low limit)

Syntax: LL<val>EN

val:

-200 to +200 (dBm only)

Remarks: Sets the low limit.

Example: LL20.00EN

LM (limits check state)

Syntax: LM<state>
state:
0 (off) or 1 (on)

Remarks: Turns limit checking on or off.

LN (Set linear units)

Syntax: LN

Remarks: Changes the display to linear units (Watts).

OC (Set calibrator state)

Syntax: OC<state>
state:
0 (OFF)
1 (ON)

Remarks: For example: OC0 (reference calibrator state set to OFF).

OD (Output the display)

Syntax: OD

Remarks: Outputs a formatted display channel reading in either dBs or Watts. Will also output the cal factor tables, as described below.

The only way to read out the cal factor table data from the HP437 is to send the commands to display each entry on the screen, and then ask for a text display output using the 'OD' command.

The ML243xA supports the 'OD' command to the extent that it will output a formatted display channel reading in either dBs or Watts, and will also output the cal factor tables. After sending the 'ETn' command (n = the cal factor table number) if an 'OD' is sent, the first frequency/cal factor entry of the cal factor table is output in the HP format. If this is then followed by an 'EN' the next cal factor entry pair is available for output, and can be read using the 'OD' command. When all the pairs are output, all further 'ENOD' combinations output a frequency of '00.00 MHz 100.0%'. The EX command terminates this action so that further 'OD' commands now output the display reading in a formatted mode.

If RFnOD (n = cal factor table number) is sent, the 50 MHz cal factor table entry is output.

OF (Offset state)

Syntax: OF<state>

state:

0 (OFF)

1 (ON)

Remarks: For example: OF1 (Turn offsets ON).

OI (Return identification string)

Syntax: OI

Remarks: Returned format:
<company name>,<model>,<firmware version>

OS (Set offset value)

Syntax: OS<val>EN

val: -200 to +200 (dBm only)

Remarks: Specifies the offset applied to the displayed value. Values can be entered in 0.01 dB increments.

Example: OS10.13EN

Set an offset of 10.13 to the displayed value.

PR (Preset the unit)

Syntax: PR

Remarks: Presets the unit to the HP factory defaults. This command does not effect the calibration factors stored in the sensor data tables.

RA (Auto Range)

Syntax: RA

Remarks: Sets the ML243xA to automatically select the correct range for the measurement.

RC (Recall setup)

Syntax: RC<val>EN
val: 1 to 10

Remarks: The ML243xA can store up to 10 instrument configurations for convenient recall. The configuration parameters stored are the same parameters the ML243xA stores in its own *SAV and *RCL native commands. Therefore, RC is equivalent to *RCL, and ST is equivalent to *SAV.

Selecting Register 0 always restores the previous power meter configuration, providing an expedient way to recover from an entry error.

RE (Set decimal point resolution)

Syntax: RE<number>EN
val: 1, 2, or 3

Remarks: Set the number of decimal places displayed.

Example: To set the display resolution to 2 decimal places:
RE2EN

RF (Set the reference cal factor value for a table)

Syntax: RF<table_number><cal_factor>%
table number: 0 to 9
cal factor: 50 to 150
%: terminator

Remarks: Set the reference cal factor value for a table. Since the ML243xA stores the cal factor table information in the sensor, this data must be saved to the sensor by using the 'EX' command or an additional command 'SV', or the data could be lost. The saving of the cal factor table data to the sensor can be done at the end of all updates to a particular table.

RH (Range hold)

Syntax: RH

Remarks: Hold the power meter in the current range. The differences in sensor ranges must be taken into account when the ML2430 is being used to emulate the HP437.

RL (Relative mode)

Syntax: RL<mode>

mode:

0

1

2

Relative mode permits any measurement result to be compared in dB or percent to a reference value. Relative mode can be enabled using the current power reading (RL1) or the previous reference level (RL2).

Successive measurements are displayed relative to this reference value. RL0 disables relative mode.

RM (Range hold set)

Syntax: RM<val>EN

val: 0 to 5

Remarks: Set the range to <val> and then sets range hold. A value of 0 selects Auto Ranging, so that the range will change to take the best measurement automatically.

Example: To set the range to 3:

```
RM3EN
```

Related commands: RH

RV (Service request mask value)

Syntax: RV

Remarks: Read service request mask value. The returned string format is: <integer value>

Converting the integer value into an 8-bit binary number, each bit corresponds to the Service Request mask bits.

SE (Select cal factor table)

Syntax: SE<table_number>EN

table number: 0 to 9

Remarks: Selects the cal factor table to be used.

SM (status message)

Syntax: SM

Remarks: Returns the status message in the format:
AAaaBBCCccDDddEFGHIJKLMNOP<cr><lf>
where:

AA: measurement error code

aa: entry error code

BB: operating mode

CC: sensor A range

cc: 0

DD: sensor A filter

dd: 0

E: linear/log units

F: A

G: pwr ref status

H: REL mode status

I: trigger mode

J: group trigger mode

K: limits checking status

L: sensor A limits status

M: 0

N: offset status

O: duty cycle status

P: measurement units

SN (Cal table identity update)

Syntax: SN<val>
val: up to seven characters

Remarks: Since the ML243xA stores the cal factor table information in the sensor, this data must be saved to the sensor by using the 'EX' command or an additional command 'SV', or the data could be lost. The saving of the cal factor table data to the sensor can be done at the end of all updates to a particular table.

ST (Store setup)

Syntax: ST<val>EN
val: 1 to 10

Remarks: Stores the present configuration to the selected register.

Example: To store the current instrument configuration in register 2:
ST2EN

Related commands: RC

SV (Save cal factor table)

Syntax: SV

Remarks: Since the ML243xA stores the cal factor tables in the sensors, this command forces the edits to a cal factor table to be saved to the sensor. The operation can take a couple of seconds to complete.

TR0 (Trigger hold mode)

Syntax: TR0

Remarks: Sets both channels to trigger hold mode. It does not trigger until it receives a TR1 or TR2 or GET (group executive trigger), *TRG or TR3 command. If it receives a TR3 command it reverts back to the trigger mode it was in before the TR0 command was sent. If the REM line is low, this command has no effect.

Related commands: TR1, TR2, TR3, *TRG, Group Execute Trigger (GET), GT0, GT1, GT2

TR1 (Trigger immediate)

Syntax: TR1

Remarks: Triggers a single reading which is added to the internal digital filter and the updated filter power level is returned on the GPIB. After a TR1 command, the instrument returns to TR0 standby mode.

Related commands: TR0, TR2, TR3, *TRG, Group Execute Trigger (GET), GT0, GT1, GT2

TR2 (Trigger with a settling delay)

Syntax: TR2

Remarks: Triggers a new series of readings; enough to update the internal digital filter for a noise free reading at the current power level. The value is then returned on the GPIB and returns to TR0 standby mode.

Related commands: TR0, TR1, TR3, *TRG, Group Execute Trigger (GET), GT0, GT1, GT2

TR3 (Trigger free run)

Syntax: TR3

Remarks: Sets the ML243xA back into free run mode on both channels.

Related commands: TR0, TR1, TR2, *TRG, Group Execute Trigger (GET), GT0, GT1, GT2

ZE (Zero sensors)

Syntax: ZE

Remarks: Zero all connected sensors. The ML2430, when emulating the HP437, may take longer to Zero a sensor than the HP437 itself. When performing a zero the status byte should be used to identify when ZEROing is complete.

8-13 HP438A Emulation Commands

This section provides an alphabetical listing of the GPIB commands (mnemonics) used to program the Model ML243xA Power Meter when in HP438A Emulation mode. The emulation mode can be set through the front panel SYSTEM > more > more > Rear panel > GPIB > MODE menu or through the GPIB command EMUL.

HP Emulation commands must not have a space between the command header and the parameter, or commas between the parameters.

The format for HP Emulation commands is:

<command header><parameter 1><parameter n>...

The end of the command text must be terminated with a line feed character (0Ah, decimal 10) or a GPIB End of Transmission State (EOI), or both.

The ML243xA in HP438A emulation mode also supports the HP437B cal factor table edit and read commands.

?ID (HP Identity request)

Syntax: ?ID

Remarks: The format of the returned string is:
<Company name>,<model>,<serial>,<firmware version>

@1 (Set SRE mask)

Syntax: @1<val>

val: 8-bit mask

Remarks: Status Byte Structure, HP438A:
Bit 0: Data ready
Bit 1: Cal/Zero complete
Bit 2: Entry Error
Bit 3: Measurement error
Bit 4: Over/Under limit
Bit 5: Event Status Register (HP437B only)
Bit 6: Request Service
Bit 7: N/A

AD (Set display to A – B)

Syntax: AD

Remarks: Display the Input A reading minus the Input B reading.

AP (Set single sensor A display)

Syntax: AP

Remarks: Set the display to output Input A readings.

AR (Set display A / B)

Syntax: AR

Remarks: Display the Input A reading divided by the Input B reading.

BD (Set display B – A)

Syntax: BD

Remarks: Display the Input B reading minus the Input A reading.

BP (Set single sensor B display)

Syntax: BP
Remarks: Display Input B readings.

BR (Set display B / A)

Syntax: BR
Remarks: Display the Input B reading divided by the Input A reading.

CL (Cal Adjust)

Syntax: CL<val><terminator>
val: 50.0 to 120.0
terminator: %, PCT, EN
Remarks: Same as the ML24XXA (native) CFADJ command. Sets a calibration factor to be used when performing a 0 dBm calibration.
Examples: CL98.5EN
CL98.5%
CL98.5PCT

CS (Clear all status bytes)

Syntax: CS
Remarks: Same as the *CLS command. Resets all of the GPIB status registers and clears the input queue.

DA (Display All)

Syntax: DA
Remarks: Turns on all the segments of the display to verify proper operation. The display is returned to normal when another command is sent.

DD (Display disable)

Syntax: DD
Remarks: Turns the display off to allow faster measurements to be taken.
Related commands: DE

DE (Display enable)

Syntax: DE

Remarks: Return the display to normal operation after the display has been set in DD mode.

Related commands: DD

DR (Set GPIB address)

Syntax: DR<val>
val: 1 to 30

Remarks: Changes the device address when operating in HP emulation mode. The power meter default address is 13.

EMUL (GPIB emulation mode)

Syntax: EMUL <mode>
mode:
ML24XX (Anritsu ML243xA native mode)
HP436A (Hewlett-Packard)
HP437B (Hewlett-Packard)
HP438A (Hewlett-Packard)
ML4803 (Anritsu ML4803A Series)

Remarks: Set the GPIB emulation to emulate other types of power meters. This command is available in any emulation mode, and resets the whole GPIB interface when the emulation mode is changed.

When selecting GPIB emulation modes, the instrument configures itself to the preset conditions of the instrument to be emulated. For example, when selecting HP438A emulation, the front panel menus pass through the presets for the HP437B (which presets sensor A to dBm) then selects HP438A emulation (which presets sensor A to Watts).

FA (auto average)

Syntax: FA

Remarks: Automatic Filter on. Allows the system to automatically select the filter used to reduce the jitter in the display.

Related commands: FM, FH

FH (average hold)

Syntax: FH

Remarks: Hold filter sets the filter mode to Manual from Auto, but retains the auto filter setting. This function is the same as the AVGM command.

Related commands: FM, FH, FA

FM (Set average value)

Syntax: FM<val>EN

val: 0 to 9

Remarks: Sets the filter length for the averaging of sensor data. For HP438A emulation, the filter length is defined as the number 2 to the power of <val>. For example, the command FM5EN would be 2^5 , or 32.

Related commands: FH, FA

GT (Set group trigger)

Syntax: GT<mode>

mode:

0

1

2

Remarks: 0 = Ignore Group Execute Trigger (GET) command
1 = Trigger immediate response to 'GET' command
2 = Trigger with delayed response to 'GET' command

The GTn command configures what the device does when it receives the 'GET' command.

For example: GT1 sets the 'GET' (Group Execute Trigger) to perform a TR1 type trigger.

Related commands: TR

KB (Calibration factor)

Syntax: KB<val><terminator>

val: 1.0 to 150.0%

terminator:

%

PCT

EN

Remarks: The calibration factor compensates for mismatch losses and effective efficiency over the frequency range of the power sensor.

Example: KB99.9%
KB99.9PCT
KB99.9EN

LG (Set log units)

Syntax: LG

Remarks: Changes the display to log units (dBm).

LH (Set high limit)

Syntax: LH<val>EN

val: -200 to +200 (dBm only)

Remarks: Sets the high limit.

Example: LH30.00EN

LL (Set low limit)

Syntax: LL<val>EN

val: -200 to +200 (dBm only)

Remarks: Sets the low limit.

Example: LL20.00EN

LM (limits check state)

Syntax: LM<state>

state: 0 (off) or 1 (on)

Remarks: Turns limit checking on or off.

LN (Set linear units)

Syntax: LN

Remarks: Changes the display to linear units (Watts).

OC (Set calibrator state)

Syntax: OC<state>

state:

0 (OFF)

1 (ON)

Remarks: For example: OC0 (reference calibrator state set to OFF).

OI (HP Identity request)

Syntax: OI

Remarks: The format of the returned string is:
<Company name>,<model>,<serial>,<firmware version>

OS (Set offset value)

Syntax: OS<val>EN

val: -200 to +200 (dBm only)

Remarks: Specifies the offset applied to the displayed value. Values can be entered in 0.01 dB increments.

Example: To set an offset of 10.13 to the displayed value:

OS10.13EN

PR (Preset the unit)

Syntax: PR

Remarks: Presets the unit to the HP factory defaults. This command does not effect the calibration factors stored in the sensor data tables. The defaults for the HP438A are:

Measurement mode = Sensor A

Reference Oscillator = Off

Active entry channel = A

Measurement units = Watts

REL mode = off

Measurement parameters (set for Sensor A and Sensor B):

Cal Factor = 100.0%

Cal Adj = 100.0%

Offset = 0.00 dB

RA (Auto Range)

Syntax: RA

Remarks: Sets the ML243xA to automatically select the correct range for the measurement.

RC (Recall setup)

Syntax: RC<val>EN

val: 1 to 10

Remarks: The ML243xA can store up to 10 instrument configurations for convenient recall. The configuration parameters stored are the same parameters the ML243xA stores in its own *SAV and *RCL commands. Therefore, RC is equivalent to *RCL, and ST is equivalent to *SAV.

Selecting Register 0 always restores the previous power meter configuration, providing an expedient way to recover from an entry error.

RH (Range hold)

Syntax: RH

Remarks: Hold the power meter in the current range. The differences in sensor ranges must be taken into account when the ML2430 is being used to emulate the HP438.

RL (Relative mode)

Syntax: RL<mode>

mode:

0

1

2

Remarks: Relative mode permits any measurement result to be compared in dB or percent to a reference value. Relative mode can be enabled using the current power reading (RL1) or the previous reference level (RL2). Successive measurements are displayed relative to this reference value. RL0 disables relative mode.

RM (Range hold set)

Syntax: RM<val>EN

val: 0 to 5

Remarks: Set the range to <val> and then sets range hold. A value of 0 selects Auto Ranging, where the range will change to take the best measurement automatically.

Example: To set the range to 3:

RM3EN

Related commands: RH

RV (Service request mask value)

Syntax: RV

Remarks: Read service request mask value. The returned string format is: <integer value>
Converting the integer value into an 8-bit binary number, each bit corresponds to the Service Request mask bits.

SM (Status Message)

Syntax: SM

Remarks: Returns the status message in the format:
AAaaBBCCccDDddEFGHIJKLMNOP<cr><lf>
where:

- AA: measurement error code
- aa: entry error code
- BB: operating mode
- CC: sensor A range
- cc: sensor B range
- DD: sensor A filter
- dd: sensor B filter
- E: measurement units
- F: active entry channel
- G: OSC status
- H: REL mode status
- I: trigger mode
- J: group trigger mode
- K: limits checking status
- L: sensor A limits status
- M: sensor B limits status
- others not used

ST (Store setup)

Syntax: ST<val>EN
val: 1 to 10

Remarks: Stores the present configuration to the selected register.

Example: To store the current instrument configuration in register 2:
ST2EN

Related commands: RC

TR0 (Trigger hold mode)

Syntax: TR0

Remarks: Sets both channels to trigger hold mode. It does not trigger until it receives a TR1 or TR2 or GET (group executive trigger), *TRG or TR3 command. If it receives a TR3 command it reverts back to the trigger mode it was in before the TR0 command was sent. If the REM line is low, this command has no effect.

Related commands: TR1, TR2, TR3, *TRG, Group Execute Trigger (GET), GT0, GT1, GT2

TR1 (Trigger immediate)

Syntax: TR1

Remarks: Triggers a single reading which is added to the internal digital filter and the updated filter power level is returned on the GPIB. After a TR1 command, the instrument returns to TR0 standby mode.

Related commands: TR0, TR2, TR3, *TRG, Group Execute Trigger (GET), GT0, GT1, GT2

TR2 (Trigger with a settling delay)

Syntax: TR2

Remarks: Triggers a new series of readings; enough to update the internal digital filter for a noise free reading at the current power level. The value is then returned on the GPIB and returns to TR0 standby mode.

Related commands: TR0, TR1, TR3, *TRG, Group Execute Trigger (GET), GT0, GT1, GT2

TR3 (Trigger free run)

Syntax: TR3

Remarks: Sets the ML243xA back into free run mode on both channels.

Related commands: TR0, TR1, TR2, *TRG, Group Execute Trigger (GET), GT0, GT1, GT2

ZE (Zero sensors)

Syntax: ZE

Remarks: Zero all connected sensors. The ML2430, when emulating the HP438, may take longer to Zero a sensor than the HP438 itself. When performing a zero the status byte should be used to identify when ZEROing is complete.

8-14 Programming Examples

The following programming examples are provided as a general guideline on how to program the ML243xA Power Meters using GPIB commands. All examples are written in Visual Basic or C language. The GPIB-specific calls are for the National Instruments GPIB DLL.

Refer to the IEEE 488.2-1987 Programming Reference book for more information about how to use the 488.2 commands.

Output Data

Function GetReading (ByVal channel As Integer) As Single

```
' make space for the result
Dim result As String
result = String$(10, 0)

' Set the command up
Cmd = "O " + Str(channel) : CmdLength = Len(Cmd)

' Send the command to the device at address 13
' (default address of the power meter)
Call DLLsend(0, 13, Cmd, CmdLength, NLen, ibsta%,
iberr%, ibcntl&)

' Receive the data from ML2430A at address 13
Call DLLreceive(0, 13, result, 10, STOPend, ibsta%,
iberr%, ibcntl&)

' Pass result back
GetReading = Val(result)

End Function
```

Get Graph Data

```

Function GetGraphData ()
` function assumes that you have the graph display
` setup and that there is a global array called
` Graph_Data().
    ` make space for the result
    Dim result As String
    result = String$(2048, 0)
    ` set up a 2K buffer for the data to put in.
    ` Set the command up
    Cmd = "OGD" : CmdLength = Len(Cmd)
    ` Send the command to the device at address 13
    ` (default address of the power meter)
    Call DLLsend(0, 13, Cmd, CmdLength, NLend, ibsta%,
    iberr%, ibcntl&)
    ` Receive the data from ML2430A at address 13
    Call DLLreceive(0, 13, result, 2048, STOPend, ibsta%, iberr%,
    ibcntl&)
    result = Left(result, ibcntl&) - 1
    ` Get number of elements
    Number_of_elements = Val(Mid(result, 5, InStr(5, result, ",") - 5))
    ` redimension our global array
    ReDim GraphData(1 To Number_of_elements) As Single
    ` format the result string so that we only have
    ` the elements.
    result = Right(result, Len(result) - InStr(5, result, ","))
    ` loop through elements and place into our global array
    For I = 1 To Number_of_elements
        next_place = InStr(result, ",") - 1
        If next_place = -1 Then next_place = Len(result)
        GraphData(I) = Val(Mid(result, 1, next_place))
        ` reduce the elements by one
        ` (the one we have just put in the array)
        result = Right(result, Len(result) - InStr
        (result, ","))
    Next I
End Function

```

Status Register Control

This function demonstrates how to use the Status Registers to provide synchronization. Uses the TR2 (trigger with settling) command to make a reading.

Function GetTR2Reading (channel) As Single

```

    ` make space for the result
    Dim result As String
    result = String$(10, 0)

    ` Send Status Register setup command + TR0 hold trigger mode
    Call DLLsend(0, 13, "*SRE 16; TR2 1", 14, NLend, ibsta%, iberr%,
    ibcntl&)

    ` Set loop flag
    Value = -256

    Do

        ` Loop until SRQ is asserted.
        Do
            Call DLLTestSRQ(0, SRQ%, ibsta%, iberr%, ibcntl&)
        Loop Until SRQ%=0

        ` SRQ asserted, read the ML2430As status register
        Call DLLReadStatusByte(0, 13, status_byte%, ibsta%, iberr%,
        ibcntl&)

        ` Check if it is the ML2430A which is requesting
        ` service (SRQ bit + MAV bit)

        If (status_byte% And 80) = 80 Then

            ` It is the ML2430A, read back value
            Call DLLreceive(0, 13, result, 10, STOPend,
            ibsta%, iberr%, ibcntl&)
            Value = Val(result)

        End If

        Loop Until Value <> -256

        GetTR2Reading = Value

    End Function

```

488.2 General Send/Receive System

This function uses the status registers to synchronize the GPIB commands and return data if a query command was used. The system waits until the command string has been completed and then checks to see if any data is on the GPIB output buffer. If so, the data is returned in the Result\$ argument and any error code generated in receiving the data is returned in the Result_Code% argument.

For example: Use 4882SendReceive(0, 13, "O 1", Result\$, Result_Code%) to return a reading from the ML243xA.

Note that this function is written in "pseudo code" and cannot be executed as is.

Function 4882SendReceive (Board%, Addr%, cmdstring\$, Result\$, Result_code%) as integer

```

` Set up SRE and ESE values first, then process User
` commands, then do *OPC
cmd$ = "*ESE 49; *SRE 48; " + cmdstring$ + "; *OPC"
` Send the command string
Call DLLsend(Board%, Addr%, cmd$, Len(cmd$), Nlend,
ibsta%, iberr%, ibcntl&)
` Wait for either the MAV_bit (Message Available)
` or/and the ESB_bit (*OPC)
WaitSRQ(Board, Address, MAV_bit + ESB_bit, stb)
If (stb And MAV_bit) Then
    ` Read the data string out from the ML2430A
    Result_Code% = ReadML2430A(Board, Address, Result$)
    ` If we did not have the ESB_bit set, wait for
    ` it again (*OPC will set this)
    If (stb And ESB_bit) = 0 Then WaitSRQ(Board, Address,
    ESB_bit, stb)
End if
` Check if anything went wrong by asking for the ESB register
Call DLLsend(Board, Address, "*ESR?", 5, Nlend, ibsta%, iberr%,
ibcntl&)
` Wait for it to return the data on the output queue.
WaitSRQ(Board, Address, MAV_bit, stb)
ReadML2430A(Board, Address, ESB)
` Read the ESB value
` Check the ESB for the OPC bit being set
` (pending commands complete).
If (Val(ESB) and 1) Then
    4882SendReceive = True
    ` Everything sent
end if
` Now check if anything has gone wrong.
If (Val(ESB) And CMD_ERR_bit) Then
4882SendReceive = Command_Error
ElseIf (Val(ESB) And EXEC_ERR_bit) Then
4882SendReceive= Execution_Error
ElseIf (Val(ESB) And DEVICE_ERR_bit) Then
4882SendReceive = Device_dependent_Error
End If
End Function

```

Binary Output Message Decoding

The following program example may be used to decode the three types of binary output messages. The commands that reference this code example are OGBD, MXGDB and MNGDB for the GRAPH_BINARY_DATA decoding; OFFTBR for the OFFSET_TABLE_BINARY_DATA decoding; and CFURD for the CAL_FACTOR_BINARY_DATA decoding.

```

/*****
/* Decode binary outputs example*/
/* This function expects the binary response from the command to be
held in a global */
/* character array buffer. The passed parameter 'decode type' will
be one of the global */
/* definitions*/
/* GRAPH_BINARY_DATA*/
/* OFFSET_TABLE_BINARY_DATA, CAL_FACTOR_BINARY_DATA*/
*****/
void buffer_decode(int decode_type)
{
    int count;
    long *bin_value;
    char *cptr;
    char ch_val[6];
    int length;

    if (decode_type == GRAPH_BINARY_DATA)
    {
/* FOR OGBD, MXGDB and MNGDB */
/***** Decode header *****/

        /* Find # character. */
        cptr = strtok(&buffer[0], "#");
        cptr = strtok(NULL, "#");

        /* Get the number of characters for binary length */
        ch_val[0] = *cptr++;
        ch_val[1] = NULL;
        count = atoi(&ch_val[0]);

```



```

/* Get length of binary data */
for (loop = 0; loop < count; loop++)
{
ch_val[loop] = *cptr++;
}
ch_val[count] = NULL;
length = atoi(&ch_val[0]);

/* If reading in a binary graph the data will be in */
/* 1024LONG format. In this format each of the graph */
/* values are held as the dB value multiplied by 1024 */
/* and held in LONG form. */
/**/
/* Each long is 4 byte in length. To read and transpose
the values into real dB values each set of 4 bytes
are read into a long variable and then cast into a
float type and then divided by 1024.
*/
count = 0;
loop = 0;
bin_value = (long *)cptr; /* Set the long pointer */

/* Read and cast the data */
while (count < length)
{
real_data1[loop++] = ((float)(*bin_value++))/1024.0;
count += 4;
}
real1_entries = loop;
}
else if (decode_type == OFFSET_TABLE_BINARY_DATA)
{
/* Decode header */
/* Find # character. */
cptr = strtok(&buffer[0], "#");

```

```
cptr = strtok(NULL, "#");

/* Get the number of characters for binary length */
ch_val[0] = *cptr++;
ch_val[1] = NULL;
count = atoi(&ch_val[0]);

/* Get length of binary data */
for (loop = 0; loop < count; loop++)
{
ch_val[loop] = *cptr++;
}
ch_val[count] = NULL;
length = atoi(&ch_val[0]);

*cptr++; /* Read past comma for offset tables. */

/* The binary offset table is 200 sets frequency and dB */
/* These are held in single precision floating point. */
/* To convert to the real values, re-order the bytes. */
/* */
count = 0;
loop = 0;

while (count < length)
{
/* Frequency conversion */
bin_data.cval[2] = *cptr++;
bin_data.cval[3] = *cptr++;
bin_data.cval[0] = *cptr++;
bin_data.cval[1] = *cptr++;

real_data1[loop] = bin_data.fval;

/* dB conversion */
bin_data.cval[2] = *cptr++;
```

```
bin_data.cval[3] = *cptr++;
bin_data.cval[0] = *cptr++;
bin_data.cval[1] = *cptr++;

real_data2[loop++] = bin_data.fval;
count += 8;
}
real1_entries = loop;
real2_entries = loop;
}
else if (decode_type == CAL_FACTOR_BINARY_DATA)
{
/* Decode header */
/* Read length of binary data*/
ch_val[0] = buffer[6];
ch_val[1] = buffer[7];
ch_val[2] = NULL;
length = atoi(ch_val);

/* Point after the comma */
cptr = &buffer[9];

/* Read the table identity */
count = 8;
for (loop = 0; loop < count; loop++)
{
ident[loop] = *cptr++;
length--;
}
ident[count] = NULL;

/* Read number of entries*/
bin_data.cval[0] = *cptr++;
bin_data.cval[1] = *cptr++;
bin_data.cval[2] = 0;
bin_data.cval[3] = 0;
```

```
table_entries = bin_data.ival;
length -= 2;

/* The cal factor table output is in frequency, dB order for */
/* the whole table. The frequencies format is */
/* 32768.0e-6LONG and the dBs are held in 1024INT format.*/
/**/
count = 0;
loop = 0;

while (count < length)
{
/* Frequency conversion */
bin_data.cval[0] = *cptr++;
bin_data.cval[1] = *cptr++;
bin_data.cval[2] = *cptr++;
bin_data.cval[3] = *cptr++;

real_data1[loop] = ((float) (bin_data.lval))/32768e-6;

/* dB conversion */
bin_data.cval[0] = *cptr++;
bin_data.cval[1] = *cptr++;
bin_data.cval[2] = 0;
bin_data.cval[3] = 0;

real_data2[loop++] = ((float) (bin_data.ival))/1024.0;
count += 6;
}
real1_entries = loop;
real2_entries = loop;
}
```

Appendix A — Technical Support

A-1 Getting Support

Whilst every effort has been made to ensure the quality and reliability of this product, there may be times when operation difficulties are experienced and technical support is required.

Technical support can be obtained from your local sales and service center by visiting <http://www.anritsu.com/contact.asp>

Be prepared to supply the following information:

- Product model
- Power meter serial number
- Sensor model
- Sensor serial number
- Firmware version
- DSP and FPGA sub version
- Description of the problem
- List of error messages
- Description of steps required to reproduce the problem
- Actions already taken to correct the problem

Every effort will be made to ensure that you are contacted within one working day.

Appendix B — Specifications

This appendix provides a listing of system configurations, defaults, and error messages for the ML243xA Power Meters.

B-1 System Configuration

Display:	LCD Graphic display with dual channel readout mode and dual peak meters. Backlight and adjustable contrast standard.
Save/Recall:	
Setup Memory:	10 storage registers plus RESET default settings
Secure Mode:	Erases memory information upon power ON. Default condition is Secure Mode OFF.
Rear Panel Inputs/Outputs	
Cal Factor Voltage Input (BNC):	Operating Modes: Voltage: Display voltage reading on selected channel. Voltage proportional to frequency for sensor calibration factor compensation. Blanking Input: TTL levels only. Selectable positive or negative polarity.
Input Range: 0 to 20 V:	Resolution: 0.5 mV
Control:	Adjustable voltage to frequency relationship
Analog Output (BNC):	Two outputs configurable to Log or Lin
Operating Modes:	Analog Out: Selectable channel adjusted for calibration factors and other power reading correction settings. Pass/Fail: Selectable TTL High or Low Channel output: Near real time analog. Uncalibrated. AC Modulation Output: Output 1 only.
Output Range:	-5.0 V to 5.0 V
Resolution:	0.1 mV
Trigger Input:	
Operating Modes:	External TTL or RF Blanking.
GPIO Interface:	IEEE-488.2 and IEC-625. Implements AH1, SH1, T6, LE0, SR1, RL1, PP0, DC1, DT1, C0 and E1.

System Configuration

RS232:	Supports software download and GPIB commands.
Parallel Printer Output:	Compatible with HP Deskjet 540 and 310 Models other 500 Series and 300 Series and later are typically compatible. Also canon BJC 80. See manual for DIP switch settings.
General Specifications	
General:	MIL-PRF-28800F, class 3
Display:	Flat panel monochrome LCD graphic with backlight.
Operating Temperature Range:	0 to 50 °C (32 to 122 °F)
Storage Temperature Range:	-40 to +70 °C (-40 to +156 °F)
Moisture:	Splash and rain resistant, 90 % humidity, non-condensing
Power Requirements:	AC: 85 to 264 VAC, 47 to 440 Hz, 40 VA Maximum DC: 12 to 24 VDC, reverse protected to -40 Maximum input 30 V Battery: > 4 hours usable with 3000 mAh battery and display backlight on.
Replaceable Battery (optional):	Energizer model NJ1020 3000 mAh, Ni-MH (option 2000-996-R)
EMI:	Complies with requirements for CE marking.
Warranty:	3 year standard.
External Dimensions:	Depth: 15.310" (38.887 cm), Height: 4.060" (10.312 cm), Width: 8.540" (21.691 cm) (standard case with feet and no handle)
Weight:	<6.6 lb (<3 kg) excluding optional battery
Accessories Furnished:	Operation and Programming Manual Sensor Cable: One per input Power cord plug that matches destination requirements.

B-2 System Defaults

The following default parameters are loaded whenever preset is selected from the front panel or through GPIB.

SENSOR - setup

settle % per reading	0.10 %
measurement mode	default
range hold	auto

SENSOR - cal factor

Source	Frequency
source (HP437B & HP438A)	manual
source = frequency	
input signal frequency	50 MHz
source = manual	
cal factor	100 %
cal adjust	100 %
input signal frequency	50 MHz
source = volts/GHz	
start freq	10 MHz
stop freq	20 GHz
start voltage	0 volts
stop voltage	10 volts
units	percent

SENSOR - averaging

SYSTEM - setup = readout or Power vs. Time

Mode	auto
mode (HP437B & HP438A)	auto
mode = moving	
mode = repeat	
averaging number	64
auto low level averaging	low

SYSTEM - setup = profile

System Defaults

graph averaging state	off
between cursor average	on
SENSOR - offset	
offset type	off
offset type (HP437B)	off
offset type (HP438A)	fixed offset type = fixed
offset value	0 dB
offset type = table	
table number	1
frequencies	0 Hz
offset values	0 dB
SENSOR - duty cycle	
duty cycle state	off
duty cycle	100 %
CHANNEL - setup	
input config	chan 1 = A, chan 2 = off
input config (HP437B & HP438A)	chan 1 = A, chan 2 = off
meas units	dBm
meas units (HP437B)	dBm
meas units (HP438A)	watts
display resolution	2 decimal places
tracking min/max display	off
CHANNEL – relative	off
CHANNEL - limits	
high limit	0 dBm
high limit (HP437B)	90 dBm
high limit (HP438A)	0 dBm
low limit 0 dBm	
low limit (HP437B)	-90 dBm
low limit (HP438A)	0 dBm

high limit enabled	off
low limit enabled	off
fail indicator hold	off
fail beep control	off

TRIGGER

SYSTEM - setup = readout or Power vs. Time

SENSOR - meas mode = default	std trigger mode
------------------------------	------------------

SENSOR - meas mode = mod average	std trigger mode
----------------------------------	------------------

SENSOR - meas mode = custom	
-----------------------------	--

TRIGGER - setup

source	continuous
--------	------------

sample delay	1 ms
--------------	------

sample gate width	20 ms
-------------------	-------

source = continuous, manual

trigger arming	blanking off
----------------	--------------

source = internal A, internal B

trigger arming	blanking off
----------------	--------------

trigger type	rise
--------------	------

trigger level	> -15 dBm
---------------	-----------

source = external TTL

trigger edge	rise
--------------	------

SYSTEM - setup = profile

TRIGGER - setup

source	continuous
--------	------------

sample delay	1 ms
--------------	------

sample gate width	20 ms
-------------------	-------

source = continuous, manual

trigger arming	blanking off
----------------	--------------

source = internal A, internal B

trigger arming	blanking off
----------------	--------------

scale top dB value	20 dB
scale bottom dB value	-50 dB
readout	on
link cursor	off
hold	off

SYSTEM - display

battery backlight	on
display contrast	5
peak meter display	off
frequency/offset display	off
GPIB user text display	off
backlight = timed	
time	5 min

SYSTEM - sound

key click state	off
edit error beep	off
limits fail beep channel 1	off
limits fail beep channel 2	off
cursor off screen beep	off

SYSTEM - battery (if present)

auto power off	enable
auto power off time	30 min

SYSTEM - rear panel - GPIB

GPIB address	13 (factory preset only)
emulation mode	ML24xx (factory preset only)

SYSTEM - rear panel - RS232

mode	EXT COMMS
baud rate	9600 (factory preset only)
modem	redial count 5 delay 5 minutes

System Defaults

auto limits false
range false
power false

SYSTEM - rear panel - BNC

output 1 & 2

mode off

mode = analog out

channel 1

start volts 0 V

stop volts 5 V

start display value -10 dB

stop display value 0 dB

mode = pass/fail

channel 1

pass level high

output 1 only

mode = AC MOD output

output off

polarity positive

output 2 only

mode = RF blanking

channel 1

output TTL during zero high

input 1

blanking active TTL level high

SYSTEM - rear panel - printer

printer type HP Deskjet 340 (factory preset only)

SYSTEM - graphics

connect graph points on

tracking min max single sweep

graph ref line	off
pre-trigger percentage	10 %
SYSTEM - secure	
secure state	off
CAL/ZERO	
RF calibrator	off

B-3 System Error Messages

This section details some of the front panel error messages that may appear. In most cases, the error condition can be easily corrected. If not, note the error message and contact the nearest Anritsu Service Center. Errors shown here with xxxx in the display contain a numeric error code.

Table B-1. Error Messages

Error Message	Meaning
SAVE RECALL STORE 0	Attempting save to or recall from current store, i.e., 0.
RECALL EMPTY STORE	Attempted to recall empty store.
SAVE RECALL STORE NUMBER	Illegal store number. NOTE: Save Recall error messages will only be seen under the following two conditions: 1. While doing a save or recall over the GPIB with the measurement display active on the front panel. 2. While doing a save or recall from the front panel and quickly exiting to a measurement display when an error is reported.
SENSOR x over range / under range	Range Hold is selected for Sensor x, but the measured value is too large or small for the range selected.
CHAN x display range	Channel x display value is greater than +99.999 dBm or less than -99.999 dBm.
CHAN x illegal LOG calc	Combination of sensor values results in an illegal calculation.
SENSOR x CAL error (xxxx)	Sensor x Cal 0 failed, xxxx = error code
SENSOR x CAL 0 dBm invalid	Sensor x Cal 0 dBm failed.
SENSOR x ZERO . . .	ZERO in progress
SENSOR x ZERO error (xxxx)	ZERO failed xxxx = 4 digit code
SENSOR x not fitted	Sensor x is required for the current measurement, but is not fitted.
Printer buffer full	Try selecting print, when current job finished.
Chan x - NO trigger	Waiting for trigger on specified channel for more than 6 seconds
Increase PERIOD to > 6 ms	WARNING: In profile mode, when using manual or continuous trigger, the data collection period must be > 6 ms.
Updating SENSOR data	Programming SENSOR EEPROM
Graph Channel Off	In any graph mode, the selected display channel is off.

Table B-1. Error Messages

Error Message	Meaning
Put sensor number limit	Attempt to read/write sensor B setup on ML2437A
Sensor x cal factor error	Cal factor out of range - sensor x
PUT current mode limit	Present configuration will not allow requested change.
Internal error (P6)	Entered numeric value out of range
Internal error (P10)	Requested action NOT allowed
Internal error (P20)	Cal factor edit - duplicate frequency entered
Internal error (P21)	Cannot delete last cal factor data pair in selected table, or cannot add cal factor data pair in selected table
Internal error (P22)	Cannot delete 50 MHz cal factor in selected table
Internal error (P23)	Non valid cal factor table

B-4 Calibration and Zero Error Codes

Table B-2. Error Messages

Error Message	Meaning
DDx	DC_Null failure
DDxD, x=odd number	DC-range 2 gain failure
DDxD, x=4-7,C-F	AC_Null failure
DDxD, x=8-F	Reference voltage range calibration failure
DxDD, x=odd number	Range 4 failed to saturate during calibration
DxDD, x=non zero	Residual Zero too high (+ve) on ranges 3-5
XDDD, x=non zero	Residual Zero too high (-ve) 0n ranges 3-5

Appendix C — GPIB Quick Reference

This appendix contains quick reference tables for all supported commands. Native mode commands are sorted by functional group.

C-1 ML24XXA Quick Reference

The following tables reference ML24XXA (native) mode commands. A command followed by a (?) indicates that there is an equivalent query command for that function.

BNC Functional Group Commands

Table C-1. Functional Group Commands

Command	Function
IBBLP	Blanking active TTL level
OBACM(?)	AC modulation output polarity
OBCH(?)	BNC output port channel configuration
OBDSP(?)	BNC analog output display stop value
OB DST(?)	BNC analog output display start value
OBMD(?)	BNC output mode select
OBPL(?)	BNC pass/fail pass level
OBVSP(?)	BNC analog output stop voltage scale
OBVST(?)	BNC analog output start voltage scale
OBZL(?)	BNC RF blanking output level

Calibration Functional Group Commands

Table C-2. Calibration Functional Group Commands

Command	Function
CAL	Calibrate the selected sensor to 0 dBm
RFCAL(?)	Turn RF reference calibrator ON or OFF
VZERO	Zero the BNC input connector
ZERO	Zero the sensor

Channel Functional Group Commands

Table C-3. Channel Functional Group Commands

Command	Function
CHCFG(?)	Channel input configuration
CHRES(?)	Set channel decimal point resolution

Table C-3. Channel Functional Group Commands

Command	Function
CHUNIT(?)	Set Channel units
FHOLD(?)	Fail indicators Hold
HLIM(?)	Set High limits
HLIMS(?)	Turn on/off High limits
HOLD(?)	Graph hold
LLIM(?)	Set Low limits
LLIMS(?)	Turn on/off Low limits
MMRST	Minimum and maximum Tracking reset
MNMXS(?)	Track minimum and maximum values
REL(?)	Relative control

Data Output Functional Group Commands

Table C-4. Output Functional Group Commands

Command	Function
ERRLST	Returns the DDE error list
GMNMX	Return Graph minimum and maximum values
GRDRQ	Return Graph Data readout
MNGDB	Output Min Graph Binary Data
MNGD	Output Min Graph Data
MXGDB	Output Max Graph Binary Data
MXGD	Output Max Graph Data
O	Return display channel reading
OGBD	Output Graph binary data
OGD	Output Graph data
ON	Output number of channel readings
STATUS	Replies with the power meter's current state code
STERR	Returns the results of the POST or *TST? command
SYSLD	Sets the store number for the saved setup
SYSRD	Output the saved setup over the GPIB

Display Functional Group Commands

Table C-5. Display Functional Group Commands

Command	Function
DCONT(?)	Set display Contrast
DCONTD	Set display contrast down by one
DCONTU	Set display contrast up by one
DISP(?)	Display ON or OFF
DPEAK(?)	Peak meter display

GPIB 488.2 Functional Group Commands

Table C-6. GPIB 488.2 Functional Group Commands

Command	Function
*CLS	Clear GPIB status bytes
*ESE	Event Status Byte enable
*ESE?	Return Event status register enable mask
*ESR?	Event status register request
*IDN?	Request device identification
*OPC	Operations complete
*OPC?	Operations complete Output '1'
*RST	Reset device
*SRE	Setup service request enable register
*SRE?	Return Service Request enable register
*STB?	Return status byte register
*TRG	Perform a trigger 'GET' command
*TST?	Self Test
OI	Request device identification

GPIB Setup Functional Group Commands

Table C-7. GPIB Setup Functional Group Commands

Command	Function
ADDR(?)	Change GPIB address
CONT	Continue
EMUL	GPIB emulation mode
FAST(?)	Operate in non-488.2 compliant mode
START	Initial startup self test command

GPIO Trigger Functional Group Commands

Table C-8. GPIO Trigger Functional Group Commands

Command	Function
GT0	Set to ignore GET command
GT1	Set 'GET' command to TR1 type trigger
GT2	Set 'GET' command to TR2 type trigger
TR0	Trigger hold mode
TR1	Trigger immediate
TR2	Trigger with a settling delay
TR3	Trigger free run

Profile Setup Functional Group Commands

Table C-9. Profile Setup Functional Group Commands

Command	Function
CURLK(?)	Link cursors in profile mode
DTRGD(?)	Display Trigger Delay
GRAVG(?)	Average between profile cursors
GPRST	Reset min/max graph
GRCP(?)	Connect points on profile
GRDATA(?)	Display Graph Data
GRFS(?)	Profile Reference line state
GRMD(?)	Profile and Power vs. Time Mode Channel Selection
GRPIX(?)	Profile type
GRPRD(?)	Profile data collection period
GRPTP(?)	Graph Pre-trigger Percentage
GRSWP(?)	Sweep to Sweep averaging
GRSWR	Reset Profile Sweep to Sweep Averaging
GRTMM(?)	Profile Min/Max tracking mode
GRYB(?)	Set profile Y-axis bottom scale
GRYT(?)	Set profile Y-axis top scale

Sensor Functional Group Commands

Table C-10. Sensor Functional Group Commands

Command	Function
AVG(?)	Sets the averaging type for the sensor
AVGLL(?)	Auto low level averaging
AVGM	Manual Averaging
CFADJ(?)	Cal Adjust
CFCAL(?)	Cal factor manual setting
CFFRQ(?)	Cal Factor Frequency value
CFSRC(?)	Cal Factor Source
CFUADD	Add an entry pair to a cal factor table
CFUCT	Clear cal factor table
CFUID(?)	Cal factor table identity
CFULD	Cal factor table binary load
CFUPT	Preset cal factor table
CFURD	Cal factor table binary read
CFUSAV	Cal factor table save
CFUSEL	Cal factor table select
CFUTBL	Cal factor tables
CFUUSE	Cal factor tables used
CFUVLD	Valid table check
CFVAL	Current cal factor value
CVSPF(?)	VGHz cal factor stop frequency
CVSPV(?)	VGHz cal factor stop voltage
CVSTF(?)	VGHz cal factor start frequency
CVSTV(?)	VGHz cal factor start voltage
DUTY(?)	Duty cycle
DUTYS(?)	Duty cycle state
OFFCLR	Clear an offset table
OFFFIX(?)	Offset fixed value
OFFTBL(?)	Select an offset table
OFFTBR	Output an offset table
OFFTBU	Update an offset table
OFFTYP(?)	Offset type to use
OFFVAL	Sensor Offset Value
RGH(?)	Range Hold Sensor
SENNM(?)	Sensor Measurement mode

Table C-10. Sensor Functional Group Commands

Command	Function
SENMO(?)	Universal Sensor operation mode
SENSTL(?)	Set Sensor Settle Percentage
SENTYP	Return sensor information

System Functional Group Commands

Table C-11. System Functional Group Commands

Command	Function
*RCL	Recall a stored setup
*SAV	Save configuration
BAUTS(?)	Battery Auto State
BAUTT(?)	Battery Auto shut off after x minutes
BUFF	GPIB response buffering enabled
CUR	Cursor movement in Power vs. Time and Source Sweep modes
DBLGHT(?)	Battery LCD Back light mode
DBLTIM(?)	Auto Backlight OFF timer setting
ENTERR(?)	Entry Error beep
FBEEP(?)	Fail Beep On/Off
FROFF(?)	Frequency/Offset display
FRST	Factory Reset
GRAUTO	Auto scaling
GRDDT(?)	Power vs. Time data display time
KEYCK(?)	Turn key click sound on or off
MODDEL	Modem redial delay time
MODINIT	Initialize modem
MODLIM	Autodial enable for limits failure
MODPH	Autodial phone number
MODPWR	Autodial enable for power on
MODRED	Redial count
MODRNG	Autodial enable for range error
OPMD(?)	Operation mode
PRINT	Send details to the connected printer
PRNSEL	Select the type of printer
RSBAUD(?)	Set the RS232 Baud rate
SECURE(?)	Secure system state

Table C-11. System Functional Group Commands

Command	Function
SRCMOD(?)	Source sweep mode
SRCSTRFQ(?)	Source sweep start frequency
SRCSPFRQ(?)	Source sweep stop frequency
SRCSTPWR(?)	Source sweep start power
SRCSPWR(?)	Source sweep stop power
SRCSTAT	Source sweep status request
SYSLNM	Saved set naming
TEXT(?)	User text command
TEXTS(?)	User text display command

Trigger Functional Group Commands

Table C-12. Trigger Functional Group Commands

Command	Function
GTARM(?)	Set profile trigger arming
GTDLY(?)	Set profile trigger sample delay
GTGW(?)	Set profile trigger gate width
GTLVL(?)	Set profile trigger level
GTSRC(?)	Set profile Trigger source
GTTYP(?)	Set profile trigger type
GTXTTL(?)	Set profile external trigger edge
LINK(?)	Link graph and readout trigger
TRGARM(?)	Trigger arming
TRGDLY(?)	Trigger sample delay
TRGGW(?)	Set trigger gate width
TRGLVL(?)	Set trigger level
TRGMODE	Change trigger mode
TRGSRC(?)	Set trigger source
TRGTYP(?)	Set Trigger type
TRGXTTL(?)	Set external trigger edge type

ML24XXA Native Mode Query Commands

Table C-13. ML24xxA Native Mode Query Commands

Query	Return String
ADDR?	ADDR <VAL>
AVG? <S>	AVG <S>,<MODE>,<VAL>
AVGLL? <S>	AVGLL <S>,<MODE>
BAUTS?	BAUTS <STATE>
BAUTT?	BAUTT <VAL>
CFADJ? <S>	CFADJ <S>,<UNITS>,<VAL>
CFCAL? <S>	CFCAL <S>,<UNITS>,<VAL>
CFFRQ? <S>	CFFRQ <S>,<VALUE>
CFSRC? <S>	CFSRC <S>,<SOURCE>
CFUID? <S>,<TABLE NO>	CFUID <S>,<TABLE NO>,<IDENTITY>
CFUNITS? <S>	CFUNITS <S>,<UNITS>
CHCFG? <C>	CHCFG <C>,<CONFIG>
CHRES? <C>	CHRES <C>,<VAL>
CHUNIT? <C>	CHUNIT <C>,<UNITS>
CURLK?	CURLK <STATE>
CVSPF? <S>	CVSPF <S>,<VAL>
CVSPV? <S>	CVSPV <S>,<VAL>
CVSTF? <S>	CVSTF <S>,<VAL>
CVSTV? <S>	CVSTV <S>,<VAL>
DBLGHT?	DBLGHT <MODE>
DBLTIM?	DBLTIM <VAL>
DCONT?	DCONT <VAL>
DISP?	DISP <STATE>
DPEAK?	DPEAK <MODE>
DTRGD?	DTRGD <VAL>
DUTY? <S>	DUTY <S>,<DUTY CYCLE>
DUTYS? <S>	DUTYS <S>,<STATE>
ENTERR?	ENTERR <STATE>
FBEEP? <C>	FBEEP <C>,<STATE>
FHOLD? <C>	FHOLD <C>,<STATE>
FROFF?	FROFF <STATE>
GRAVG?	GRAVG <STATE>
GRCP?	GRCP <STATE>
GRDATA?	GRDATA <STATE>

Table C-13. ML24xxA Native Mode Query Commands

Query	Return String
GRDDT?	GRDDT <TIME>,<UNITS>
GRFS?	GRFS <STATE>
GRMD?	GRMD <C>
GRPIX?	GRPIX <MODE> (MODE can be AVG in Power vs. Time mode)
GRPTP?	GRPTP <VAL>
GRPRD?	GRPRD <VAL>
GRSWP? <S>	GRSWP <S>,<VAL>
GRSWS?	GRSWS <STATE>
GRTMM?	GRTMM <MODE>
GRYB?	GRYB <VAL>
GRYT?	GRYT <VAL>
GTARM?	GTARM <STATE>
GTDLY?	GTDLY <VAL>
GTGW?	GTGW <VAL>
GTLVL?	GTLVL <VAL>
GTSRC?	GTSRC <SOURCE>
GTTYP?	GTTYP <TYPE>
GTXTTL?	GTXTTL <TYPE>
HLIM? <C>	HLIM <C>,<VAL>
HLIMS? <C>	HLIMS <C>,<STATE>
HOLD?	HOLD <STATE>
IBBLP?	IBBLP <polarity>
KEYCK?	KEYCK <STATE>
LINK?	LINK <STATE>
LLIM? <C>	LLIM <C>,<VAL>
LLIMS? <C>	LLIMS <C>,<STATE>
MNMXS? <C>	MNMXS <C>,<STATE>
MODDEL?	MODDEL <value>
MODLIM?	MODLIM <>true> or <>false>
MODPH?	MODPH <phone_number>
MODPWR?	MODPWR <>true> or <>false>
MODRED?	MODRED <count>
MODRNG?	MODRNG <>true> or <>false>
OBACM?	OBACM <POLARITY>
OBCH? <PORT>	OBCH <PORT>,<C>

Table C-13. ML24xxA Native Mode Query Commands

Query	Return String
OBDSP? <PORT>	OBDSP <PORT>,<UNITS>,<VAL>
OB DST? <PORT>	OB DST <PORT>,<UNITS>,<VAL>
OBMD? <PORT>	OBMD <PORT>,<MODE>
OBPL? <PORT>	OBPL <PORT>,<LEVEL>
OBVSP? <PORT>	OBVSP <PORT>,<VAL>
OBVST? <PORT>	OBVST <PORT>,<VAL>
OBZL?	OBZL <LEVEL>
OFFFIX? <S>	OFFFIX <S>,<VAL>
OFFTBL? <S>	OFFTBL <S>,<VAL>
OFFTYP? <S>	OFFTYP <S>,<TYPE>
OPMD?	OPMD <MODE>
PRNSEL?	PRNSEL <printer>
REL? <C>	REL <C>,<MODE>
RFCAL?	RFCAL <STATE>
RGH? <S>	RGH <S>,<VAL>
RSBAUD?	RSBAUD <VAL>
RSMODE?	RSMODE <state>
SECURE?	SECURE <STATE>
SENMM? <S>	SENMM <S>,<MODE>
SENMO?	SENMO <S>,<VAL>
SENSTL? <S>	SENSTL <S>,<MODE>
SRCMOD?	SRCMOD <MODE>
SRCSPFRQ?	SRCSPFRQ <FREQ>
SRCSTFRQ?	SRCSTFRQ <FREQ>
SRCSPWR?	SRCSPWR <POWER>
SRCSTPWR?	SRCSTPWR <POWER>
SYSLNM? <STORE NO>	SYSLNM <STORE NO>,<STORE NAME>
TEXT?	TEXT <TEXT STRING>
TEXTS?	TEXTS <STATE>
TRGARM? <C>*	TRGARM <C>,<STATE>
TRGDLY? <C>*	TRGDLY <C>,<VAL>
TRGGW? <C>*	TRGGW <C>,<VAL>
TRGLVL? <C>*	TRGLVL <C>,<VAL>
TRGMODE?	TRGMODE<MODE>
TRGSRC?<C>*	TRGSRC <C>,<SOURCE>

Table C-13. ML24xxA Native Mode Query Commands

Query	Return String
TRGTYP? <C>*	TRGTYP <C>,<TYPE>
TRGXTTL? <C>*	TRGXTTL <C>,<TYPE>

C-2 ML4803A Quick Reference

The following tables reference ML4803A emulation mode commands.

ML4803A Emulation Mode Commands

Table C-14. ML4803A Emulation Mode Commands

Command	Function
AVE	Sensor averaging setting
CAL	Set the user cal factor value
CCA	Clear the user cal factor to zero
CDJ	Perform a Cal 0 dBm
COF	Clear the offset value to zero
COS	Turn ON the 50 MHz, 0 dBm RF calibrator output
CRF	Clear the reference value to zero
CST	Turn OFF the 50 MHz, 0 dBm RF calibrator output
DBM	Sets the display channel units to dBm
DBR	Set the display channel units to dB and takes the relative value
EMUL	GPIB emulation mode
MCA	Set the cal factor value at the specified memory location in dBm
MCC	Clears the cal factor value at the specified memory location
MCO	Clears the offset value at the specified memory location
MCQ	Clears the frequency value at the specified memory location
MCR	Clears the reference value at the specified memory location
MCT	Clears all values at the specified memory location
MDI	Disable memory store setting and use
MEN	Enable setting of the memory stores and apply the last memory store configured
MFG	Set the frequency value at the specified memory location in GHz
MFM	Set the frequency value at the specified memory location in MHz

Table C-14. ML4803A Emulation Mode Commands

Command	Function
MOF	Set the offset value at the specified memory location in dBm
MRF	Set the reference value at the specified memory location in dBm
ODT	Output the current calibration factor, offset value, and reference level
OFF	Set sensor offset value
OI?	Request identity
OMR	Output a memory store set of data
OPW	Request for channel reading
REF	Set the reference value
RNG	Sensor measurement range hold
SRQ	Turns on or off the SRQ on output data ready
STA	Restart averaging reading
WAT	Set the display channel unit to Watts
ZAJ	Zero the sensor

C-3 HP436A Quick Reference

The following table references HP436A emulation mode commands.

HP436A Emulation Mode Commands

Table C-15. HP436A Emulation Mode Commands

Command	Function
+	Disable cal factors
-	Enable cal factors
1, 2, 3, 4 & 5	Set sensor operating range
9	Auto range
A	Watt
B	dB (rel)
C	dB (ref)
D	dBm
EMUL	Select emulation mode
H	Hold mode
I	Trigger without settling
OI	Identification
R	Free run mode
T	Trigger with settling
V	Free run mode with settling
Z	Zero sensor

C-4 HP437B Quick Reference

The following table references HP437B emulation mode commands.

HP437B Emulation Commands

Table C-16. HP437B Emulation Mode Commands

Command	Function
+	Disable cal factors
-	Enable cal factors
1, 2, 3, 4 & 5	Set sensor operating range
9	Auto range
A	Watt
B	dB (rel)
C	dB (ref)
D	dBm
EMUL	Select emulation mode
H	Hold mode
I	Trigger without settling
OI	Identification
R	Free run mode
T	Trigger with settling
V	Free run mode with settling
Z	Zero sensor

C-5 HP438A Quick Reference

The following table references HP438A emulation mode commands.

HP438A Emulation Commands

Table C-17. HP438A Emulation Mode Commands

Command	Function
?ID	Return ID string
@1	Set SRE mask
AD	Config to A-B
AP	Config to A
AR	Set display A / B
BD	Set display B – A
BP	Set single sensor B display
BR	Set display B / A
CL	Cal Adjust
CS	Clear all status bytes
DA	Display All
DD	Display disable
DE	Display enable
DR	Set GPIB address
EMUL	GPIB emulation mode
FA	Auto average
FH	Average hold
FM	Set average value
GT	Set group trigger
KB	Calibration factor
LG	Set log units
LH	Set high limit
LL	Set low limit
LM	Limits check state
LN	Set linear units
OC	Set calibrator state
OI	Identification
OS	Set offset value
PR	Preset the unit
RA	Auto Range
RC	Recall setup

Table C-17. HP438A Emulation Mode Commands

Command	Function
RH	Range hold
RL	Relative mode
RM	Range hold set
RV	Read service request mask value.
SM	Status message
ST	Store setup
TR0	Trigger hold mode
TR1	Trigger immediate
TR2	Trigger with a settling delay
TR3	Trigger free run
ZE	Zero sensors

C-6 HP-IB Support

The following tables list HP-IB commands for the HP437B and HP438A power meters, and which commands are supported in the Anritsu ML243xA power meter. Restrictions, if any, are also listed. Commands that are not supported will be ignored.

HP437B Commands

Table C-18. HP437B Emulation Mode Commands

Mnemonic	Action	Supported?	Restrictions
CL	CAL 0 dBm	Yes	None
*CLS	Clear Status	Yes	None
CS	Clear status	Yes	None
CT0-CT9	Sensor data tables	Yes	None
DA	Set all screen pixels	Yes	None
DC0	Duty cycle OFF	Yes	None
DC1	Duty cycle ON	Yes	None
DD	Disable display	Yes	DISP OFF restrictions: Screen and min/max not updated, Relative not active
DE	Display enable	Yes	DISP ON. None.
DF	Disable Display	Yes	see DD
DN	Down arrow	No	Not supported
DU	User message	No	Not supported
DY	Duty cycle	Yes	None
EN	Enter msg terminator	Yes	None
ERR?	Error query	No	Not supported
*ESR?	Read event reg	Yes	None
*ESE	Set event enable reg	Yes	None
*ESE?	Read event enable reg	Yes	None
ET0-ET9	Edit cal factor table	Yes	None
EX	Exit	Yes	None
FA	Auto average	Yes	None
FH	Average hold	Yes	None
FM	Manual average	Yes	None
FR	Set frequency	Yes	Switch to frequency cal factor source.
GT0	Ignore GET	Yes	None
GT1	TR1 on GET	Yes	None

Table C-18. HP437B Emulation Mode Commands

Mnemonic	Action	Supported?	Restrictions
GT2	TR2 on GET	Yes	None
GZ	Terminator	Yes	None
HZ	Terminator	Yes	None
ID	Return ID string	Yes	None
IDN?	Return ID string	Yes	None
KB	Set cal factor	Yes	None
KZ	Terminator	Yes	None
LG	Units to dBm	Yes	None
LH	Set high limit	Yes	On channel not sensor.
LL	Set low limit	Yes	On channel not sensor
LM0	Limit check off	Yes	Both high and low off as HP437B
LM1	Limit check on	Yes	Both high and low on as HP437B
LN	Units to Watts	Yes	None
LP	Learn mode 1	No	Not supported
LT	Left arrow	No	Not supported
MZ	Terminator	Yes	None
OC0	RF calibrator off	Yes	None
OC1	RF calibrator on	Yes	None
OD	Output display text	Yes	Supports reading output and Cal factor table output only. (F=Factory table.)
OF0	Offset off	Yes	None
OF1	Offset on	Yes	None
OS	Set offset value	Yes	OSDOEN not supported
PCT	Terminator	Yes	None
PR	Preset	Yes	None
RA	Auto range	Yes	None
RC	Recall setup	Yes	Limited to 10 stores
RE	Resolution	Yes	Set screen decimal places
RF0-RF9	Sensor cal factors	Yes	None
RH	Range hold	Yes	None

Table C-18. HP437B Emulation Mode Commands

Mnemonic	Action	Supported?	Restrictions
RL0	Relative mode off	Yes	None
RL1	New relative value	Yes	None
RL2	Use old relative value	Yes	None
RM	Set sensor range	Yes	ML243xA ranges
*RST	Reset	Yes	None
RT	Right arrow	No	Not supported
RV	Read SRE	Yes	None
SE	Select data table	Yes	None
SM	Status output	Yes	As much as has meaning for ML243xA. Set to 0 if not used
SN0-SN9	Serial number	Yes	None
SP	Special	No	Not supported
*SRE	Set SRQ enables	Yes	None
*SRE?	Read SRQ enables	Yes	None
ST	Store setup	Yes	Limited to 10 stores
*STB?	Read status byte	Yes	None
TR0	GPIB trigger hold	Yes	None
TR1	Immediate trigger	Yes	None
TR2	Settled trigger	Yes	None
TR3	Trigger hold off	Yes	None
*TST?	Selftest	Yes	Always returns 0
UP	Up arrow	No	Not supported
@1	Status mask	Yes	None
@2	Learn mode 2	No	Not supported
%	Terminator	Yes	None

HP438A Commands

Table C-19. HP438A Commands

Mnemonic	Action	Supported?	Restrictions
AD	Config to A-B	Yes	None
AE	Select sensor A	Yes	None
AP	Config to A	Yes	None
AR	Config A/B	Yes	None
BD	Config to B-A	Yes	None
BE	Select sensor B	Yes	None
BP	Config to B	Yes	None
BR	Config to B/A	Yes	None
CL	CAL 0 dBm	Yes	None
CS	Clear status	Yes	None
DA	Set all screen pixels	Yes	None
DD	Disable display	Yes	DISP OFF restrictions: Screen and min/max not updated, Relative not active.
DE	Display enable	Yes	DISP ON. None.
DO	Display to offset	No	Not supported
EN	Enter msg terminator	Yes	None
FA	Auto average	Yes	None
FH	Average hold	Yes	None
FM	Manual average	Yes	None
GT0	Ignore GET	Yes	None
GT1	TR1 on GET	Yes	None
GT2	TR2 on GET	Yes	None
KB	Set cal factor	Yes	None
LG	Units to dBm	Yes	None
LH	Set high limit	Yes	On channel not sensor.
LL	Set low limit	Yes	On channel not sensor
LM0	Limit check off	Yes	Both high and low off as HP437B
LM1	Limit check on	Yes	Both high and low on as HP437B
LN	Units to Watts	Yes	None
LP1	Learn mode1	No	Not supported

Table C-19. HP438A Commands

Mnemonic	Action	Supported?	Restrictions
LP2	Learn mode2	No	Not supported
OC0	RF calibrator off	Yes	None
OC1	RF calibrator on	Yes	None
OS	Set offset value	Yes	OSDOEN not supported
PR	Preset	Yes	None
RA	Auto range	Yes	None
RC	Recall setup	Yes	Limited to 10 stores
RH	Range hold	Yes	None
RL0	Relative mode off	Yes	None
RL1	New relative value	Yes	None
RM	Set sensor range	Yes	ML243xA ranges
RV	Read SRE	Yes	None
SM	Status output	Yes	As much as has meaning for ML243xA. Set to 0 if not used
ST	Store setup	Yes	Limited to 10 stores
TR0	GPIB trigger hold	Yes	None
TR1	Immediate trigger	Yes	None
TR2	Settled trigger	Yes	None
TR3	Trigger hold off	Yes	None
@1	Status mask	Yes	None
?ID	Return ID string	Yes	None

Note

The Factory cal factor table can be read by sending an 'F' instead of the table number. The HP438 emulation mode supports the HP437 cal factor table commands on the ML243xA. This allows the cal factor tables to updated or read since the ML243xA supports cal factor tables.

Appendix D — Connector Care and Handling

Follow the precautions listed below when handling or connecting cables. Complying with these precautions will guarantee longer component life and less equipment down time due to connector or device failure.

D-1 Pin Depth Mating Connectors

Destructive pin depth of mating connectors is the major cause of failure in the field. When an RF component is mated with a connector having a destructive pin depth, damage will usually occur to the RF component connector. A destructive pin depth is one that is too long in respect to the reference plane of the connector (see figure below).

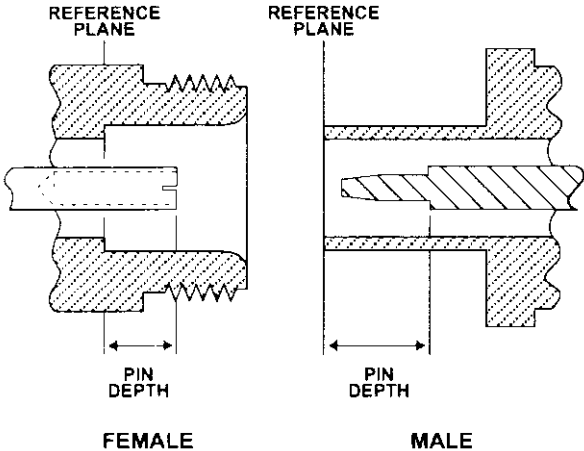

Figure D-1. N Connector Pin Depth Definition

Torquing Connectors

The center pin of a precision RF component connector has a precision tolerance. The mating connectors of various RF components may not be precision types. Consequently, the center pins of these devices may not have the proper pin depth. The pin depth of EUT connectors should be measured to assure compatibility before attempting to mate them with Power Sensor connectors. An Anritsu Pin Depth Gauge or equivalent can be used for this purpose.

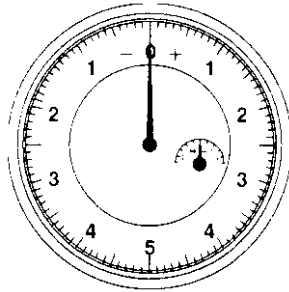

Figure D-2. Pin Depth Gauge

If the measured connector is out of tolerance in the "+" region, the center pin is too long (see Allowable EUT connector pin depth table below). Mating under this condition will likely damage the precision RF component connector. If the test device connector measures out of tolerance in the "-" region, the center pin is too short. This should not cause damage, but it will result in a poor connection and a consequent degradation in performance.

EUT Connector Type	Anritsu Gauging Set Model	Pin Depth (inches)	Pin Depth Gauge Reading
N - Male	01-163	207 -0.000	207 +0.000
N - Female		+0.030	-0.030
WSMA - Male	01-162	-0.000	Same as pin depth
WSMA - Female		-0.010	
3.5 mm - Female			

D-2 Torquing Connectors

Over torquing connectors is destructive; it may damage the connector center pin. Finger-tight is usually sufficient for Type N connectors. Always use a connector torque wrench (8 lbf-in) when tightening WSMA, K or V type connectors. Never use pliers to tighten connectors.

D-3 Mechanical Shock

Precision connectors are designed to withstand years of normal bench handling. However, do not drop or otherwise treat them roughly. Mechanical shock will significantly reduce their service life.

D-4 Cleaning Connectors

The precise geometry that makes possible the RF component's high performance can easily be disturbed by dirt and other contamination adhering to the connector interfaces. When not in use, keep the connectors covered.

To clean the connector interfaces, use a clean cotton swab that has been dampened with isopropyl alcohol.

Note

Most cotton swabs are too large to fit in the smaller connector types. In these cases, it is necessary to peel off most of the cotton and then twist the remaining cotton tight. Be sure that the remaining cotton does not get stuck in the connector. Cotton swabs of the appropriate size can be purchased through a medical laboratory-type supply center.

The following are some important tips on cleaning connectors:

- Use only isopropyl alcohol as a cleaning solvent.
- Do not use excessive amounts of alcohol as prolonged drying of the connector may be required.
- Never put lateral pressure on the center pin of the connector.
- If installed, do not disturb the Teflon washer on the center conductor pin.
- Verify that no cotton or other foreign material remains in the connector after cleaning.
- If available, use compressed air to remove foreign particles and to dry the connector.
- After cleaning, verify that the center pin has not been bent or damaged.

Index

- Numerics**
- 488.1 8-5
 488.2 8-6
 command format 8-6
- A**
- accessories 1-1, 1-2
 advanced triggering 6-14
- B**
- battery 2-2
 changing 2-3
 removing 2-3
 replacing 2-3
- C**
- channel menu 5-13
 channels
 using both 7-11
 connections 4-1
 connector care D-1
 CW power measurements 7-1
- D**
- data I/O formats 8-1
 default settings B-3
- E**
- environmental requirements 2-2
 error codes B-12
 error messages B-10
- F**
- front panel connectors 4-1
 front panel controls 5-2
- G**
- gain compression measurement 7-15
 GPIB 6-3
 quick reference C-1
 GPIB PC card 8-4
 grounding 2-2
 GSM-TDMA bursts 7-23
- I**
- identification number 1-1
 inspection 2-1
 instrument shipment 2-5
 instrument storage 2-5
- M**
- manual
 associated documents 1-1
 scope of 1-1
 memory types 3-1
 model types 1-1
 modulated carrier 7-8
- N**
- non-volatile RAM 3-2
- O**
- optimising measurements 7-9
 options 1-1, 1-2
- P**
- power measurement 6-1
 power requirements 2-1
 power versus time 7-27
 power-on 5-3
 printer connections 6-3
 profile operation mode 6-10
 programming examples 8-132
 pulse signals 7-17, 7-19
- Q**
- query commands 8-4
- R**
- rack mounting 2-3
 rear panel connectors 4-2
 remote commands 8-11
 remote operation 6-3
 remote reference C-1
 RS232 modem 6-5
- S**
- Safety Symbols
 For Safety 1-2
 In Manuals 1-1
 On Equipment 1-1
 sensor
 calibration 6-2
 handling 2-1
 types 1-1
 zero/cal 6-2
 zeroing 6-1
 sensor menu 5-5

T to Z

sensors	1-2
using two	7-13
serial remote	6-4
shipment	2-5
software	1-1
software loading	6-24
source sweep mode	6-15
specification	B-1
storage	2-5
support	A-1
system defaults	B-3
system menu	5-22

T

technical support	A-1
trigger menu	5-16
triggered measurements	6-12
triggering	6-14

U

user cal factors	6-17
------------------------	------

Z

zeroing sensors	6-1
-----------------------	-----

Anritsu



Anritsu utilizes recycled paper and environmentally conscious inks and toner.

Anritsu Company
490 Jarvis Drive
Morgan Hill, CA 95037-2809
USA
<http://www.anritsu.com>