

**Anritsu** Advancing beyond

# VectorStar™ Series

Family of RF to Microwave and Millimeter-Wave Vector Network Analyzers with Industry-Leading Performance from 70 kHz to 1.1 THz

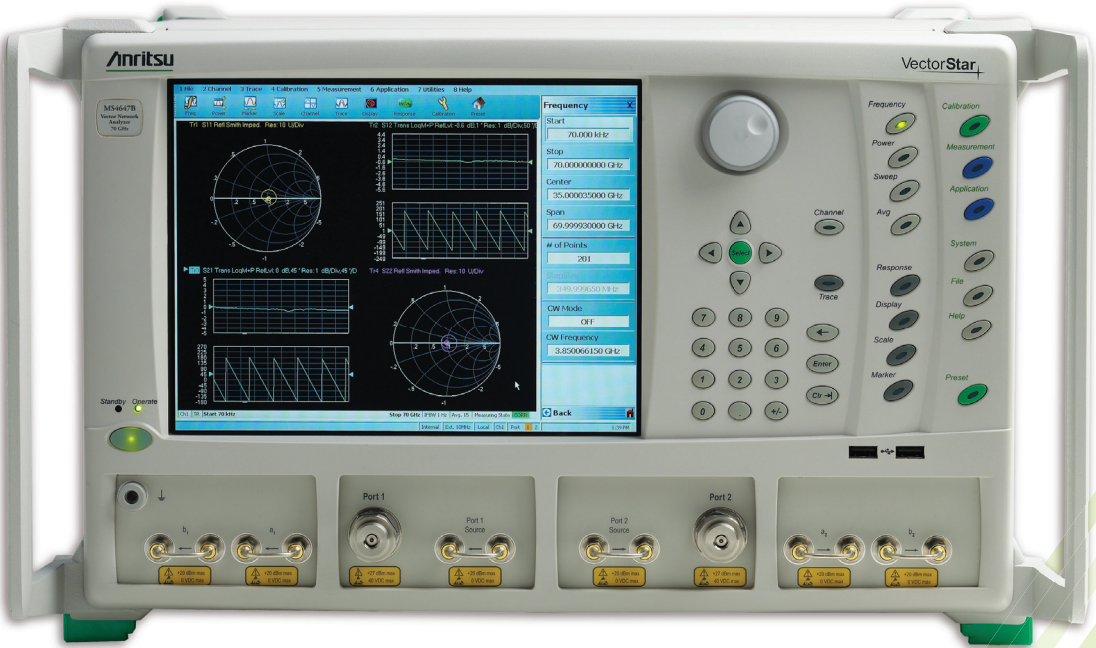

### Introduction

#### Industry-Leading, Single-Sweep Frequency Span from 70 kHz to 220 GHz

Building on design experience of more than 40 years, Anritsu has now broken the RF barrier with the VectorStar MS4640B Series — spanning from 70 kHz to 70 GHz in a single connector and 70 kHz up to 220 GHz in the broadband configuration (with options to 1.1 THz using millimeter-wave (mmWave) modules).

The VectorStar series offers a new performance benchmark for S-parameter measurements of RF, microwave, and mmWave devices. Anritsu now provides RF and microwave engineers access to a powerful measurement tool for performance analysis of devices ranging from transistors in an on-wafer environment to communication systems in commercial or defense applications.

In addition to maintaining a peak level of measurement performance, each model can be upgraded to a broader frequency range, higher port count, and to include additional options. You can specify the features you need today and add new ones as needed in the future without fear of obsolescence or learning a new test system.

#### VectorStar VNA Features Include:

- Frequency coverage 70 kHz to 20/40/70/110/125/145/220 GHz with extensions to 1.1 THz
- Industry-leading broadband system with world's best dynamic range, accuracy, precision, and stability
- Unique, low-frequency coverage to 70 kHz with up to 100,000 measurement points to achieve the best time domain measurement accuracy
- Superior dynamic range: >140 dB
- Best test port characteristic performance: up to 50 dB directivity, source match, and load match
- High compression point level: up to +15 dBm at 70 GHz
- Upgradable frequency range, port count, and options; start with 2-port 20 GHz configuration and upgrade when needed
- Precision AutoCal™ units available for simple, guided calibrations
- Two independent sources with high output power: up to +14 dBm
- 4-port single-ended, mixed-mode, and true differential mode measurements
- mmWave noise figure measurements
- True mode stimulus analysis from 70 kHz to 20/40/70/110/145/220 GHz with industry-leading accuracy and stability
- PulseView™ with industry-leading 2.5 ns pulse measurement resolution
- Backed by a 3-year warranty

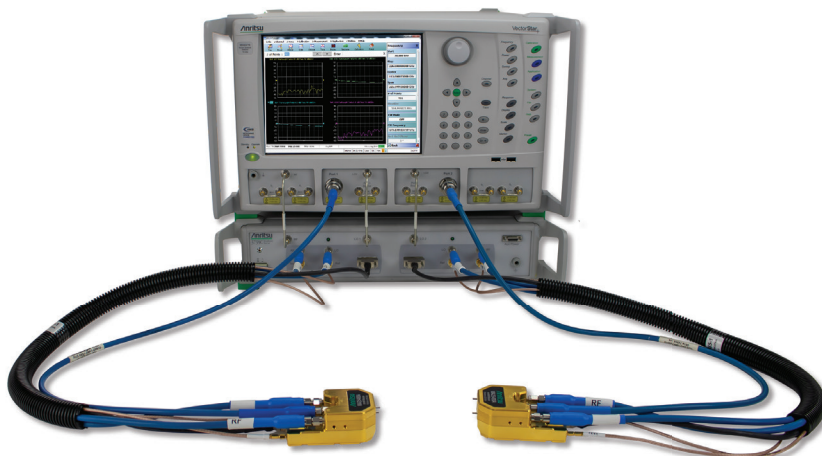

*VectorStar ME7838G System Operates from 70 kHz to 220 GHz through a Single Coaxial Test Port*

## VectorStar™ MS4640B Vector Network Analyzer Series

### Key Features and Benefits

| Key Features   | Benefits   |
|--|--|
| Broadest frequency span from a single coaxial test port, covering 70 kHz to 70 GHz in a single instrument and 70 kHz to 220 GHz in the broadband configuration (with options up to 1.1 THz using mmWave modules) | <ul style="list-style-type: none"> <li>• Obtain the most thorough and accurate broadband device characterization</li> <li>• Eliminate the time-consuming, error-prone concatenation process across the RF, microwave, and mmWave bands</li> <li>• Decrease test instrument expenses</li> <li>• Reduce the risk of DC extrapolation errors in your device modeling</li> </ul>     |
| Superior dynamic range: >140 dB  | <ul style="list-style-type: none"> <li>• Accurately measure medium- and high-loss devices</li> <li>• Catch all potential filter feed-throughs in out-of-band regions</li> <li>• Quickly and easily perform high-sensitivity antenna measurements</li> </ul>  |
| Highest data resolution utilizing 100,000 points for maximum flexibility   | <ul style="list-style-type: none"> <li>• Zoom in on narrowband responses without recalibration</li> <li>• Calibrate the VectorStar system once and have enough data points to test any range</li> </ul>  |
| High available power: up to +14 dBm  | <ul style="list-style-type: none"> <li>• Eliminate the need for an external amplifier</li> <li>• Reduce your test setup costs</li> <li>• Accurately test your nonlinear devices with no compromises</li> </ul>   |
| High compression point level: up to +15 dBm at 70 GHz  | <ul style="list-style-type: none"> <li>• Eliminate the need for internal or external attenuators</li> <li>• Improve calibration and measurement accuracy</li> </ul>  |
| Best test port characteristic performance: up to 50 dB in directivity, source match, and load match  | <ul style="list-style-type: none"> <li>• Reduce measurement uncertainty</li> <li>• Reduce measurement guard bands</li> <li>• Improve productivity</li> <li>• Achieve optimum precision measurements in the R&amp;D lab</li> </ul>  |
| Most convenient automatic calibration system with best accuracy  | <ul style="list-style-type: none"> <li>• Use Precision AutoCal for an easy, one-button method of VNA calibration</li> <li>• Better accuracy than traditional SOLT calibration</li> <li>• Spend less time setting up the VNA for the next production run</li> </ul>   |
| Best device modeling data  | <ul style="list-style-type: none"> <li>• Accelerate your design cycle</li> <li>• Accurately model devices down to DC using calibrated, traceable values starting at 70 kHz</li> <li>• Eliminate the need for concatenation of two VNAs</li> </ul>  |
| Best time domain analysis  | <ul style="list-style-type: none"> <li>• 100,000 points and 700 kHz frequency step size provide the most accurate, highest resolved, low-pass mode measurements</li> <li>• Measure long transmission lines with the best, non-aliasing range</li> </ul>  |
| 4-port single-ended, mixed-mode, and true differential measurements  | <ul style="list-style-type: none"> <li>• Measure all single-ended or mixed-mode responses</li> <li>• Make true mode stimulus measurements</li> <li>• Flexible calibration routines using a Precision AutoCal</li> <li>• Excellent performance from 70 kHz to 70 GHz in baseband mode and 70 kHz to 110, 125, 145, and 220 GHz in broadband mode</li> </ul>                       |
| Broadband VNA system provides single-sweep coverage from 70 kHz to 220 GHz   | <ul style="list-style-type: none"> <li>• Improved power leveling accuracy and stability</li> <li>• Improved power sweep linearity and accuracy</li> <li>• Reduced module size</li> <li>• Reduces complexity of mechanical setup of wafer probe station</li> <li>• Eliminate &gt;\$30K cost of large mechanical positioners</li> <li>• Use smaller probe station plate</li> </ul> |
| Upgradable frequency range, port count, and options  | <ul style="list-style-type: none"> <li>• Reduce initial investment cost</li> <li>• Upgrade only when requirements change</li> <li>• Reduce cost by not having to purchase a whole new instrument</li> </ul>  |
| Industry-leading pulse measurement performance   | <ul style="list-style-type: none"> <li>• Eliminate trade-offs and limitations of older pulse measurement methods</li> <li>• Industry-leading 2.5 ns measurement resolution allows true view of device performance and behavior that may have been missed</li> </ul>  |

# VectorStar™ MS4640B Vector Network Analyzer Series

## Key Features and Benefits (Cont'd)

| Key Features (Cont'd)  | Benefits (Cont'd)  |
|--|--|
| True mode stimulus analysis from 70 kHz to 70/110/145/220 GHz with industry-leading accuracy and stability | <ul style="list-style-type: none"> <li>• Ensures the stimulus signals to the differential device are calibrated and accurate for differential or common-mode operation</li> <li>• 70 kHz low-end frequency ensures more accurate DC term estimation thus maximizing the chances of simulation convergence</li> </ul>   |
| Broadband spectrum analysis features   | <ul style="list-style-type: none"> <li>• SPA available from 70 kHz to 20/40/70/110/125/145, and 220 GHz. Also available for banded configuration to 1.1 THz</li> <li>• Dual SPA mode available: suitable for mixers, amplifiers, harmonics, and spurious testing</li> <li>• SPA available on all ports and the user can define which port to use as the designated SPA port</li> <li>• Several detection types are available in Classical mode: peak, minimum, RMS, and mean</li> <li>• Various math functions can be applied on SPA mode like min hold, max hold, user defined equations</li> <li>• Sources and receivers can be independently configured and setup can be used as a tracking generator</li> <li>• For units that have a dual source, a dual drive option is available. Support for external source control is also possible</li> <li>• Phase synchronization for units with dual source is available. This feature allows users to control and configure the phase between the two sources</li> <li>• Source and receiver attenuator are available with VNA and can be activated in SPA mode. Recommendation: use Option 62 (with attenuator on receiver side) for measuring the spectrum content of high-power devices</li> <li>• Software option: easy to install and upgrade existing user equipment</li> </ul> |

## Application Ready

Discover how you can get better measurement confidence with VectorStar vector network analyzers in both R&D and manufacturing environments. VectorStar VNAs offer accuracy and precision as well as a variety of features and options to cover a wide range of measurements — from S-parameter measurements on microwave filters to pulse distortion or noise figure measurements on mmWave components for use in high-performance radar systems.

## Wide Range of Possible VectorStar Applications:

- Passive components
- Active components
- On-wafer
- Opto-electronic measurements
- Signal integrity
- Antenna measurements
- Frequency conversion devices
- Radar
- Material measurements

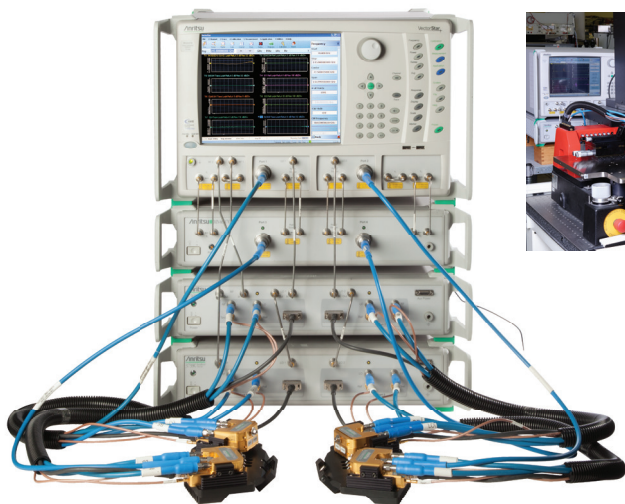

Anritsu's 4-Port ME7838G4 70 kHz to 220 GHz Broadband VNA System

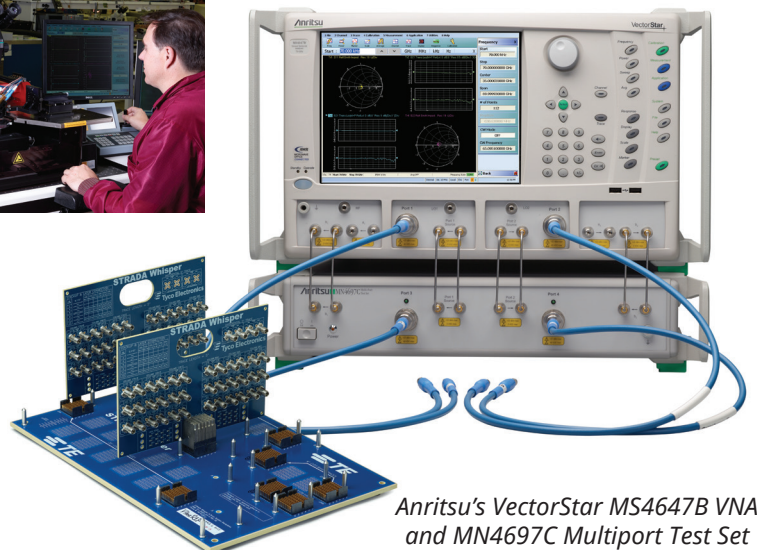

Anritsu's VectorStar MS4647B VNA and MN4697C Multiport Test Set

## Radar

### Bring Your Vision into Resolution with VectorStar MS4640B with PulseView

VectorStar VNAs give you the tools to confidently characterize radar components and subsystems. With industry-leading performance, it can eliminate tradeoffs and limitations of prior test methods. Higher resolution, greater timing accuracy, and longer record lengths, coupled with a graphical setup display, bring your vision into resolution.

The VectorStar MS4640B, with options 35 and 42 (PulseView), offers the most advanced architecture available in a VNA for radar pulse measurements. PulseView, with its industry-leading 2.5 ns VNA pulse measurement resolution, helps meet today's demanding radar pulse measurement requirements with pulse profile, point-in-pulse, and pulse-to-pulse measurements. In addition, real-time setup/display capabilities offer confidence that both setup conditions and measurement results are consistent.

### VectorStar MS4640B Features for Radar:

- Innovative, high-speed digitizer architecture: Enables unprecedented pulse measurement performance (200 MHz digital IF bandwidth)
- Industry's highest resolution pulse measurement: Provides superior performance, executing highly accurate measurements on the most demanding radar applications
- Long record length: Produces measurement of low repetition rate pulses without sacrificing resolution — up to 2.5 s with 2.5 ns resolution
- Graphical setup display: Get instant visual confirmation of initial measurement setup
- Instant results on measurement parameter change: Modify pulse measurement setup parameters and see the measured results instantly
- Four independent measurement windows/receivers: Improves your calibration by adjusting independent receivers to account for any path delays/system timing issues

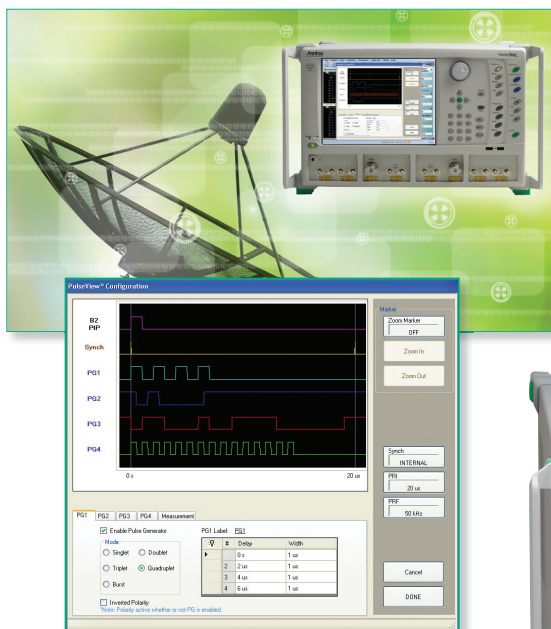

PulseView Configuration Dialog Screen

Anritsu's VectorStar MS4647B and SM6631 Pulse Modulator Test Set

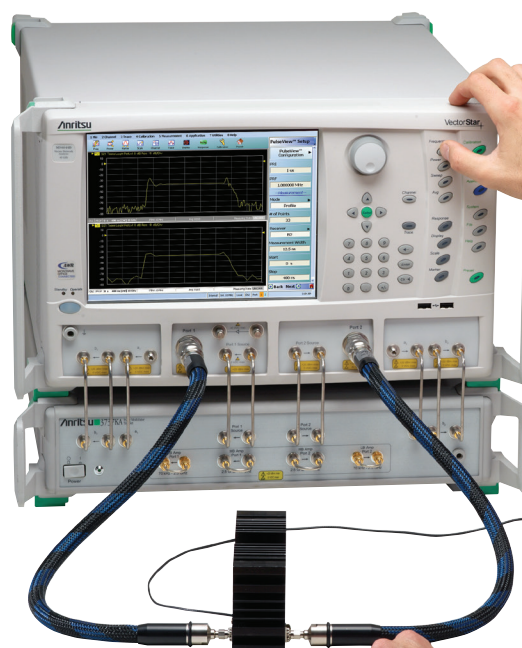

### On-Wafer

#### The Answer to Your High-Stability, Broadband On-Wafer Device Characterization Needs

The VectorStar ME7838 series broadband VNA system — don't let expired calibrations spoil your data.

The VectorStar ME7838 series VNA delivers 102 dB dynamic range at 220 GHz for high-sensitivity measurements across 70 kHz to 110/125/145/220 GHz (up to 1.1 THz with mmWave modules), with typical performance better than 0.1 dB and 1 degrees S21 stability over 24 hours at 25° C. This stable broadband performance means you can make high-accuracy measurements all day with the confidence that your calibration remains rock solid! Spend less time calibrating and more time measuring.

For on-wafer measurements, these VectorStar VNAs offer the smallest, lightest, and easiest to position frequency extension modules that connect directly to wafer probes. Bulky, difficult-to-mount frequency extension modules are a thing of the past, even when working with 4-port measurements. DifferentialView™ enhances accuracy with true mode stimulus (TMS) measurements — giving you confidence to achieve higher product specifications through testing.

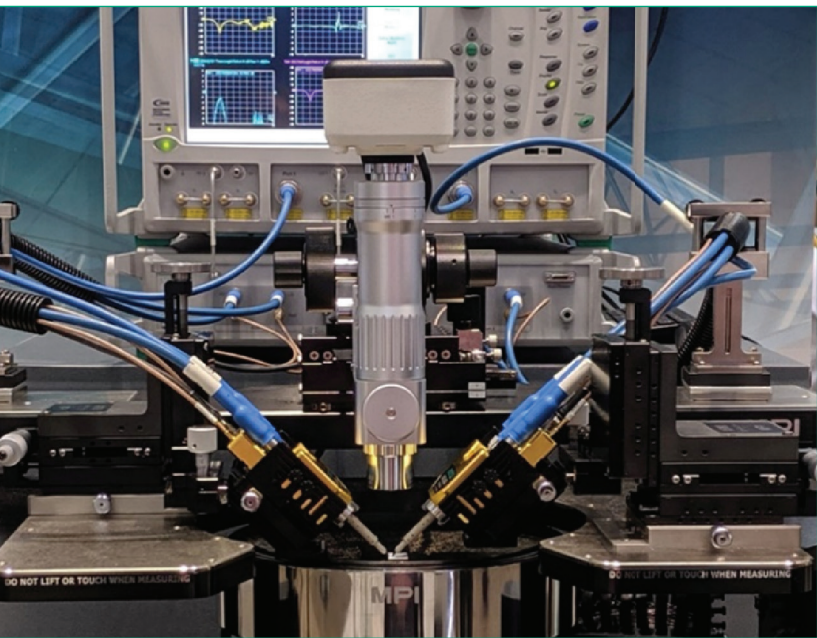

*This Figure Demonstrates the Convenience of Setting up Broadband Measurement to 220 GHz Using the Compact Anritsu mmWave Modules*

#### VectorStar MS4640B Features for Radar:

- Broadest frequency span 70 kHz to 110/125/145/220 GHz
- Obtain the most thorough and accurate broadband measurements
  - Low-frequency measurements eliminate the time-consuming, error-prone concatenation process across the RF, microwave, and mmWave bands
- Industry-leading performance
  - Industry-best dynamic range:
    - 120 dB at 10 MHz
    - 108 dB at 65 GHz
    - 109 dB at 110 GHz
    - 94 dB at 145 GHz
    - 102 dB at 220 GHz
  - Connect directly to probes and further enhance overall system performance
- Extend test time by reducing calibration frequency
  - Compact, integrated frequency extension modules provide enhanced stability as compared with old-style hybrid WG/coax modules
  - Improved stability allows for a single calibration to be performed once for a four hour session or even a day, resulting in an increase in probe station productivity and efficiency
- Broadband VNA system with exceptional real-time power leveling
  - Protect sensitive devices with power sweep control that provides the best power accuracy and stability to power levels as low as -55 dBm
  - Real-time power leveling is more responsive than systems using software leveling, and works with VDI and OML frequency extenders if added to cover higher mmWave bands
  - Real-time power level control of up to 55 dB enables accurate linear gain and 1 dB compression measurements

## Signal Integrity

### See the Signal Integrity of Your Design Come Through — VectorStar with DifferentialView

Today's signal integrity engineers are challenged to meet high data rates, minimize costs, and close the loop of simulation and measurement. The VectorStar MS4640B VNA's industry-leading low-frequency measurement capability (as low as 70 kHz) coupled with an upper range as high as 220 GHz ensure that simulation-busting DC extrapolation and causality issues are minimized and your simulations match reality.

DifferentialView adds TMS capability when you need it with nonlinear devices. High-accuracy time domain and wide dynamic range frequency domain measurements make VectorStar VNAs an ideal tool for signal integrity designers. This solution offers multiport solutions for transmission, reflection, near-end crosstalk (NEXT), and far-end crosstalk (FEXT) measurements on high-speed balanced transmission lines and connectors. Best of all, the VectorStar MS4640B series is fully upgradable — so you can specify the features you need today and add new ones as needed in the future without fear of obsolescence or learning a new test system.

### VectorStar MS4640B Features for Signal Integrity Include:

- Broadest frequency span — 70 kHz to 20/40/70/110/125/145/220 GHz — obtains the most thorough and accurate measurements
- Best time domain analysis: Provides the best combination of accuracy and high-resolution, low-pass time domain results
- Best modeling data: 70 kHz start frequency reduces the risk of DC extrapolation errors in your modeling
- New calibration and de-embedding techniques: Improves the ability to locate discontinuities, impedance changes, and crosstalk issues
- Upgradable in frequency range, port count, and option additions

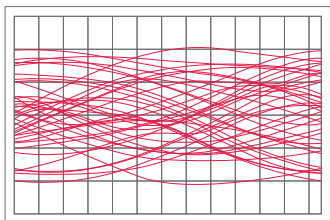

20 Gbit/s transmission with 0.5 dB insertion loss error at 10 MHz

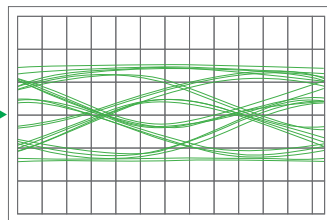

Using accurate, low-frequency S-parameter data reveals a compliant eye pattern that is 85% open

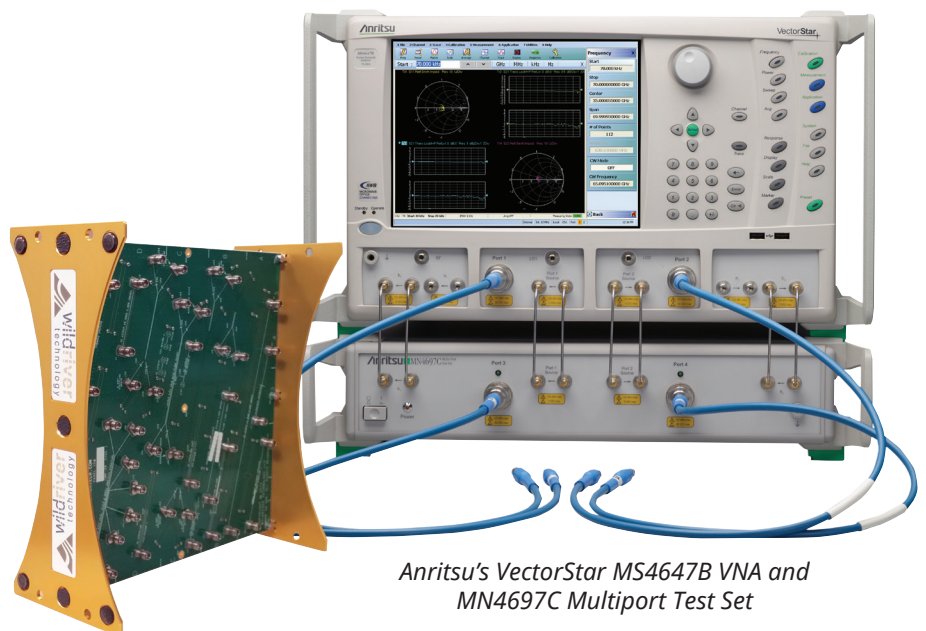

Anritsu's VectorStar MS4647B VNA and MN4697C Multiport Test Set

### Components

#### Confidence in Measurement Leads to Confidence in Component Design

The VectorStar MS4640B series gives you the measurement capabilities you need to develop superior active and passive components.

With the best VNA performance across the widest frequency bandwidth and dynamic range below 2 GHz, the Anritsu VectorStar MS4640B series helps R&D and production test engineers make better measurements faster and accelerate the design cycle. The VectorStar series provides full measurement capabilities across RF, microwave, mmWave, and terahertz regions for components, plus the ability to accurately analyze amplifiers over the entire range of measurements — including pulsed I/V, noise figure, and differential signal stimulation.

The optional 70 kHz start frequency provides accurate modeling and time domain readings, while Precision AutoCal minimizes uncertainty to maximize measurement confidence. DifferentialView provides TMS capability to 220 GHz and the VectorStar series features noise figure measurement leadership to 110 GHz. Best of all, you can easily upgrade the VectorStar MS4640B series in frequency range, port count, and option additions so your investment stays intact year after year.

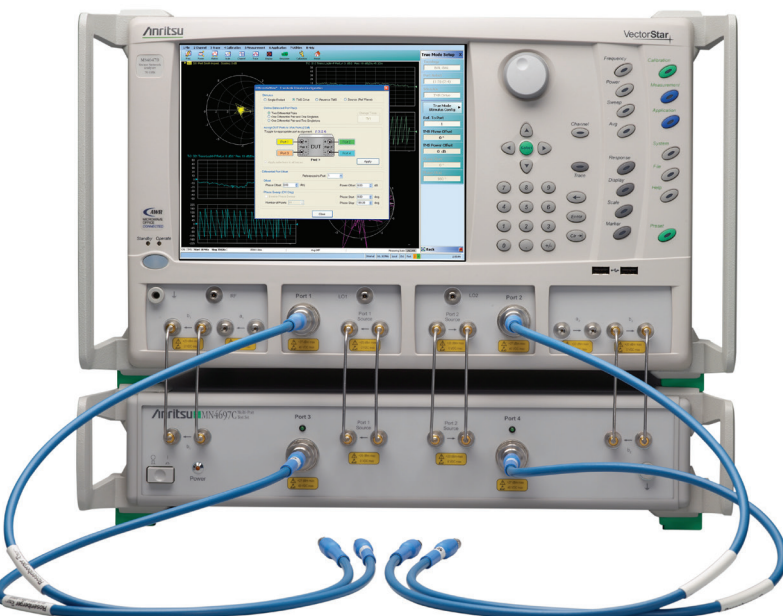

#### VectorStar MS4640B Features for Components Include:

- Highest measurement performance over broadest frequency span: Covers 70 kHz to 20/40/70/110/125/145/220 GHz with one system and eliminates uncertainties due to concatenation of low- and high-frequency data
- Best time domain analysis with hybrid bridge-coupler VNA architecture: Minimize DC extrapolation errors in the time domain with the use of a bridge structure below 2.5 GHz to ensure high-quality, low-frequency S-parameter data capture down to 70 kHz
- Precision AutoCal: Increase measurement confidence on cutting-edge designs without time-consuming sliding load calibrations
- PulseView: Uncover causes of pulse distortion problems with 2.5 ns resolution using PulseView and the VectorStar series IF digitizer option
- DifferentialView: Discover the performance of your differential amplifier
- Noise figure measurement: Measure noise figure to 110 GHz with the VectorStar series unique capability
- Complete upgradability within family: Meet budget targets and protect your investment by buying only what is needed now and upgrading later

Anritsu's VectorStar MS4647B



## Differential Testing

### Achieving Both Accuracy and Throughput for Differential Measurements

For active device and signal integrity engineers who need to measure differential devices and provide high-quality results for use in simulation tools, the VectorStar 4-port VNA provides the ability to perform true mode stimulus differential analysis from 70 kHz to 20/40/70/110/125/145/220 GHz with industry-leading accuracy and stability. While some solutions have a start frequency of 10 MHz with degraded results beginning below 1 GHz, the VectorStar 4-port VNA provides high-quality S-parameter results down to 70 kHz. This ensures more accurate DC term estimation and maximizes the chances of simulation convergence.

When combined with the dual source option (option 31), DifferentialView software provides TMS capability that calibrates, controls, and manipulates the phase and magnitude between the two internal sources. TMS mode ensures that the stimulus signals to the differential device are calibrated and accurate for differential or common-mode operation.

DifferentialView provides continuous measurement display while actively editing key parameters. In contrast, other VNA solutions hide the measurement with configuration panels during editing of parameters and do not display key parameter settings during the measurement.

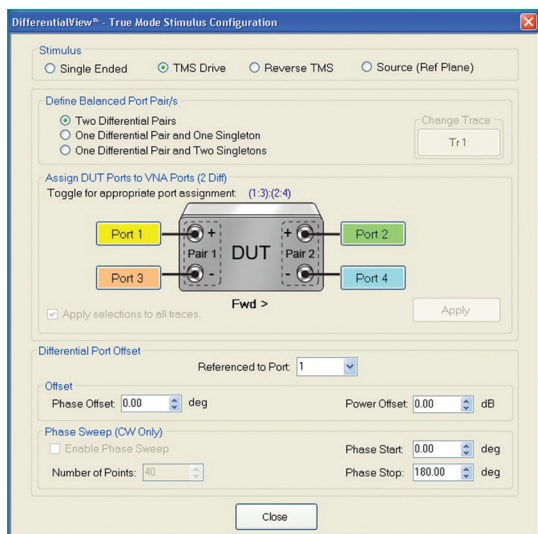

*DifferentialView True Mode Stimulus Configuration*

### Key Features and Benefits:

- Construct an in-phase and out-of-phase relationship between the two differential DUT stimulation signals
  - Provides accurate, calibrated control of two internal sources for complete analysis of differential devices
  - Superior differential phase accuracy means highly compressed, nonlinear devices are accurately characterized and modeled for faster design turns
- Sweep phase relationship between two stimulus signals
  - Verifies device performance over anticipated operating conditions for complete confidence
  - DifferentialView display offers faster manipulation of key parameters, thereby requiring less time searching for device trouble spots
- 70 kHz to 20/40/70/110/125/145/220 GHz frequency range
  - Widest frequency sweep analysis of differential devices
  - Provides lowest start frequency for best DC information with industry-leading dynamic range for superior device characterization and modeling accuracy

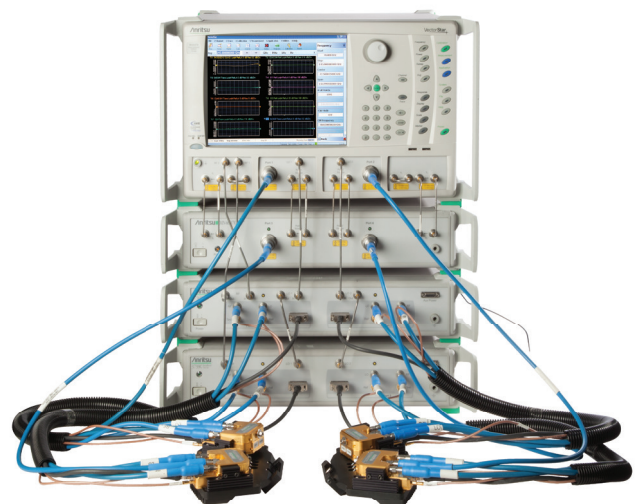

VectorStar ME7838G4 4-Port 70 kHz to 220 GHz VNA

## Pulse Measurements

### Pulse View

The Anritsu VectorStar MS4640B with options 35 and 42 (PulseView) offers the most advanced architecture available in a VNA for radar pulse measurements. It delivers industry-leading performance that eliminates the trade-offs and limitations of prior test methods. Higher resolution, greater timing accuracy, and longer record lengths coupled with a real-time display give you the performance and confidence needed to meet the most demanding radar pulse measurement requirements.

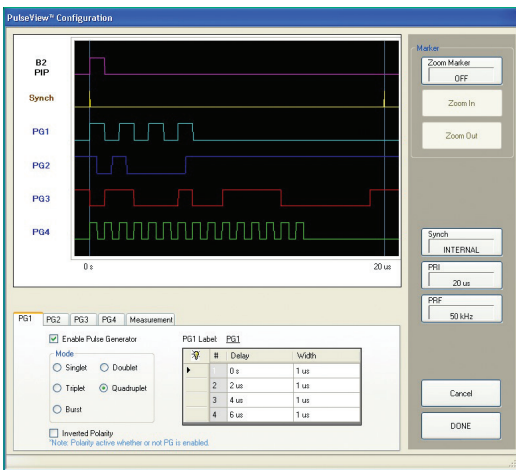

PulseView Configuration Screen

### VectorStar MS4640B Provides:

- An innovative, high-speed digitizer architecture
- The industry's highest resolution measurements
- The longest record lengths
- Independent receiver measurements
- An intuitive graphical configuration tool
- Instant results on measurement parameter changes

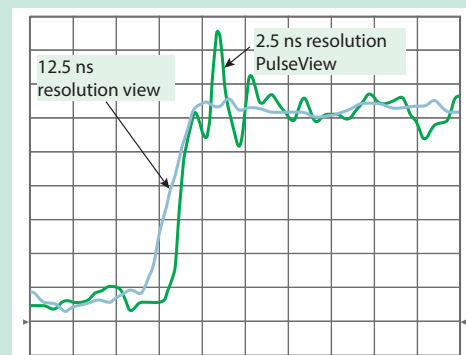

VectorStar VNAs (with PulseView) enable industry-leading measurement 2.5 ns resolution. It enables users to get a true view of their device performance and see behavior they may have been missing. In the example above, the 12.5 ns resolution measurement of a typical VNA does not capture the full magnitude of the signal overshoot. For applications with very sensitive receivers, the full magnitude of the overshoot could be the difference of whether or not a receiver enters saturation, resulting in a number of unwanted effects.

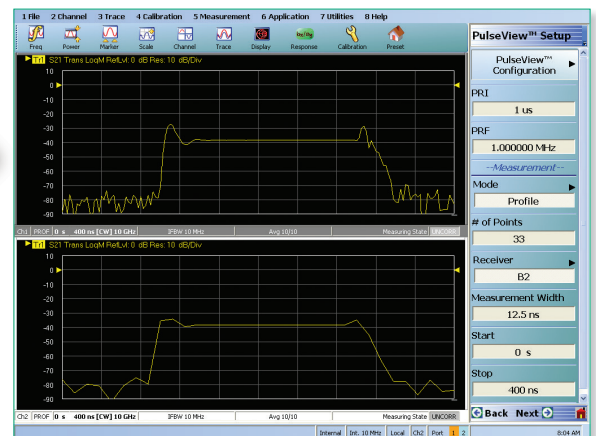
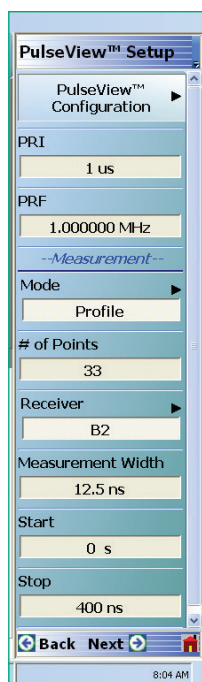

Change Measurement Parameters and See Results in Real Time

## Time Domain Measurements

The time domain option (option 2) allows you to display the performance of the device in the time or distance domain. It also provides a powerful ability to analyze the performance of the device at specific locations. For instance, when analyzing connectors, the distance information provides an indicator of the quality of the connection at different locations within the connector.

### 70 kHz to 70 GHz Provides Unprecedented Resolution

The unprecedented low-end frequency range of the VectorStar VNAs provide a unique opportunity when using time domain analysis, especially when using the popular low-pass step mode. This powerful processing technique provides the highest performance and most versatile set of displays. The low-pass mode requires a harmonically related set of frequencies that start at the lowest frequency possible. A DC term is extrapolated that provides a phase reference, so the true nature of a discontinuity can be evaluated. Now, with a maximum of 100,000 points and a starting frequency as low as 70 kHz, the DC term extrapolation can begin at a near-DC data point. The result is a significant improvement in the capabilities of device analysis when analyzing in the low pass time domain.

The VectorStar VNA continues to offer Anritsu's unique benefit of providing both real and imaginary information when measuring narrowband devices, such as bandpass filters and waveguides. The Anritsu-developed Phasor Impulse Mode provides true impedance information of these types of devices even when operating in time domain bandpass mode.

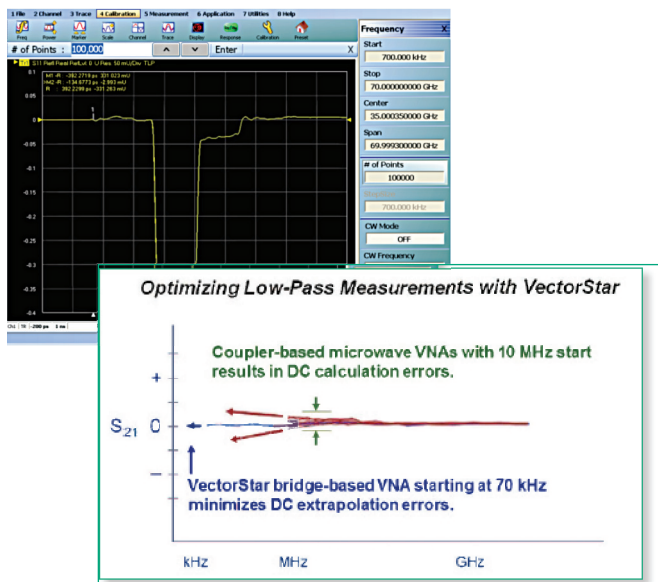

Get Unparalleled Accuracy with VectorStar's 70 kHz Start Frequency

## Unique Time Domain Analysis Benefits

Three important parameters of a VNA have a direct impact on the quality and performance of time domain analysis:

### Frequency Span

The wider the frequency span, the better the time domain resolution. A wide frequency span provides the resolution needed to resolve discontinuities that are too close together to be analyzed by a narrowband VNA. With the maximum broadband coverage of 70 GHz or 110/125/145/220 GHz, all starting at 70 kHz, VectorStar VNAs offers the widest range for the best resolution available.

### Low-End Frequency

The lower the start frequency, the more accurate the measurement. The low-end frequency establishes the DC term when using low pass step mode operation and the DC term establishes the characteristic impedance. With a start frequency as low as 70 kHz, VectorStar VNAs offer an accurate DC reference for the most accurate low pass time domain measurement capability.

### Maximum Data Points

More data points improve aliasing performance and low-pass step mode operation. With a maximum 100,000 points, the most available in the industry, VectorStar VNAs provide the longest non-aliasing range and widest harmonic step calibration for low pass time domain processing.

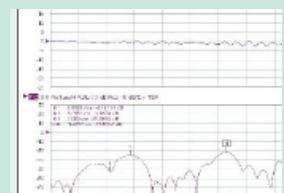
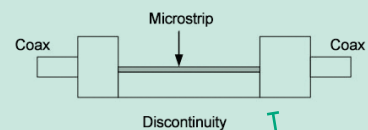

## Component Testing

### Active Measurements Suite

Add the Active Measurements Suite (option 6x) to perform the most popular tests in a convenient, easy-to-use program. This versatile, application-oriented measurement system features:

- Choice of two or four internal step attenuators for forward and reverse sweeps
- Internal bias tees
- Gain compression software to evaluate an over-swept frequency, swept power, or multiple CW frequencies
- Extended power range control

### Noise Figure Measurements

The Noise Figure Measurement options (option 41 for single-ended and option 48 for differential) adds the capability to measure noise figure, which is the degradation of the signal-to-noise ratio caused by components in a signal chain. The noise figure measurement is based on a cold source technique for improved accuracy. Various levels of match and fixture correction are available for additional enhancement. The VectorStar VNA has the only platform capable of measuring single-ended or differential noise figure up to 110 GHz. The VectorStar series offers a unique receiver optimized for noise figure measurements from 30 to 110 GHz.

### Gain Compression Analysis

The VectorStar VNA's powerful gain compression software application includes the ability to measure compression over multiple frequencies. By using the multiple frequency gain compression configuration, the VectorStar solution will sweep power and detect the selected compression point at up to 401 frequencies. The results are then displayed in graphical and tabular format.

### Industry First!

70 kHz to 70/110 GHz VNA Noise Figure Measurements

Single-ended and differential noise figure measurement capability

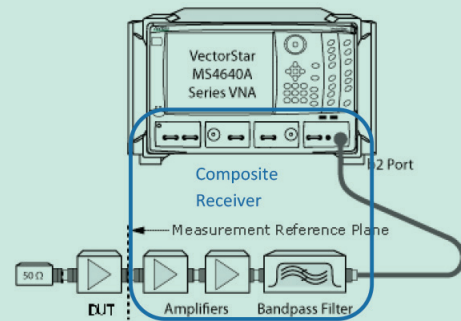

Optimized Noise Receiver for mmWave Measurements from 30 to 110 GHz



VectorStar mmWave Noise Figure Measurement System

3743A mmWave Module with 3744A-Rx Noise Figure Receiver Module

### Mixer Measurements

#### Make Frequency-Translated Device Measurements with a VectorStar VNA

Frequency-translating devices are key components of any communication system, whether they are up-converters, down-converters, or basic mixers. Since their input and output frequencies are different, they require special features and setups for VNA measurements. With the frequency offset capability of the VectorStar VNAs, where the source and receiver are independently synthesized, such measurements are possible and require a much less complicated setup. With special calibration techniques, vector error-corrected measurements are possible for added accuracy, absolute phase, and group delay information.

#### Mixer Setup

The mixer setup application helps to create common mixer measurements with a user-friendly and easy-to-understand GUI with diagrams. The application is also capable of setting up multiple measurement channels to handle any of a suite of possible mixer measurements and to list the required calibration steps. This tool is coupled with a mixer calibration menu system that enables both scalar and vector-corrected measurements.

#### Independent Receiver Offset Control (Option 7)

For more advanced control over measurements, receiver offset control using the Multiple Source Control menu is a capability that independently controls the internal source and receiver as well as up to four external synthesizers. Since there are no constraints on frequency linkage (other than the ranges the hardware is capable of), a wide array of mixer, multiplier, converter, and other specialized measurements can be performed. Some examples include:

- Mixers (up and down conversion, many conversion stages)
- Frequency multipliers, dividers
- Harmonic measurements (including the ability to look at fractional harmonics)
- IMD measurements
- Very high frequency measurements where the source and LO are generated externally

#### Mixer Measurement Types:

- **Scalar** — The scalar measurement technique is the traditional way mixers are measured with a VNA, meaning that only magnitude information is gathered on the DUT. Since the source and receive frequencies are not the same, the VNA does not have a phase reference to make a phase measurement.
- **Vector Error-Corrected (without a characterized mixer)** — All mixer parameters, where the input and output frequencies are the same, can be performed with standard VNA calibrations. Parameters that meet this criterion are match and isolation terms.
- **Vector Error-Corrected (using a characterized and de-embedded mixer)** — Included with the Receiver Offset option is the NxN Mixer Calibration and Measurement utility, providing an accurate method of measuring frequency-translated devices. The utility provides both magnitude and phase information, as well as the ability to measure absolute phase and group delay. By measuring the response characteristics of device pairs, the VectorStar VNA will solve and de-embed the device characteristics. The NxN application module includes capabilities for characterizing and de-embedding the IF path of frequency translation device measurements and delivering a real-time display of the de-embedding characteristics of the DUT for magnitude and absolute phase.

## Broadband/mmWave System Solutions

### Industry's Only 70 kHz to 110/125/145/220 GHz Broadband Vector Network Analyzer — DC to Daylight

Finally, an instrument that truly lives up to the challenge. The VectorStar ME7838 broadband system series provides an incredible frequency span of 70 kHz to 110/125/145/220 GHz through a single coaxial connection. Operation down to 70 kHz provides 8 additional octaves of low-end frequency information. With 70 kHz measured data, device modeling software can significantly improve DC extrapolation calculations, thereby increasing the accuracy of their models.

### On-Wafer Measurements

The VectorStar ME7838 broadband VNA series is a high-performance measurement solution offering the best overall performance for on-wafer measurements including:

- A wide range of on-wafer optimal calibration choices:
  - SOLT/SOLR, TRL/LRL/LRM, A-LRM™, multi-line TRL
- Embedding/De-embedding including the ability to cascade multiple networks for extracting fixtures or embedding networks
- Compatibility with WinCal and IC-CAP
- High port power to overcome insertion losses at the probe tip
- Flat power calibration
- Merged calibrations

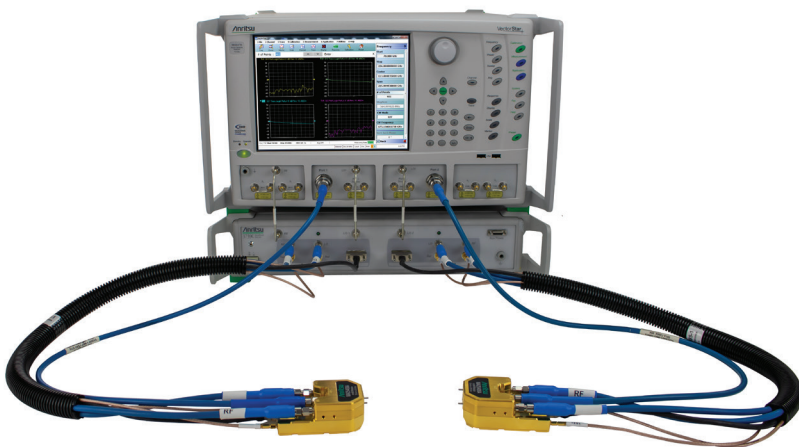

VectorStar ME7838G Broadband 220 GHz System

### Key Features

- Continuous broadband frequency coverage from 70 kHz to 110/125/145/220 GHz using a 1 mm, 0.8 mm, or the Anritsu G series 0.6 mm test port
- Banded mmWave operation up to 1.1 THz
- Industry-best dynamic range: 120 dB at 10 MHz; 108 dB at 65 GHz; 109 dB at 110 GHz; and 94 dB at 145 GHz; 102 dB at 220 GHz
- Industry-best stability: performance better than 0.05 dB and 0.5 degrees S21 stability over 24 hours at 25° C, typical
- The broadest frequency span from 70 kHz to 220 GHz combined with 100,000 data points provides the industry's best time domain resolution
- Kelvin bias tees located close to the DUT provides force, sense, and ground for optimum performance

### Applications

- Broadband characterization
- Parameter extraction
- Device modeling
- On-wafer measurements
- mmWave measurements



Anritsu's MA25400A mmWave 220 GHz Module

### On-Wafer Device Characterization Measurement Solutions

#### Balancing Accuracy and Throughput for Broadband Measurement

Semiconductor manufacturing test engineers face increasing challenges related to broadband mmWave on-wafer testing. Developing accurate models often requires measuring frequencies that range from near DC up to 100+ GHz. Achieving accurate, stable measurements over extended time periods is a challenge for foundries and fabless semiconductor companies that require extensive testing of on-wafer devices.

#### Achieving Both Accuracy and Throughput for Broadband Measurements

The VectorStar ME7838 broadband system series has been uniquely designed to meet on-wafer device characterization needs from 70 kHz to 110/125/145/220 GHz (and even up to 1.1 THz with waveguide-banded mmWave modules). It allows semiconductor test engineers to achieve accurate, stable measurements over extended time periods. The improvement in measurement efficiency allows these engineers to better characterize devices, more confidently set product specifications, and test more products during production.

#### Key Features

- Continuous broadband frequency coverage from 70 kHz to 110/125/145/220 GHz using a 1 mm, 0.8 mm, or the Anritsu G series 0.6 mm test port
- Banded mmWave operation up to 1.1 THz
- Industry-best dynamic range: 120 dB at 10 MHz; 108 dB at 65 GHz; 109 dB at 110 GHz; and 94 dB at 145 GHz; 102 dB at 220 GHz
- Industry-best stability: performance better than 0.05 dB and 0.5 degrees S21 stability over 24 hours at 25° C, typical
- The broadest frequency span from 70 kHz to 220 GHz combined with 100,000 data points provides the industry's best time domain resolution
- Kelvin bias tees located close to the DUT provides force, sense, and ground for optimum performance

#### Applications

- Broadband characterization
- Parameter extraction
- Device modeling
- On-wafer measurements
- mmWave measurements

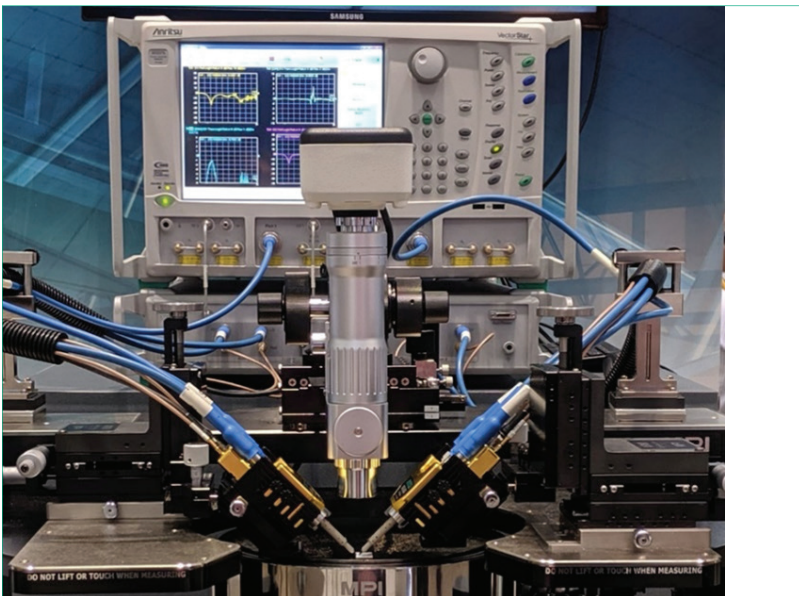

*Anritsu's VectorStar ME7838G Broadband System Integrated into an On-Wafer Probe Station*

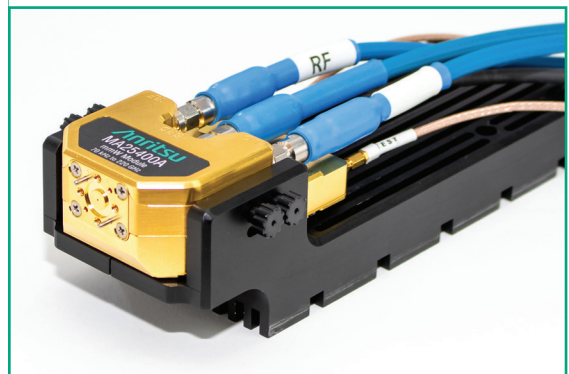

*Anritsu's MA25400A mmWave 220 GHz Module*

## 4-Port Testing from 70 kHz to 70/110/125/145/220 GHz

The VectorStar MS4640B 2-port VNA can be used in conjunction with an external MN469xC series 4-port test set and mmWave modules for 70 kHz to 110/125/145/220 GHz single-ended, mixed-mode, and true differential mode S-parameter measurements. The VectorStar 4-port solution is ideal for today's highly integrated multipoint assemblies, common three-port devices (such as combiners, diplexers, and couplers), and balanced linear devices.

Two models are offered: the multipoint VectorStar MN4694C in K and the multipoint VectorStar MN4697C in V connector outputs. The former can be used with the VectorStar MS4642B or MS4644B VNA for 70 kHz to 20 GHz or 40 GHz coverage, respectively. The latter can be used with the VectorStar MS4647B VNA for 70 kHz to 70 GHz coverage. The only option that is necessary on the base 2-port VNA is the direct access loops available with option 51. Option 70 is needed for coverage down to 70 kHz.

For signal integrity measurements on high-speed, balanced transmission lines and connectors, the VectorStar 4-port solution offers an unprecedented 70 kHz low-end operation with upper frequencies to 70/110/145/220 GHz. Direct measurements from practically DC to 110/125/145/220 GHz, high-accuracy time domain, and wide dynamic range frequency domain make the VectorStar 4-port the ideal tool for designers concerned with signal integrity.

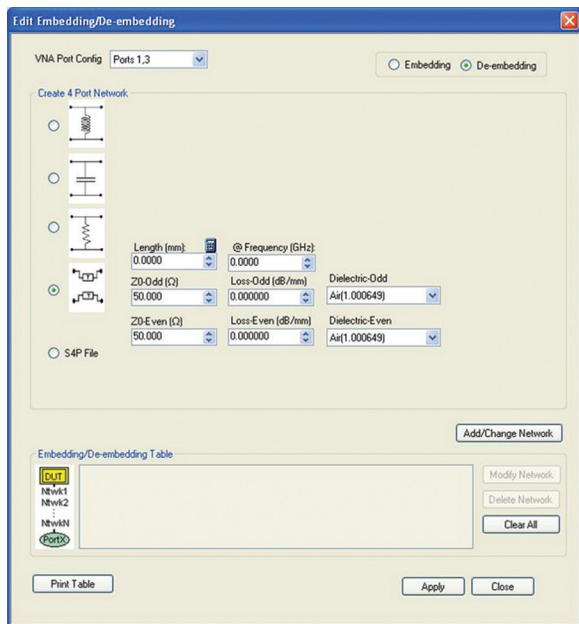

### Advanced 4-Port Capabilities

- 16 single-ended S-parameters
- 16 mixed-mode S-parameters
- Flexible port assignments
- Differential, common, and mixed-mode S-parameters
- 1-, 2-, 3-, and 4-port calibrations using AutoCal, SOLT/R, SSLT/R, SSST/R, LRL/M, A-LRM
- Arbitrary impedance transformation
- Hybrid-Cal for combining 1- or 2-port calcs to create 2-, 3-, or 4-port calcs with the addition of thru/reciprocal steps (ideal for mixed-media applications)
- FlexCal for a calibration to be used for a lesser port correction, thus faster measurements
- Embedding and de-embedding of 2- or 4-port networks using circuit elements or .snp files
- Extensive network extraction of one, two, or four 2-port networks or two 4-port networks, including /2 capability for extracting fixtures that cannot be calibrated at the inner plane
- Universal Fixture Extraction (UFX) supports 4-port test fixture network extraction when a full set of calibration standards are not available

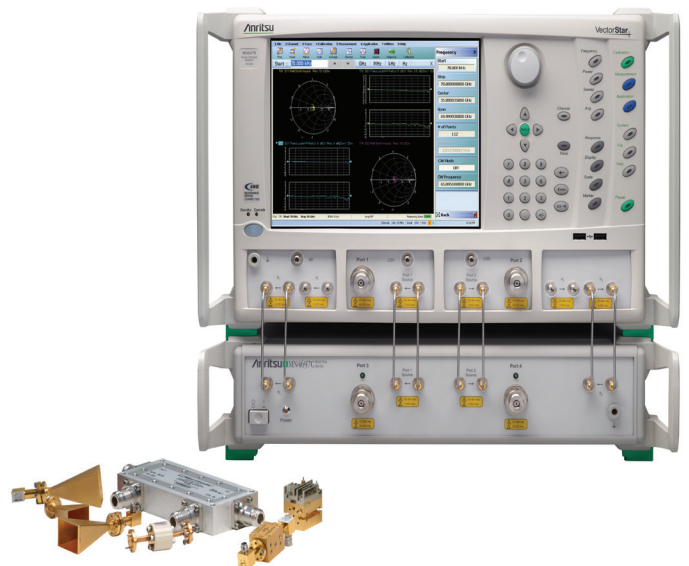

Anritsu's VectorStar MS4647B with MN4697C Multiport Test Set



## Upgradability

### Best Broadband Dynamic Range

- 120 dB at 10 MHz
- 108 dB at 65 GHz
- 109 dB at 110 GHz
- 94 dB at 145 GHz
- 102 dB to 220 GHz

Thanks to incorporating two optimized VNAs in one instrument, VectorStar VNAs deliver full spectrum performance. You're no longer subject to losing dynamic range at the low-end of the frequency range due to coupler roll-off, nor will you have to worry about the high-end due to a drop in available port power. By utilizing high directivity couplers for the microwave region and resistive bridges for the RF range, critical performance parameters (such as directivity and available measurement power) are maximized. Add to that a receiver compression level up to 20 dB higher and a noise floor up to 15 dB lower. The result is a VNA with the best overall dynamic range over the widest frequency range available in the industry.

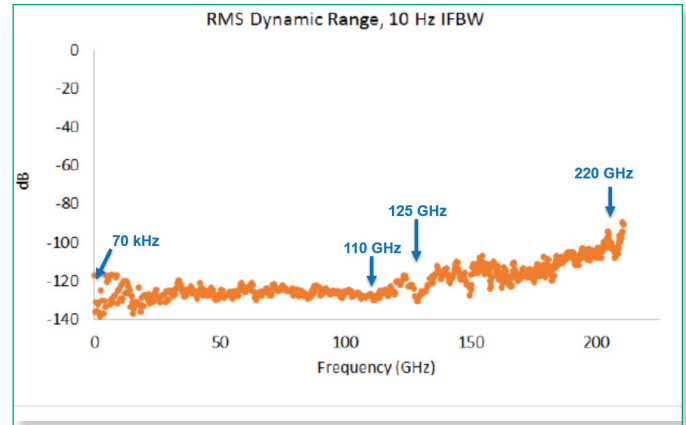

*Dynamic Range of VectorStar ME7838G System at the 0.6 mm Test Port from 70 kHz to 220 GHz*

### Purchase Only What You Need Now and Upgrade Later When Your Needs Change

The Anritsu VectorStar series of performance VNAs is designed with upgradability in mind. Have the peace of mind that you can start with the basic 2-port 20 GHz model knowing that you can upgrade frequency coverage to 70 GHz or even 110/145/220 GHz, as well as the number of ports and options when requirements change. With other manufacturers, you will need to decide ahead of time what your future needs may be or you may end up with an expensive system that will not grow with your needs.

| Part Number | Description       |
|-------------|-------------------|
| Base Models |                   |
| MS4642B     | 10 MHz to 20 GHz  |
| MS4644B     | 10 MHz to 40 GHz  |
| MS4647B     | 10 MHz to 70 GHz  |
| ME7838Ex    | 70 kHz to 110 GHz |
| ME7838Ax    | 70 kHz to 125 GHz |
| ME7838D     | 70 kHz to 145 GHz |
| ME7838G     | 70 kHz to 220 GHz |

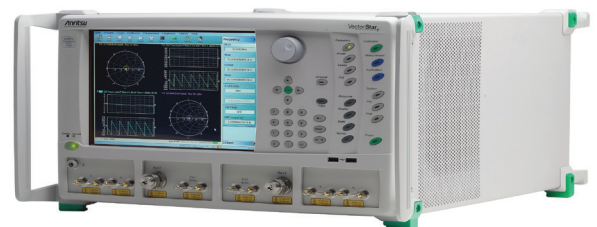

*VectorStar™ MS4640B Vector Network Analyzer Series*

## Accuracy Enhancements

### Embedding/De-embedding

The de-embedding capabilities of the VectorStar VNAs can be used to remove test fixture contributions, modeled networks, and other networks described by S-parameters (.s2p files) from the measurements. Similarly, the embedding function can simulate matching circuits for optimizing amplifier designs or simply adding effects of a known structure to a measurement.

### Adapter Removal

Quickly and easily characterize and “remove” the effects of an adapter attached during calibration and not used during device measurements. This de-embedding technique is useful when measuring non-insertable devices and optimizes the calibration procedure. Using this method requires only two normal insertable SOLT calibrations. VectorStar VNAs retain both calibrations in internal memory and automatically extract the effects of the adapter during measurement.

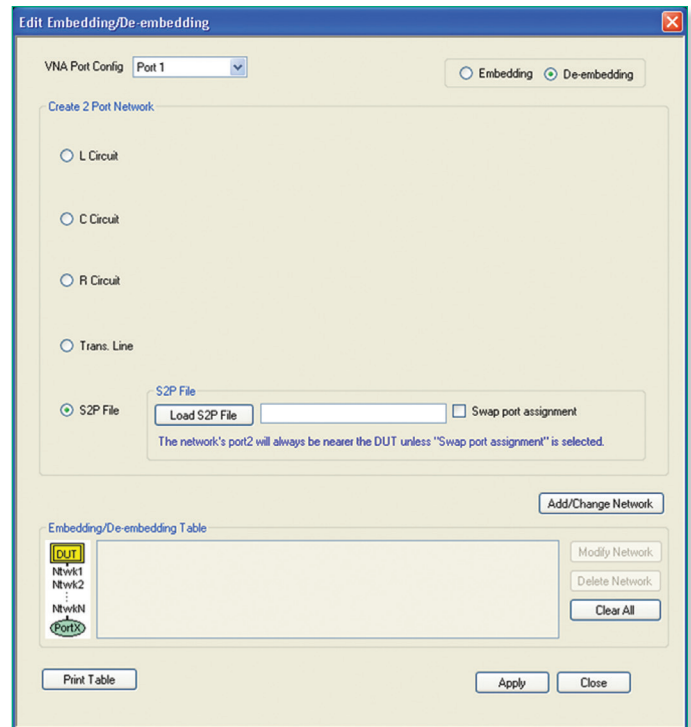

The VectorStar Universal Fixture Extraction option (UFx) provides advanced network extraction capabilities beyond the standard methods. The option provides increased range of calibration choices for on-wafer and fixture calibrations when a full set of calibration standards are not available. An example would be when only an open and/or short at the end of a customized fixture is possible. This capability is quite valuable in signal integrity and device characterization applications where migration to higher frequencies in support of higher data rates as required in 4G and 5G systems, backhaul, and data centers.

### Test Port Power with Power Meter Accuracy

S-parameter measurements of active devices, such as amplifiers, require accurate knowledge of the input and output power levels of the device. Also, for optimum swept frequency gain compression measurements, the output power of the analyzer test port should be flat over the frequency range. The VectorStar MS4640B VNA provides an automated power flatness calibration program for characterizing test port power. When calibrated with power meters such as the Anritsu ML24XX series power meters, the calibration routine automatically stores a power correction table in the analyzer for later recall. The result is a VNA with flat, leveled power across the entire sweep range and with power meter accuracy.



Anritsu's VectorStar MS4647B with ML2438A Power Meter

### Opto-Electronic Testing

The VectorStar ME7848A opto-electronic network analyzer (ONA) system includes the VectorStar VNA combined with a traceable calibration O/E detector module and an E/O converter. The VectorStar ME7848A ONA enables the measurement of domain-transfer devices such as optical modulators, modulated lasers, optical transmitters, photodiodes, photoreceivers, and transceivers. The VectorStar system facilitates the measurement of electrical-to-optical (E/O) and optical-to-electrical (O/E) transfer function in terms of bandwidth, flatness, and phase linearity (group delay).

Three system options provide the ability to measure optical devices at the 850, 1310, and 1550 nm wavelengths. System modularity offers the ability to add detectors and/or converters with different wavelengths to expand system capabilities without the need for additional VNAs.

- Fast and accurate opto-electronic measurements — The VectorStar ME7848A-0200 series ONA, when calibrated using the MN4765B O/E module, enables error-corrected transfer function, Group Delay, and Return Loss measurements of E/O and O/E components and subsystems.
- MN4765B O/E calibration module — The O/E calibration module is a photodiode reference standard detector that is thermally stabilized to minimize drift over temperature.
- MN4775A E/O converter — The E/O converter includes a calibration module with a lithium niobate (LiNbO<sub>3</sub>) modulator stabilized by a fully automatic bias controller and tunable or fixed wavelength laser source. Excellent converter stability ensures characteristics remain consistent during measurement of O/E DUT detectors and receivers.
- National Institute of Standards and Technology (NIST) derived characterization — Magnitude and phase characterization of the O/E calibration module is obtained using a primary standard characterized by NIST and held in the Anritsu Calibration Lab.
- Internal biasing — Accurate bias voltage to the photodiode is maintained internally.
- Measurement flexibility — The VectorStar VNA can be easily switched between electrical and opto-electronic measurements. Only one 12-term calibration is required, which can be applied to E/E, E/O, and O/E setups. This makes it flexible and easy to use for all high-speed device measurements.

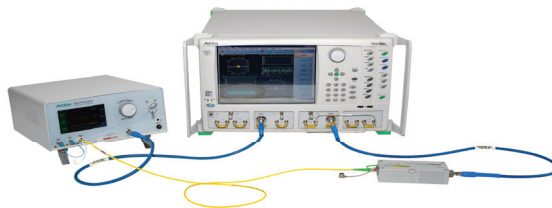

#### MN4775A E/O Converter

The MN4775A E/O converters offer wavelength support of 850 nm at 40 GHz and 1310/1550 nm with frequency response to 70 GHz. Each converter incorporates a telecommunication-grade lithium niobate (LiNbO<sub>3</sub>) modulator that is stabilized by an automatic bias controller. The converter also includes a tunable or fixed wavelength laser source. The 1310 and 1550 nm versions also have loop-back access for operation using an external laser.

#### MN4765B O/E Calibration Module

The MN4765B is the base calibration module and, when combined with appropriate options, can be used with the Anritsu VNAs to perform accurate, flexible, and cost-effective characterization of opto-electronic devices. Option 40 offers opto-electronic measurements of devices from 70 kHz to 40 GHz in the 850 nm range. The 1550 and 1310 nm wavelengths are supported with the option 70 and 71 respectively. These O/E calibration modules consist of an InGaAs photodiode that converts modulated optical signals to electrical signals, and includes additional circuitry for temperature and bias stability.



## SPA Measurements

### Anritsu VectorStar VNA Spectrum Analysis Option 49

Every electronic device or component that is characterized using a Vector Network Analyzer, at some point, also undergoes spectrum analysis to check various parameters or is used for troubleshooting. The following measurements are examples of the various parameters:

- Harmonics (3rd, 5th, 7th, etc.) Measurements
- Spurious Measurements
- Distortion Measurements
- For Spectral Content of the Device

All the above measurements require the device under test (DUT) to be detached from the VNA setup and attached to a spectrum analyzer. The process can become tedious, time consuming, and prone to errors. With the inclusion of a spectrum analysis option in the VectorStar VNA, users can make both VNA based S-parameter measurements and spectrum measurements in a single connection with ease and accurate results.

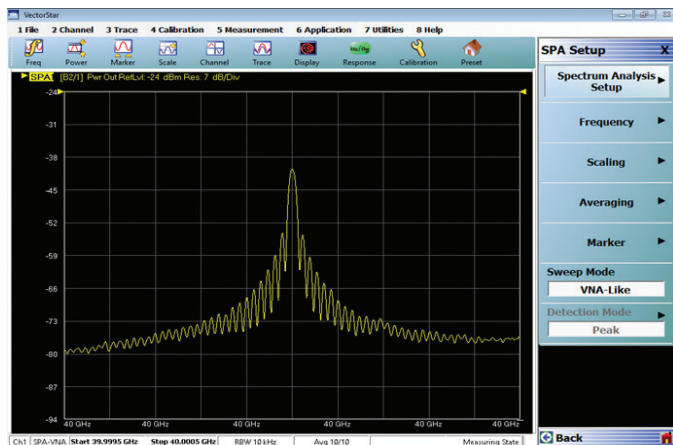

VectorStar Spectrum Analysis

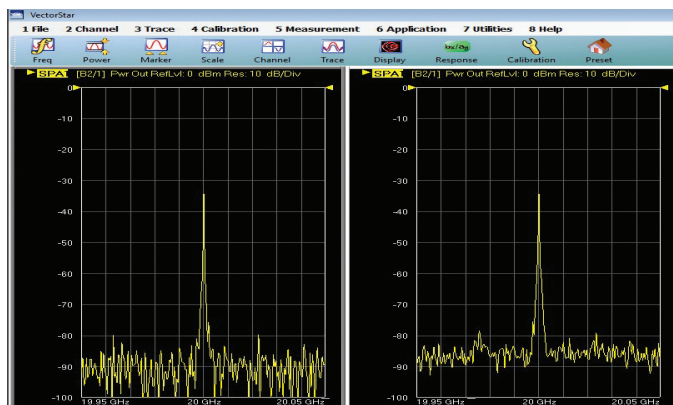

VNA Point Based and Classical Modes

### Main Highlights and Features of VectorStar Spectrum Analysis (SPA) Option 49

#### Dual SPA Mode Available for Usage as Per Testing Requirements

- VNA-like (point based sweep)
  - Suitable for accurate and fast spectrum measurements when frequencies of interest are already known
  - Ten times faster than the classical spectrum analysis mode
- Classical mode (traditional spectrum analyzer)
  - Suitable for viewing entire spectral content of a device or when the frequencies of interest are not known
- Simultaneous, sequential S-parameter and spectrum analysis for viewing VNA-like and spectrum analyzer-like responses of the DUT
- All VNA related benefits are also available in SPA mode: embedding, de-embedding, power calibration (source and receive), reference plane extension, etc.
- Make SPA measurements at the DUT reference input or output plane like VNA measurement
- Zero Span mode available
- Support for making modulated measurements\*

\* Refer to 10410-00318 MS4640B VectorStar measurement guide for more information

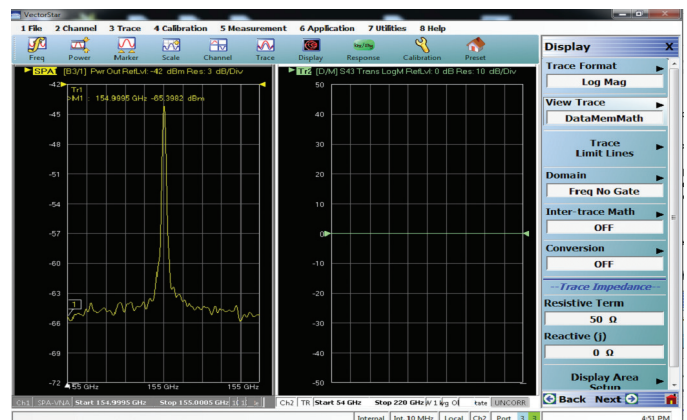

SPA/VNA View on a Single Screen

SPA Measurements

Key Features and Highlights

- SPA available from 70 kHz to 20/40/70/110/125/145, and 220 GHz. Also available for banded configuration to 1.1 THz
- Dual SPA mode available: suitable for mixers, amplifiers, harmonics, and spurious testing
- SPA available on all ports and the user can define which port to use as the designated SPA port
- Several detection types are available in Classical mode: peak, minimum, RMS, and mean
- Various math functions can be applied on SPA mode like min hold, max hold, user-defined equations
- Sources and receivers can be independently configured and can be used as a tracking generator
- For units that have a dual source, a dual drive option is available. Support for external source control is also possible
- Phase synchronization for units with dual source is available. This feature allows users to control and configure the phase between the two sources
- Source and receiver attenuators are available with VNA and can be activated in SPA mode. Recommendation: use Option 62 (with attenuator on receiver side) for measuring the spectrum content of high-power devices
- Software option: easy to install and upgrade existing user equipment

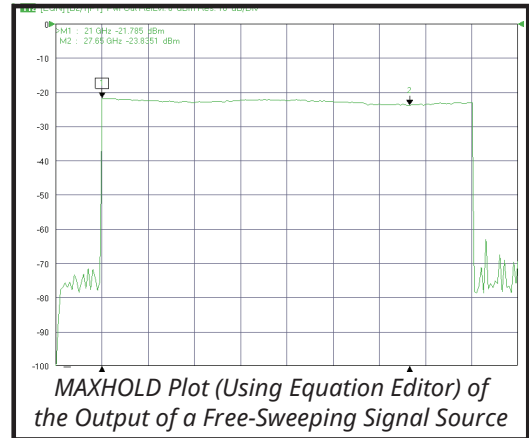

Equation Editor (Max Hold) Example



Independent Tracking Control of Sources and Receivers – Showing a 155 GHz Tracking Mode

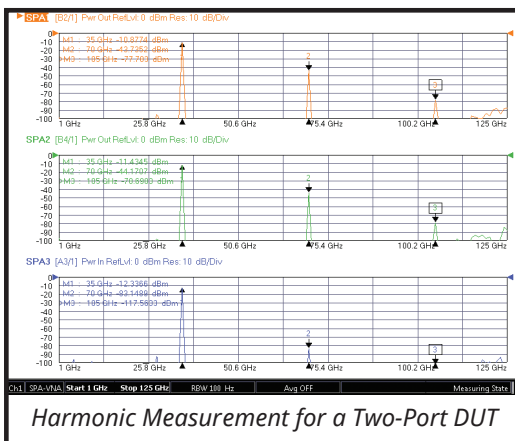

Harmonic Measurement Example

Specifications Overview

- Resolution bandwidth (RBW) range: 1 Hz to 1 MHz
- Displayed measurement points: up to 25000 (100000 in a single channel configuration)
- DANL at test port: -123 dBm/Hz to 70 GHz (MS4647B, no loop options, above 10 MHz)
- Third Order Intercept (TOI):
  - >33 dBm for 1 to 70 GHz (typical) MS4647B
  - >33 to 40 GHz for (typical) MS4644B and to 20 GHz for MS4642B
- Sweep time: 201 display points, 1 MHz RBW, single trace
  - < 40 ms, 10 MHz to 20 GHz (typical), VNA-like mode
  - < 60 ms, 10 MHz to 70 GHz, VNA-like mode (MS4647B)
  - < 0.7 s, 10 GHz span, Classical mode
  - < 1.4 s, 100 MHz to 20 GHz, Classical mode

### Calibration Choices

#### Optimum Measurement Accuracy for a Wide Range of Application Environments

- Precision AutoCal module for automatic calibrations
- SOLT/SOLR for traditional mechanical calibrations
- TRL/LRL/LRM for metrology-grade accuracy
- A-LRM, SSLT to SSSR for on-wafer, waveguide, and other unique requirements

#### Precision AutoCal

The most efficient calibration solution:

- Reduces calibration time and potential operator errors
- Improves accuracy over traditional SOLT by utilizing innovative characterization and calibration algorithms
- Performs the widest frequency span calibration in a single, automatic calibration module: 70 kHz to 70 GHz
- Provides the largest number of internal characterization points for best accuracy simultaneously over a broad and narrow frequency span
- Combines the most number of characterized points with up to 100,000 instrument calibration points – all with a single click

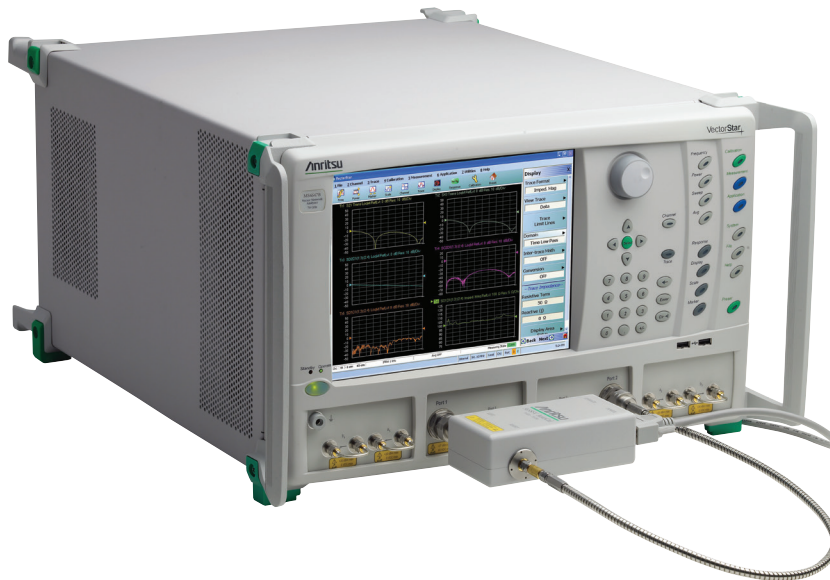

*VectorStar MS4647B with 36585V AutoCal*

The concept of AutoCal was first introduced to decrease the possibility of improper connections or connecting the wrong standard. Combining over-determined characterization algorithms with Anritsu's Multiple Line Calibration Kit, Precision AutoCal provides unprecedented accuracy. It now surpasses the accuracy of mechanical standards kits, resulting in a simple-to-use calibration method providing metrology-grade performance.

### Calibration Choices (Cont'd)

#### Fast, Easy, and Accurate Non-Insertable Measurements

Non-insertable measurements require the use of an adapter during the thru calibration setup. Oftentimes, extraction methods utilizing .s2p files are used to remove the effects of the adapter. This requires yet another calibration and a challenge to perform the measurement with the desired degree of accuracy. That's why the Precision AutoCal module is available in a variety of connector configurations and can easily connect the non-insertable test ports to provide the most accurate alternative to non-insertable calibrations.

For cases where the correct connector version of AutoCal may not be available, VectorStar VNAs provide an easy method of incorporating an adapter during the thru calibration step. This improved method eliminates the need for additional .s2p files. The procedure works in conjunction with the insertable AutoCal, and simply requires reversing the combination and re-calibrating. The result is an automatic adapter removal calibration using only four connections (unlike other methods that require as many as 22 reconnections during the calibration procedure).

Substantial advancements in automatic calibration performance with Precision AutoCal's superior switching of internal standards, coupled with the highest available calibration points, provides the most accurate, stable, and user-friendly automatic calibration system available for a VNA. The unique topology of the AutoCal module provides a number of significant advances during the automatic calibration procedure:

- Hybrid GaAs PIN diode technology, with its unique standards mapping technique, provides a wide range of impedance reference points without the high insertion loss of cascading multiple switches. With a wide variety of impedance points to choose from, the VectorStar VNA's over-determined algorithm finds the optimum characterization combination to provide the fastest, most accurate calibration possible. The higher number of available reference points, coupled with over-determined characterization algorithms, provides wider reference coverage of the impedance map, increased source match accuracy, and minimization of interpolation errors across the entire Smith Chart.
- Turnstile approach to impedance switching provides a low insertion loss path between ports 6 dB or better for a far more accurate thru-path characterization and superior transmission tracking performance.
- Get an accurate thru-path characterization without the need to reconnect test port cables or perform an additional calibration step as with other electronic calibrators.
- A maximum number of over-characterized points, combined with an optimal segmented sweep, results in a calibrated step size as narrow as 20 kHz (compared to 10 MHz for other electronic calibrators). The result is low interpolation errors, even when sweeping extremely narrow band ranges.
- Availability of the SOLR calibration routine for applications where transitions in connector types are required.
- AutoCal can also be characterized in the field with an adapter. No need to send the module back to the factory. When finished, the adapter can be removed and the initial characterization file restored to its original state.



### Calibration Choices (Cont'd)

#### Unsurpassed Accuracy

Accuracy is determined by numerous system performance aspects, such as corrected test port characteristics and trace noise. Uncertainty curves provide a graphical representation of total system accuracy and offer a complete picture of precise and expected measurements. The overall test port characteristics of the VectorStar VNAs are unsurpassed, whether compared to traditional SOLT calibration kits or automated calibration methods. For example, note the significant advantage in accuracy of the VectorStar VNAs when calibrated with the Precision AutoCal compared to other VNAs calibrated with similar automated calibration modules (or even with traditionally more accurate mechanical calibration kits using sliding loads). Further proof that not only will VectorStar VNAs provide the most accurate measurements, they are also easy to calibrate and operate.

#### LRL/LRM Multiple Line Calibration Kits

Utilizing Anritsu's 3657 series multiple line calibration kits, the VectorStar VNA can be calibrated to unprecedented levels of performance. The six male-to-male, beadless airlines provide the highest level of quality in accordance to the NIST traceable impedance standard. When calibrated with the internal LRL/LRM calibration routine, the VectorStar VNA's corrected directivity and load match is specified to be up to 50 dB.



*Model 3659 0.8 mm Calibration and Verification Kit*

#### 70 kHz to 70 GHz of Fully Specified, Traceable Measurements

Anritsu has pioneered metrology measurements using airline technology. Airlines establish the characteristic impedance of the measurement system and are traceable through mechanical measurements. Traceable, beadless airlines are then used to confirm performance of a calibrated VNA. Anritsu has established a traceable path for airlines up to 70, 110, and 145 GHz. A traceable path to 70 kHz has also been established by using DC coupled thermal power sensors. Thus, utilizing a combination of traceable Anritsu-designed thermal power sensors and traceable airlines, calibration and specifications covering the entire 70 kHz to 70/110/145 GHz range in a single sweep is achieved. For measurements up to 220 GHz using the ME7838G(G4) system, on wafer calibration substrate standards are used for traceability.

#### 36580 Series AutoCal and Precision AutoCal

The Anritsu 36580 series AutoCal modules are automatic calibrators that provide fast, repeatable, and high-quality coaxial calibrations up to 70 GHz. These modules contain precisely characterized calibration standards that aid in the removal of normal systematic errors of VNAs. These calibrators are ideal for the manufacturing environment where speed, accuracy, and reliability are important.



*36585V Precision AutoCal*



### Calibration Kits and Accessories

#### 3650 Series Calibration Kits

Accurate operation of your VectorStar VNA is ensured by using Anritsu's precision coaxial SOLT (sliding load) calibration kits. These kits include precision components for calibrating measurements in SMA, 0.8 mm, 1 mm, 3.5 mm, K connector™, and V connector™. For waveguide measurements, standard kits offer offset-short calibration capabilities. Anritsu's microstrip calibration kits include all the components necessary for SOLT, LRL, and LRM calibrations using the Anritsu 3680 series Universal Test Fixture.



3650 series Coaxial Calibration Kits

#### 3657 Series Multiple Line Calibration Kits

The Anritsu 3657 series multiple line calibration kits provide six V connector airlines ranging from 15.00 mm to 49.84 mm in length. All airlines are configured with male-to-male connectors. The airlines can be used to calibrate the VectorStar VNA using TRL/LRL/LRM calibration techniques. Using the proper combination of airline lengths and the VectorStar internal calibration routines, the VNA can be consistently calibrated to 50 dB directivity. Insertion and removal tools are also supplied with the kits. The kits can be provided with and without fixed offset shorts.



3657 Series Multiple Line Calibration Kits

#### 3660 Series Verification Kits

Anritsu offers a complete line of coaxial verification kits to confirm a system's performance. All verification kits contain precision components with characteristics traceable to NIST. Verification kits can be kept in a metrology laboratory where they provide the most dependable means of checking system accuracy.



3660 Series Verification Kits

#### 3680 Series Universal Test Fixtures (UTF)

Anritsu's universal test fixture accommodates measurements in microstrip and coplanar waveguide. Spring-loaded jaws help to provide 0.1 dB repeatability on devices from 5 to 75 mils thick. Special fixtures are available for testing packaging transistors. An optional MMIC attachment helps you test integrated circuits.

#### 3670 and 3671 Series Test Port Cables

Anritsu offers laboratory-quality, semi-rigid, and flexible test port cables for K and V connectors.

#### 34 Series Test Port Converters

Test port converters allow you to change the connectors on the VectorStar VNA test ports. Converters are available for K and V connectors.

#### 35 Series Waveguide-to-Coaxial Adapters

These precision waveguide-to-coax adapters transform standard or double-ridge waveguide-to-coaxial K or V connectors.

#### W1 (1.0 mm) Components

Anritsu offers a power divider, power splitter, directional coupler, and a set of 3, 6 and 10 dB attenuators with guaranteed electrical specifications to 110 GHz. These components are metrology-grade and offer the best performance for broadband measurements.

## VectorStar™ MS4640B Vector Network Analyzer Series

### Full-Featured Front Panel for Easy Access to Powerful Functionality

- Access the features and functions of the VectorStar VNA through dedicated keys, touchscreen, and mouse-driven selections
- Input extensive data via your external keyboard
- Custom toolbars provide easy setup configurations for specific measurements
- Select and organize up to 10 icons for fast selection of the most common measurements
- Increase security using the removable SATA hard drive accessible from the rear panel
- Multiple sweep options include: frequency (lin or log) and power, and with option 2, frequency with time gate and time domain (low pass or bandpass)

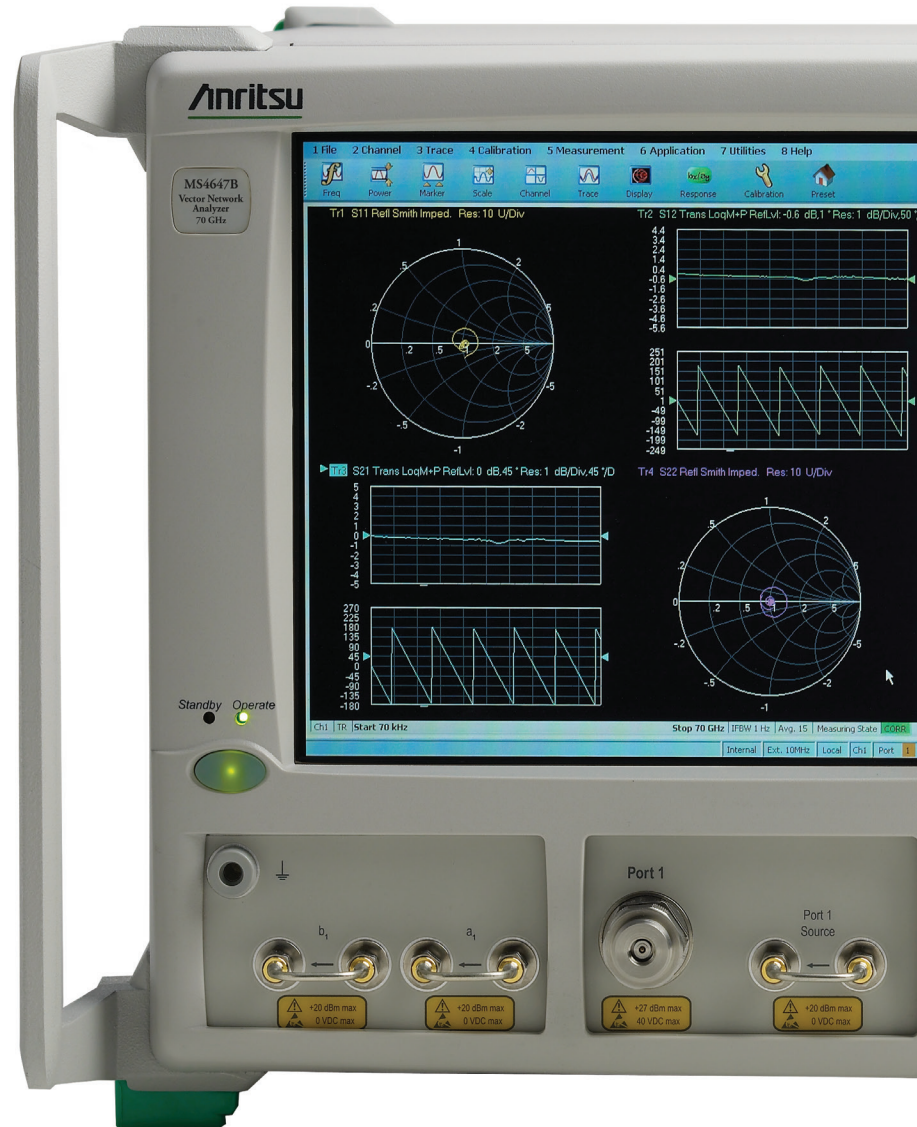

# VectorStar™ MS4640B Vector Network Analyzer Series

## Full-Featured Front Panel for Easy Access to Powerful Functionality

Grouped by category and application, the hard keys provide all the control options dedicated to perform all front panel setups and measurements

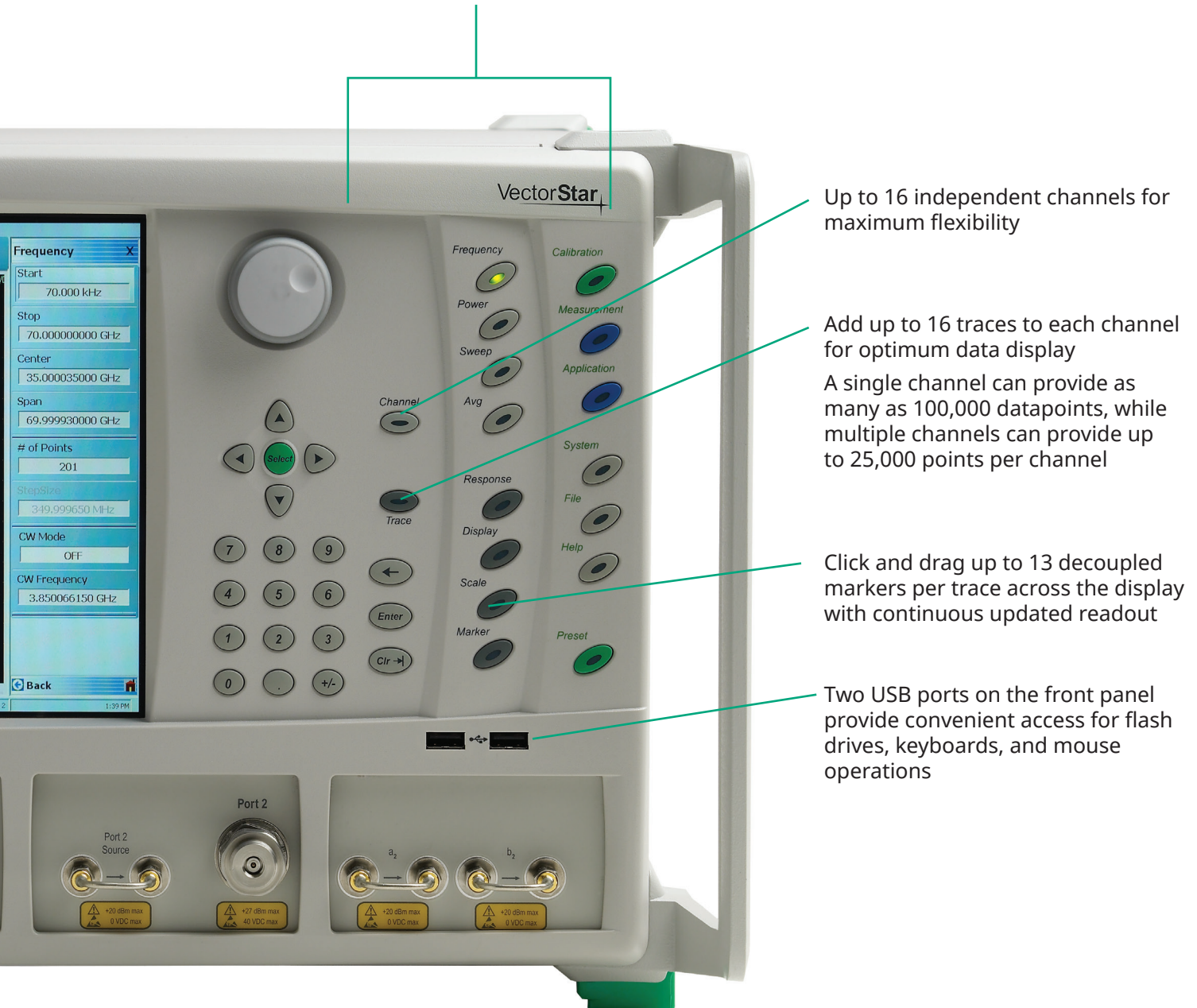

Up to 16 independent channels for maximum flexibility

Add up to 16 traces to each channel for optimum data display  
A single channel can provide as many as 100,000 datapoints, while multiple channels can provide up to 25,000 points per channel

Click and drag up to 13 decoupled markers per trace across the display with continuous updated readout

Two USB ports on the front panel provide convenient access for flash drives, keyboards, and mouse operations

# VectorStar™ MS4640B Vector Network Analyzer Series

## Customizable Rear Panel with Connectivity Options

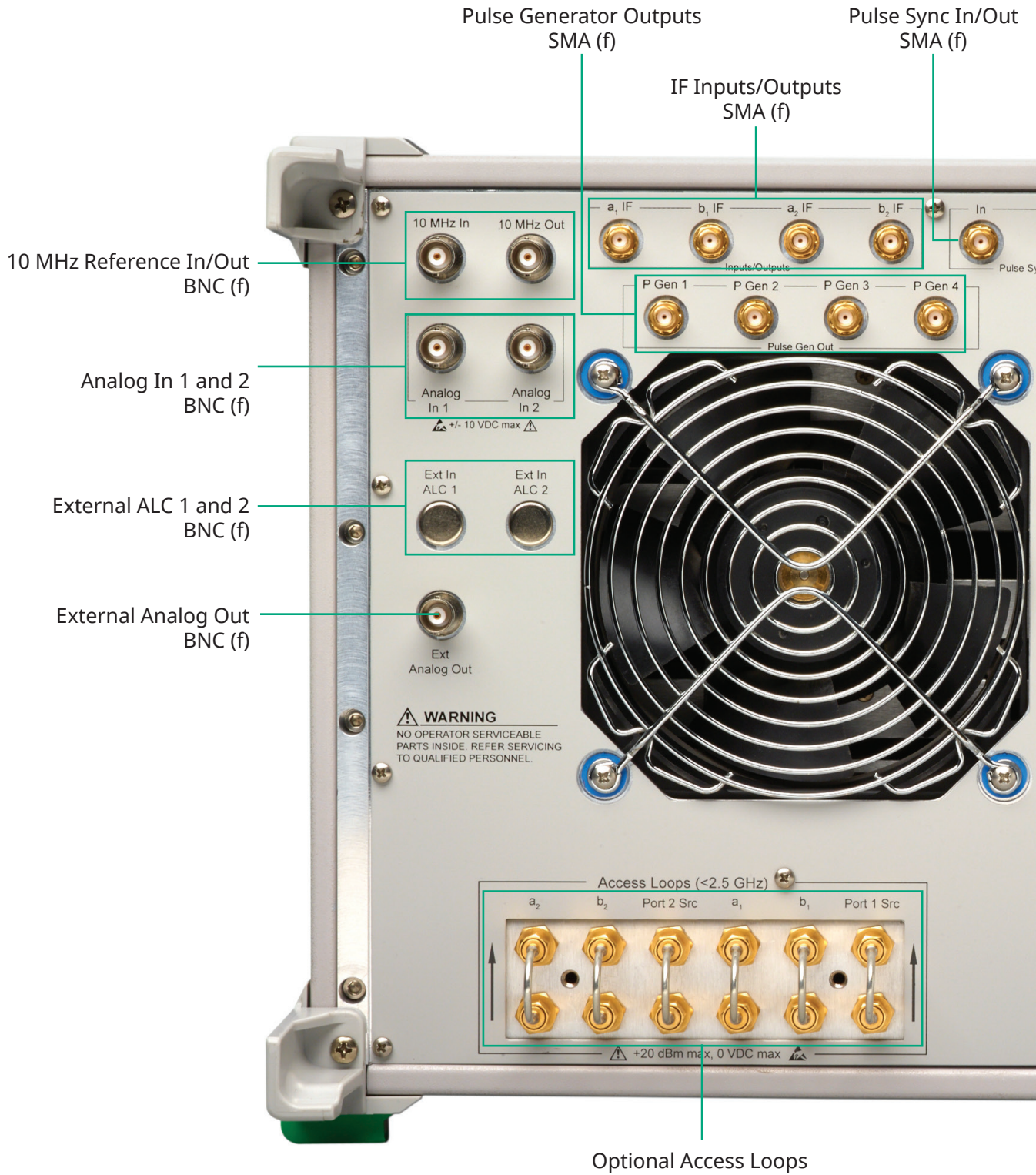

# VectorStar™ MS4640B Vector Network Analyzer Series

## Customizable Rear Panel with Connectivity Options

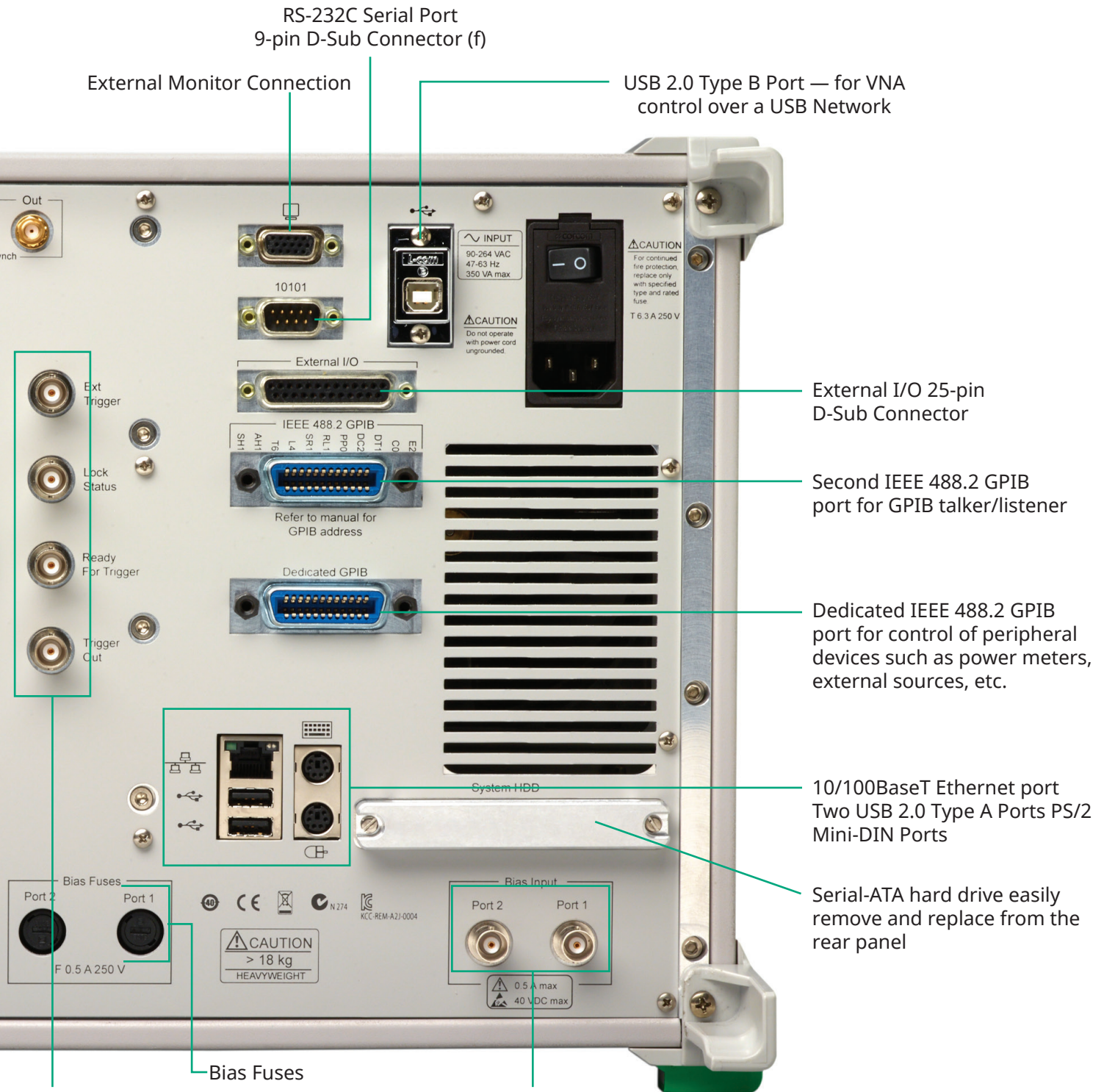

External Trigger - BNC (f)  
 Lock Status - BNC (f)  
 Ready for Trigger - BNC (f)  
 Trigger Out - BNC (f)

Bias Input Ports  
 BNC (f)

## • United States

### **Anritsu Americas Sales Company**

450 Century Parkway, Suite 190, Allen, TX 75013 U.S.A.  
Phone: +1-800-Anritsu (1-800-267-4878)

## • Canada

### **Anritsu Electronics Ltd.**

700 Silver Seven Road, Suite 120, Kanata,  
Ontario K2V 1C3, Canada  
Phone: +1-613-591-2003  
Fax: +1-613-591-1006

## • Brazil

### **Anritsu Eletronica Ltda.**

Praça Amadeu Amaral, 27 - 1 Andar  
01327-010 - Bela Vista - Sao Paulo - SP, Brazil  
Phone: +55-11-3283-2511  
Fax: +55-11-3288-6940

## • Mexico

### **Anritsu Company, S.A. de C.V.**

Blvd Miguel de Cervantes Saavedra #169 Piso 1, Col. Granada  
Mexico, Ciudad de Mexico, 11520, MEXICO  
Phone: +52-55-4169-7104

## • United Kingdom

### **Anritsu EMEA Ltd.**

200 Capability Green, Luton, Bedfordshire, LU1 3LU, U.K.  
Phone: +44-1582-433200  
Fax: +44-1582-731303

## • France

### **Anritsu S.A.**

12 avenue du Québec, Immeuble Goyave,  
91140 VILLEBON SUR YVETTE, France  
Phone: +33-1-60-92-15-50

## • Germany

### **Anritsu GmbH**

Nemetschek Haus, Konrad-Zuse-Platz 1,  
81829 München, Germany  
Phone: +49-89-442308-0  
Fax: +49-89-442308-55

## • Italy

### **Anritsu S.r.l.**

Spaces Eur Arte, Viale dell'Arte 25, 00144 Roma, Italy  
Phone: +39-6-509-9711

## • Sweden

### **Anritsu AB**

Kistagången 20 B, 2 tr, 164 40 Kista, Sweden  
Phone: +46-8-534-707-00

## • Finland

### **Anritsu AB**

Technopolis Aviapolis, Teknobulevardi 3-5 (D208.5),  
FI-01530 Vantaa, Finland  
Phone: +358-20-741-8100

## • Denmark

### **Anritsu A/S**

c/o Regus Winghouse, Ørestads Boulevard 73, 4th floor,  
2300 Copenhagen S, Denmark  
Phone: +45-7211-2200

## • Russia

### **Anritsu EMEA Ltd.**

#### **Representation Office in Russia**

Tverskaya str. 16/2, bld. 1, 7th floor., Moscow, 125009, Russia  
Phone: +7-495-363-1694  
Fax: +7-495-935-8962

## • Spain

### **Anritsu EMEA Ltd.**

#### **Representation Office in Spain**

Paseo de la Castellana, 141. Planta 5, Edificio Cuzco IV  
28046, Madrid, Spain  
Phone: +34-91-572-6761

## • Austria

### **Anritsu EMEA GmbH**

Am Belvedere 10, A-1100 Vienna, Austria  
Phone: +43-(0)1-717-28-710

## • United Arab Emirates

### **Anritsu EMEA Ltd.**

#### **Anritsu A/S**

Office No. 164, Building 17, Dubai Internet City  
P. O. Box – 501901, Dubai, United Arab Emirates  
Phone: +971-4-3758479

## • India

### **Anritsu India Private Limited**

6th Floor, Indiqueb ETA, No.38/4, Adjacent to EMC2,  
Doddanekundi, Outer Ring Road, Bengaluru – 560048, India  
Phone: +91-80-6728-1300  
Fax: +91-80-6728-1301

## • Singapore

### **Anritsu Pte. Ltd.**

11 Chang Charn Road, #04-01, Shriro House, Singapore 159640  
Phone: +65-6282-2400  
Fax: +65-6282-2533

## • Vietnam

### **Anritsu Company Limited**

16th Floor, Peakview Tower, 36 Hoang Cau Street, O Cho Dua Ward,  
Dong Da District, Hanoi, Vietnam  
Phone: +84-24-3201-2730

## • P.R. China (Shanghai)

### **Anritsu (China) Co., Ltd.**

Room 2701-2705, Tower A, New Caohejing International  
Business Center No. 391 Gui Ping Road Shanghai, 200233, P.R. China  
Phone: +86-21-6237-0898  
Fax: +86-21-6237-0899

## • P.R. China (Hong Kong)

### **Anritsu Company Ltd.**

Unit 1006-7, 10/F., Greenfield Tower, Concordia Plaza,  
No. 1 Science Museum Road, Tsim Sha Tsui East,  
Kowloon, Hong Kong, P.R. China  
Phone: +852-2301-4980  
Fax: +852-2301-3545

## • Japan

### **Anritsu Corporation**

8-5, Tamura-cho, Atsugi-shi, Kanagawa, 243-0016 Japan  
Phone: +81-46-296-6509  
Fax: +81-46-225-8352

## • Korea

### **Anritsu Corporation, Ltd.**

5FL, 235 Pangyoyeok-ro, Bundang-gu, Seongnam-si,  
Gyeonggi-do, 13494 Korea  
Phone: +82-31-696-7750  
Fax: +82-31-696-7751

## • Australia

### **Anritsu Pty. Ltd.**

Unit 20, 21-35 Ricketts Road, Mount Waverley, Victoria 3149, Australia  
Phone: +61-3-9558-8177  
Fax: +61-3-9558-8255

## • Taiwan

### **Anritsu Company Inc.**

7F, No. 316, Sec. 1, NeiHu Rd., Taipei 114, Taiwan  
Phone: +886-2-8751-1816  
Fax: +886-2-8751-1817

List Revision Date: 20210610



Anritsu utilizes recycled paper and environmentally conscious inks and toner.



© Anritsu All trademarks are registered trademarks of their respective owners. Data subject to change without notice. For the most recent specifications visit: [www.anritsu.com](http://www.anritsu.com)