



Anritsu envision:ensure

Signal Analyzer

MS2830A

MS2830A-040: 9 kHz to 3.6 GHz

MS2830A-041: 9 kHz to 6 GHz

MS2830A-043: 9 kHz to 13.5 GHz

« MS2830A-044: 9 kHz to 26.5 GHz* »

« MS2830A-045: 9 kHz to 43 GHz* »

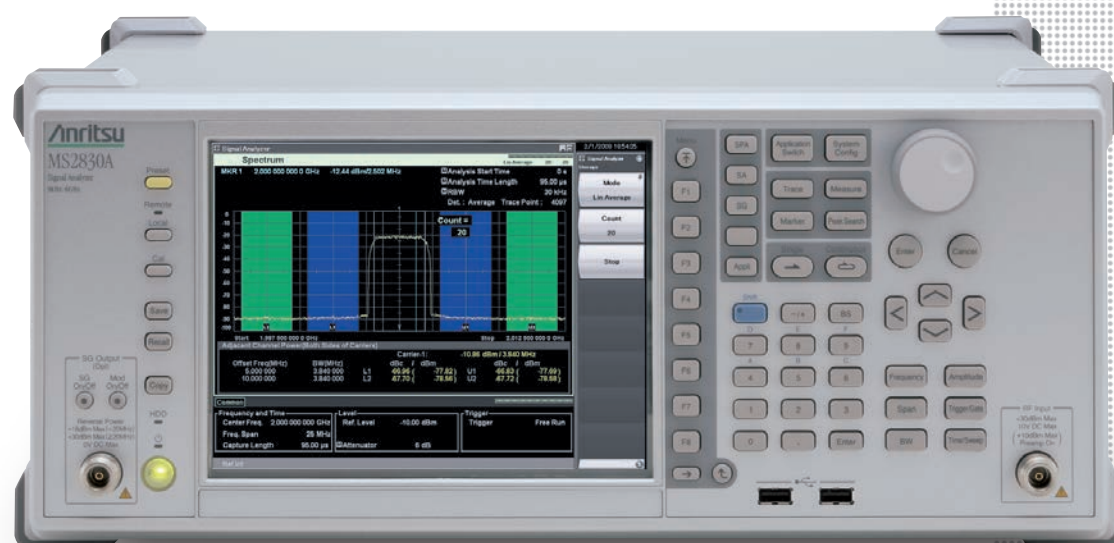

*: See catalog for MS2830A-044/045.



Signal Analyzer MS2830A

The MS2830A is a high-speed, high-performance, cost-effective Spectrum Analyzer/Signal Analyzer.

Not only can it capture wideband signals but FFT technology supports multifunction signal analyses in both the time and frequency domains. Behavior in the time domain that cannot be handled by a sweep type spectrum analyzer can be checked in the frequency domain. A wide frequency can be analyzed using sweep type spectrum analysis functions while detailed signal analysis of a specific frequency band is supported too. Moreover, the built-in signal generator function outputs both continuous wave (CW) and modulated signals for use as a reference signal source when testing Tx characteristics of parts and as a signal source for evaluating Rx characteristics.

Frequency option	MS2830A-040	MS2830A-041	MS2830A-043	MS2830A-044*1	MS2830A-045*1
Frequency range	9 kHz to 3.6 GHz	9 kHz to 6 GHz	9 kHz to 13.5 GHz	9 kHz to 26.5 GHz	9 kHz to 43 GHz
Aging rate	±1 × 10 ⁻⁷ /day (Standard) ±1 × 10 ⁻⁸ /day (MS2830A-002) ±1 × 10 ⁻¹⁰ /month (MS2830A-001)			±1 × 10 ⁻⁸ /day (Standard) ±1 × 10 ⁻¹⁰ /month (MS2830A-001)	
Start time/Characteristics	5 minutes, ±5 × 10 ⁻⁷ (Standard) 5 minutes, ±5 × 10 ⁻⁸ (MS2830A-002) 7 minutes, ±1 × 10 ⁻⁹ (MS2830A-001)			5 minutes, ±5 × 10 ⁻⁸ (Standard) 7 minutes, ±1 × 10 ⁻⁹ (MS2830A-001)	
Phase noise	Frequency: 500 MHz, Spectrum Analyzer mode				
1 kHz offset	-109 dBc/Hz (MS2830A-066)			—	
10 kHz offset	-118 dBc/Hz (MS2830A-066)			—	
100 kHz offset	-115 dBc/Hz (Standard) -133 dBc/Hz (MS2830A-066)			-115 dBc/Hz (Standard)	
1 MHz offset	-133 dBc/Hz (Standard) -148 dBc/Hz (MS2830A-066), nominal			-133 dBc/Hz (Standard)	
Displayed average noise level (DANL)	Spectrum Analyzer mode without options				
Frequency: 500 MHz	—			-153 dBm/Hz	
Frequency: 2 GHz	-151 dBm/Hz			-150 dBm/Hz	
Frequency: 5 GHz	-146 dBm/Hz			-144 dBm/Hz	
Frequency: 12 GHz	-142 dBm/Hz			-151 dBm/Hz	
Frequency: 25 GHz	—			-146 dBm/Hz	
Frequency: 40 GHz	—			-144 dBm/Hz	
Attenuator range/step	0 to 60 dB/2 dB step				0 to 60 dB/10 dB step
Total absolute amplitude accuracy	Unlike normal Total Level Accuracy, this includes frequency characteristics, attenuator switching error and linearity error. Since it gives an instinctive impression of measurement instrument error, it lowers the risk of measurement errors.				
Frequency: 500 MHz, 2 GHz	±0.5 dB			—	
Frequency: 5 GHz, 12 GHz	±1.8 dB			—	
Frequency: 25 GHz	—			±3.0 dB	
Frequency: 40 GHz	—			±3.0 dB	
Resolution bandwidth	1 Hz to 3 MHz (1-3 sequence), 5, 10, 20*8, 31.25 MHz*8, 50 kHz [Spectrum Analyzer mode]				
Analysis bandwidth	10 MHz (MS2830A-006) 31.25 MHz (MS2830A-005) 62.5 MHz (MS2830A-077)*9 125 MHz (MS2830A-078)*9			10 MHz (MS2830A-006) 31.25 MHz (MS2830A-009) 62.5 MHz (MS2830A-077)*9 125 MHz (MS2830A-078)*9	
Additional functions					
Vector signal generator	✓ (MS2830A-020/021)			—	
Low phase noise performance*2	✓ (MS2830A-066)			—	
Phase noise measurement function	—			✓ (MS2830A-010)	
Noise figure measurement function	—			✓ (MS2830A-017)	
BER measurement function	—			✓ (MS2830A-026)	
Preamplifier*3	—			✓ (MS2830A-008)	
Microwave preamplifier*4	—			✓ (MS2830A-068)	
Microwave preselector bypass*5	—			✓ (MS2830A-067)	
External mixer 1st local signal output*6	—			✓ (Standard)	
1st IF signal output*7	—			✓ (Standard)	

*1: See catalog for MS2830A-044/045.

*2: Phase noise improved for <3.6 GHz.

*3: Frequency range: 100 kHz to 3.6 GHz (MS2830A-040)
100 kHz to 6 GHz (excluding MS2830A-040)

*4: Frequency range: 100 kHz to 26.5 GHz (MS2830A-044),
100 kHz to 43 GHz (MS2830A-045)

*5: Frequency range: 4 GHz to 26.5 GHz (MS2830A-044),
4 GHz to 43 GHz (MS2830A-045)

*6: Connector: SMA-J, 50Ω, Local signal: 5 GHz to 10 GHz

*7: Connector: SMA-J, 50Ω, Frequency: 1875 MHz

*8: Can be set when with MS2830A-005. Can not be set when with MS2830A-009.

*9: Signal Analyzer Mode Frequency Setting Range

With MS2830A-077/078, With MS2830A-067, >31.25 MHz bandwidth
300 MHz to 26.5 GHz [MS2830A-044]

300 MHz to 43 GHz [MS2830A-045]

With MS2830A-077/078, Without MS2830A-067, >31.25 MHz bandwidth

300 MHz to 3.6 GHz [MS2830A-040]

300 MHz to 6 GHz [MS2830A-041]

300 MHz to 13.5 GHz [MS2830A-043]

300 MHz to 6 GHz [MS2830A-044]

300 MHz to 6 GHz [MS2830A-045]

Eco-friendly

Anritsu uses two eco product marks indicating environment-friendly products as follows:

Excellent eco product:

80+ score and satisfies excellent eco product requirements

Eco product:

60+ score and satisfies eco product requirements

Resource saving/reduction of manufacturing load
Reduction of toxins
Reduction of logistics load
Reduction of usage load
Reduction of disposal load

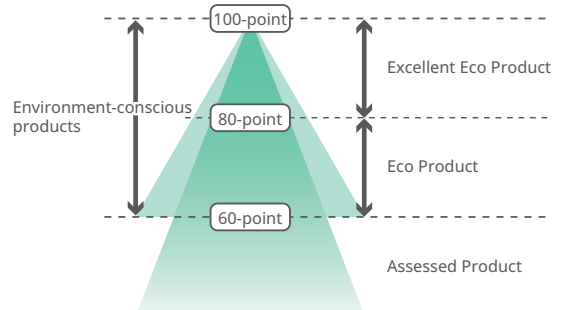

Signal Analyzer MS2830A Key Features

Basic Performance/Functions

Frequency Range

MS2830A-040: 9 kHz to 3.6 GHz
MS2830A-041: 9 kHz to 6.0 GHz
MS2830A-043: 9 kHz to 13.5 GHz

Total Level Accuracy: ± 0.3 dB (typ.)

The Absolute Amplitude Accuracy specification described in catalogs of other spectrum analyzers ignores the important frequency characteristics, linearity, and attenuator switching errors. The MS2830A calibration technology supports excellent level accuracy over the wide frequency range from 300 kHz to 4 GHz even under measurement conditions including the above three errors.

Dynamic Range*1: 168 dB

TOI*2: $\geq +15$ dBm
DANL*3: -153 dBm/Hz

Improved Level Linearity

Internal Reference Oscillator

Pre-installed Reference Oscillator
Aging Rate: $\pm 1 \times 10^{-6}$ /year, $\pm 1 \times 10^{-7}$ /day
Start-up Characteristics: $\pm 5 \times 10^{-7}$ (5 minutes after power-on)
Rubidium Reference Oscillator (MS2830A-001)
Aging Rate: $\pm 1 \times 10^{-10}$ /month
Start-up Characteristics: $\pm 1 \times 10^{-9}$ (7 minutes after power-on)
High Stability Reference Oscillator (MS2830A-002)
Aging Rate: $\pm 1 \times 10^{-7}$ /year, $\pm 1 \times 10^{-8}$ /day
Start-up Characteristics: $\pm 5 \times 10^{-8}$ (5 minutes after power-on)

Versatile Built-in Functions

- Channel Power
- Occupied Bandwidth
- Adjacent Channel Leakage Power
- Spectrum Emission Mask*4
- Spurious Emission*4
- Burst Average Power
- Frequency Counter*4
- AM Depth*5
- FM Deviation*5
- Multi-marker & Marker List
- Highest 10 Markers
- Limit Line*4
- 2-tone 3rd-order Intermodulation Distortion*4
- Annotation Display (On/Off)
- Power Meter*6
- Phase Noise*7
- Noise Figure*8

Low-power-consumption

MS2830A-040: 110 VA (nominal)
MS2830A-041: 110 VA (nominal)
MS2830A-043: 130 VA (nominal)

- *1: Difference between TOI and DANL as simple guide
*2: TOI (Third Order Intercept)
*3: DANL (Displayed Average Noise Level)
*4: Spectrum Analyzer Functions
*5: Signal Analyzer Functions (Requires MS2830A-005/006/077/078)
*6: Power Meter Function (Use USB Power Sensors)
*7: Phase Noise Measurement Function (Requires MS2830A-010)
*8: Noise Figure Measurement Function (Requires MS2830A-017)
[Use Noise Sources (Noisecom, NC346 series)]
*9: Requires MS2830A-006
*10: Requires MS2830A-005 and MS2830A-006
*11: Requires MS2830A-005, MS2830A-006 and MS2830A-077

Signal Analyzer Functions (MS2830A-005/006/077/078)

Analysis Bandwidth

MS2830A-006: 10 MHz max.
(20 MHz max. sampling rate = 50 ns resolution, ADC resolution 16 bits)
MS2830A-005*9: 31.25 MHz max
(50 MHz max. sampling rate = 20 ns resolution, ADC resolution 16 bits)
MS2830A-077*10: 62.5 MHz max.
(100 MHz max. sampling rate = 10 ns resolution, ADC resolution 14 bits)
MS2830A-078*11: 125 MHz max
(200 MHz max. sampling rate = 5 ns resolution, ADC resolution 14 bits)
Note: An image response is received when setting the bandwidth to more than 31.25 MHz. This can be used when not inputting a signal frequency outside the MS2830A analysis bandwidth (125 MHz max.).
The Signal Analyzer series MS2690A/91A/92A is recommended for other measurement purposes.

Capture Function

Saves analysis Span \times Time signal to internal memory and writes to hard disk.

Up to 100 Msamples per measurement can be saved to internal memory.

Example: Span 1 MHz: Max. capture time 50 s
Span 10 MHz: Max. capture time 5 s
Span 100 MHz: Max. capture time 0.5 s

Replay Function

Reads saved data and replays using signal analyzer function.

Examples:

1. Data sharing between separate R&D and manufacturing
2. Later laboratory bench-top analysis of on-site signals

Measurement with Sub-trace Display

Splits screen and confirms both main and sub-traces at same time to check errors.

Main: Spectrum, Frequency vs. Time, Power vs. Time,
Phase vs. Time, CCDF/APD, Spectrogram
Sub: Power vs. Time, Spectrogram

Vector Signal Generator (MS2830A-020/021)

Frequency Range:

MS2830A-020: 250 kHz to 3.6 GHz
MS2830A-021: 250 kHz to 6 GHz

Pre-installed Baseband Generator

Vector Modulation Bandwidth: 120 MHz
Sampling Clock: 20 kHz to 160 MHz

Level Accuracy: ± 0.5 dB (typ.)

Large-capacity Memory:

256 MB = 64 Msamples
1 GB = 256 Msamples (MS2830A-027)

Internal AWGN Generator (MS2830A-028)

BER Measurement Function (MS2830A-026)

This option measures BER using Data/Clock/Enable demodulated at the DUT.

Input Bit Rate: 100 bps to 10 Mbps
Input Level: TTL Level

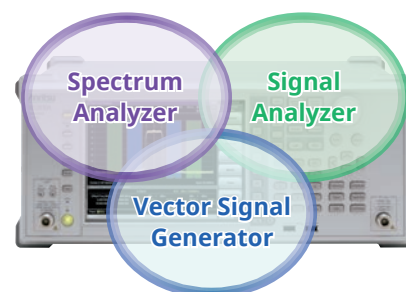

Signal Analyzer MS2830A Panel Layout

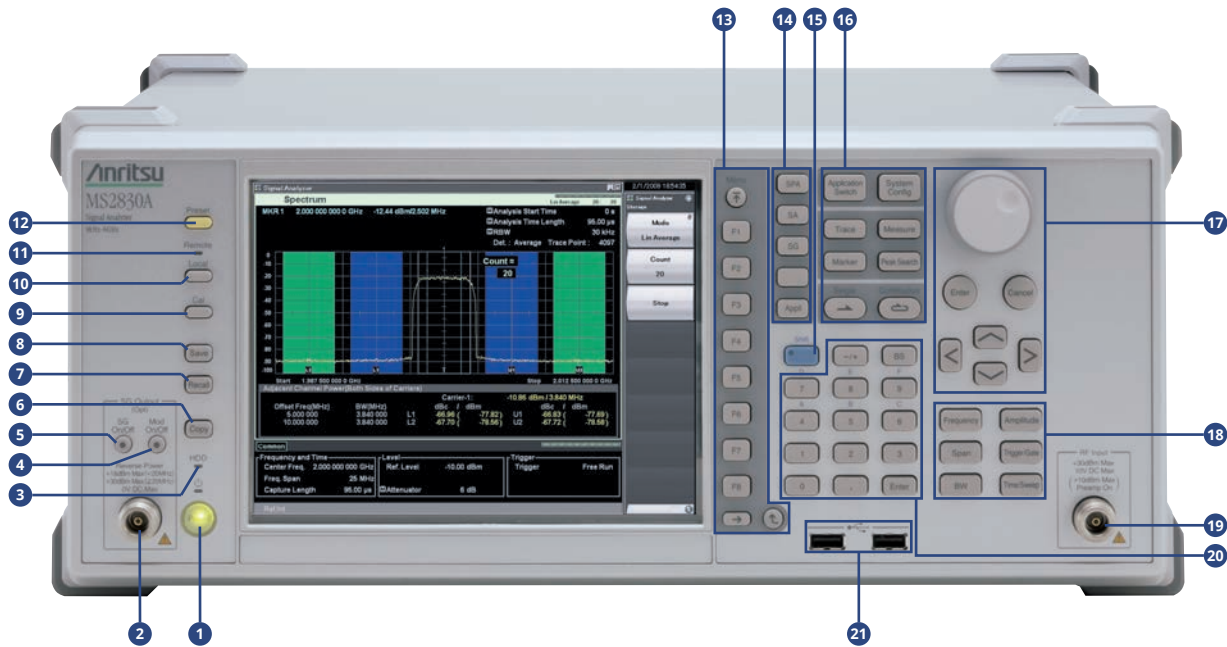

1 Power switch

Press to switch between the standby state in which AC power is supplied and the Power On state in which the MS2830A is under operation. The Power lamp  lights up orange in the standby state, and lights up green in the Power On state. Press the power switch for a reasonably long duration (for about two seconds).

2 SG Output connector

Outputs an RF signal, when the vector signal generator option is installed.

3 HDD lamp

Lights up when the MS2830A internal hard disk is being accessed.

4 Mod On/Off key

When the vector signal generator option is installed, RF signal modulation can be turned on and off by pressing . When modulation is on, the key lamp lights up green.

5 SG On/Off key

If the Vector Signal Generator option is installed, pressing  enables (On) or disables (Off) the RF signal output. The lamp of the RF output control key lights up orange when the RF signal output is set to On.

6 Copy key

Press to capture a screen image from the display and save it to a file.

7 Recall key

Press to recall a parameter file.

8 Save key

Press to save a parameter file.

9 Cal key

Press to display the calibration execution menu.

10 Local key

Press to return to local operation from remote control operation through GPIB, Ethernet or USB (B), and enable panel settings.

11 Remote lamp

Lights up when the MS2830A is in a remote control state.

12 Preset key

Resets parameters to their initial settings.

13 Function keys

Used for selecting or executing function menu displayed on the right of the screen. The function menu contents are provided in multiple pages and layers.

14 Application key

Press to switch between applications.

15 Shift key

Used to operate any keys with functions described in blue characters on the panel. First press the Shift key, then press the target key when the Shift key lamp lights up green.

16 Main function keys 2

Used to set or execute main functions of the MS2830A. Executable functions vary depending on the application currently selected.

17 Rotary knob/Cursor keys/Enter key/Cancel key

The rotary knob and cursor keys are used to select display items or change settings.

18 Main function keys 1

Used to set or execute main functions of the MS2830A. Executable functions vary depending on the application currently selected.

19 RF Input connector

Inputs an RF signal.

20 Numeric keypad

Used to enter numbers on parameter setup screens.

21 USB connector (type A)

Used to connect a USB keyboard or mouse or the USB memory supplied with the MS2830A.

Signal Analyzer MS2830A Panel Layout

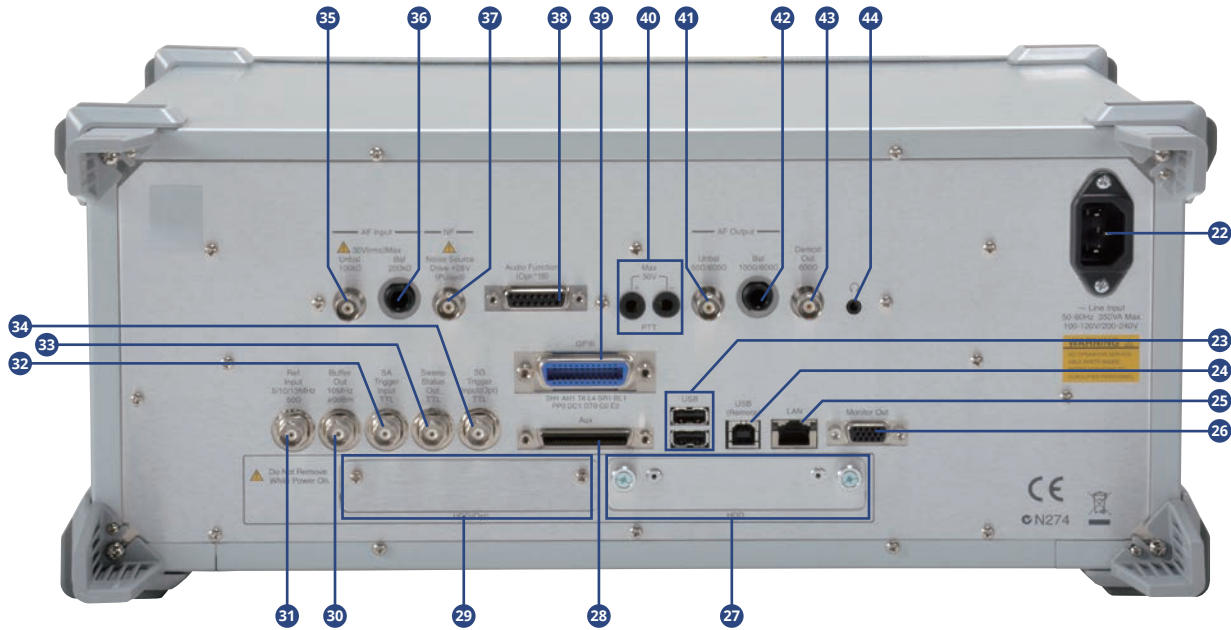

22 AC inlet

Used for supplying power.

23 USB connectors (type A)

Used to connect a USB keyboard or mouse or the USB memory supplied with the MS2830A.

24 USB connector (type B)

Used when controlling the MS2830A externally via USB.

25 LAN (Ethernet) connector

Used for connecting to a personal computer or for Ethernet connection.

26 Monitor Out connector

Used for connection with an external display.

27 HDD slot

This is a hard disk slot.

28 AUX connector

Composite connector for Vector Signal Generator options and BER measurement function options with Marker 1 to 3 outputs, pulse modulation input, baseband reference clock signal input, and BER measurement Clock, Data, and Enable inputs. Converted to BNC using optional AUX Conversion Adaptor (J1556A).

★: The AUX Conversion Adapter J1556A is a standard accessory supplied with the BER Measurement Function MS2830A-026.

29 HDD slot for options

This is a hard disk slot for the options.

30 Buffer Out connector (reference frequency signal output connector)

Outputs the reference frequency signal (10 MHz) generated inside the MS2830A. It is used for synchronizing the frequencies between other devices and the MS2830A based on the reference frequency signal output from this connector.

31 Ref Input connector (reference frequency signal input connector)

Inputs an external reference frequency signal (5/10/13 MHz). It is used for inputting reference frequency signals with accuracy higher than that of those inside the MS2830A, or for synchronizing the frequency of the MS2830A to that of other device.

32 SA Trigger Input connector

This is a BNC connector used to input the external trigger signal (TTL) for the Spectrum Analyzer or Signal Analyzer application.

33 Sweep Status Out connector

Outputs a signal that is enabled when an internal measurement is performed or measurement data is obtained.

34 SG Trigger Input connector

This is a BNC connector used to input the external trigger signal (TTL) for the vector signal generator option.

35 AF Input connector (unbalanced, 100kΩ)

It is a BNC connector for inputting an unbalanced AF signal from an external device.

This is available when MS2830A-018/118 is installed.

36 AF Input connector (balanced, 200kΩ)

It is an 1/4-inch phone jack (3-pole, Φ6.3 mm) connector for inputting a balanced AF signal from an external device.

This is available when MS2830A-018/118 is installed.

37 Noise Source Drive connector

Supply (+28 V) of the Noise Source Drive.

This is available when the MS2830A-017/117 is installed.

38 General Input/Output (Audio Function) connector

It is a D-Sub 15-pin connector for general-purpose input/output from/to an external device.

(Open Collector × 1, TTL output × 2, TTL input × 2)

This is available when MS2830A-018/118 is installed.

39 GPIB connector

Used when controlling the MS2830A externally via GPIB.

40 PTT Control connector

It is a Banana jack to control Push to Talk (PTT).

This is available when MS2830A-018/118 is installed.

41 AF Output connector (unbalanced, 50Ω/600Ω)

It is a BNC connector for outputting an unbalanced AF signal to an external device.

This is available when MS2830A-018/118 is installed.

42 AF Output connector (balanced, 100Ω/600Ω)

It is an 1/4-inch phone jack (3-pole, Φ6.3 mm) connector for outputting a balanced AF signal to an external device.

This is available when MS2830A-018/118 is installed.

43 Demodulation Output connector (600Ω)

It is a BNC connector for outputting a demodulated AF signal to an external device.

This is available when MS2830A-018/118 is installed.

44 Headphone Output connector (Monaural)

It is a 3.5 mm phone jack connector for outputting demodulated AF audio signals to an external device.

This is available when MS2830A-018/118 is installed.

Basic Performance

Excellent Total Level Accuracy: ± 0.3 dB (typ.) (Common to both Spectrum Analyzer and Signal Analyzer Performances)

With a level calibration over a wide frequency range, the MS2830A has excellent total level accuracy.

The Absolute Amplitude Accuracy specification described in catalogs of other spectrum analyzers ignores the important frequency characteristics, linearity, and attenuator switching errors. In contrast, the MS2830A Level Calibration technology assures excellent level accuracy over a wide frequency range from 300 kHz to 4 GHz even under measurement conditions including the above three errors. The level accuracy is assured even when the frequency and attenuator are switched.

The MS2830A total level accuracy includes:

- Frequency characteristics
- Linearity
- Attenuator switching error

Advantage of MS2830A Level Accuracy Technology

Conventional spectrum analyzers perform level calibration at just one frequency point, which causes errors when the frequency changes.

The MS2830A has a built-in calibration oscillator for level calibration over a wide frequency range from 300 kHz to 4 GHz, minimizing measurement errors in this frequency range.

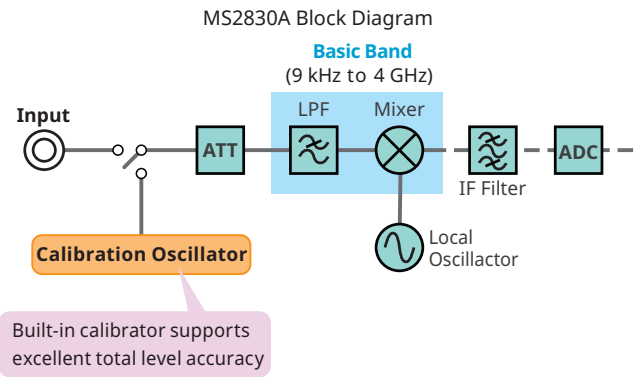

Example: Level Error Comparison with Different Level Calibration Method

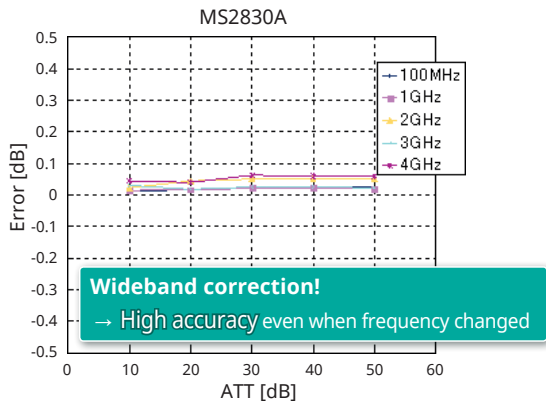

The MS2830A total level accuracy includes:

- Frequency characteristics
- Linearity
- Attenuator switching error

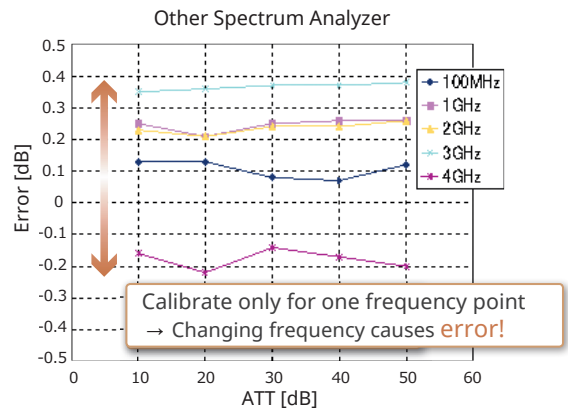

The absolute amplitude accuracy specifications of other spectrum analyzers excludes:

- Frequency characteristics
- Linearity
- Attenuator switching error

Basic Performance

The measuring instrument level error cannot be said to really meet the specifications if measurement requires addition of a margin to the product test specification. Since specifications with added margin are severe, even genuinely passing products may sometimes be evaluated as failing due to this margin.

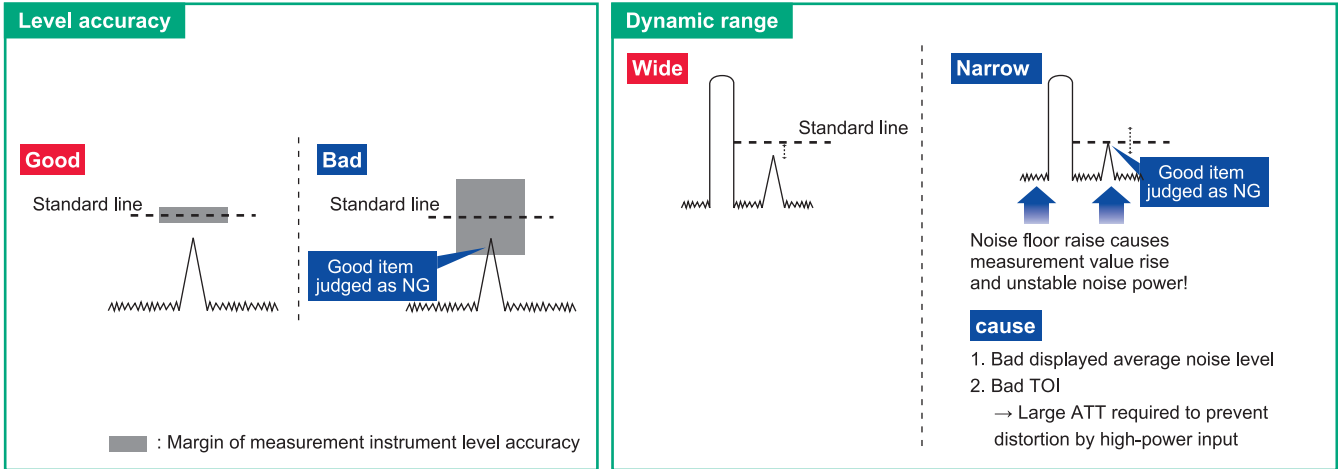

Basic Performance

Wide Dynamic Range

Dynamic Range*¹: 168 dB

TOI*²: $\geq +15$ dBm (300 MHz to 3.5 GHz)

DANL*³: -153 dBm/Hz (30 MHz to 1 GHz)

*1: Difference between TOI and DANL as simple guide.

*2: TOI (Third Order Intercept)

*3: DANL (Displayed Average Noise Level)

Dynamic range is a key specification for spectrum analyzers. Low displayed average noise level (DANL) as well as high TOI are important too. Low TOI may cause distortion with high-level carrier signals. Inserting an attenuator can lower the carrier level but this has the effect of lowering the level of weak spurious, making it hard to measure.

The MS2830A has an excellent dynamic range supporting true performance measurements of devices, such as base stations, requiring wideband measuring instruments.

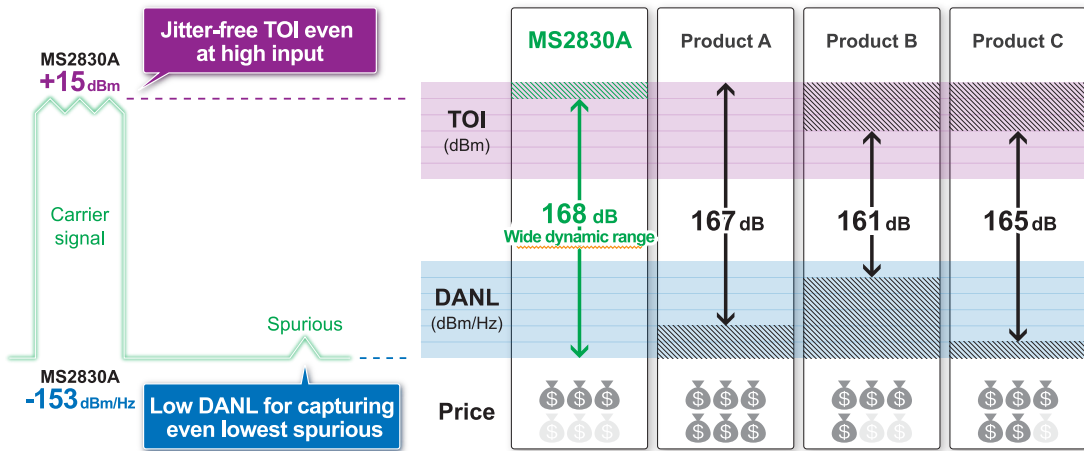

Distortion Characteristics (Spectrum Analyzer)
MS2830A-040/041/043

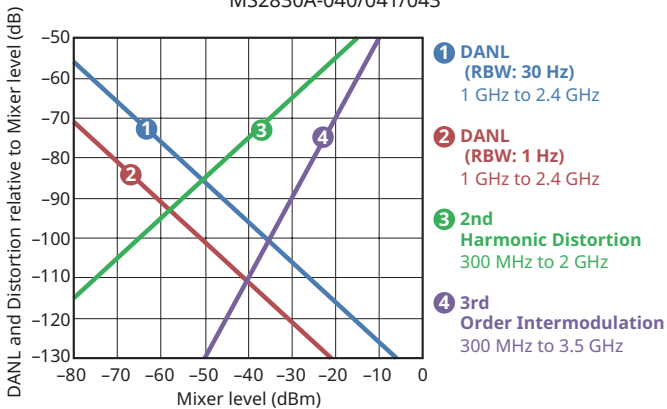

Example: SSB Phase Noise
(Spectrum Analyzer/Signal Analyzer Common)

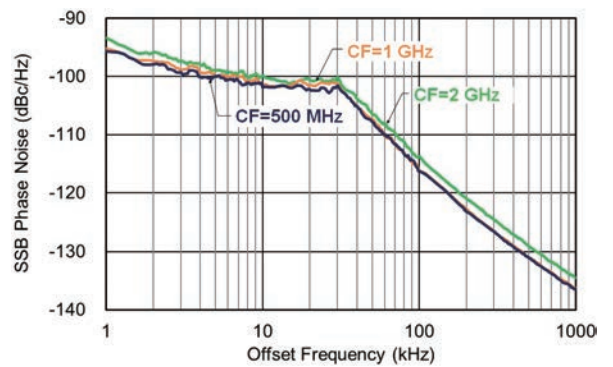

(Applies for instruments with serial number ≥ 6201349078)

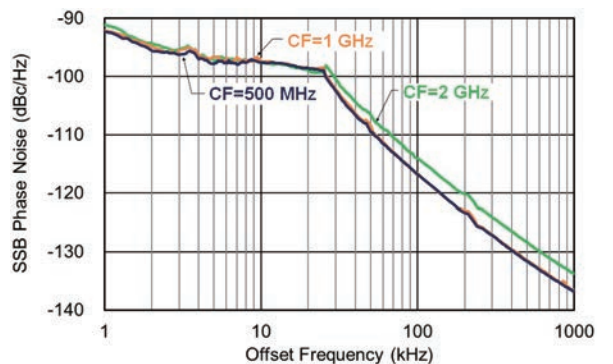

(Applies for instruments with serial number < 6201349078)

Basic Performance

Improved Level Linearity

Conventional spectrum analyzers use an analog IF and log amp to achieve good level accuracy at points near the log scale reference level, but the accuracy degrades at points that are further away. The MS2830A uses a digital IF instead of a log amp, which supports measurements with excellent accuracy at any point.

Example: Level Stability by Switching Reference Level

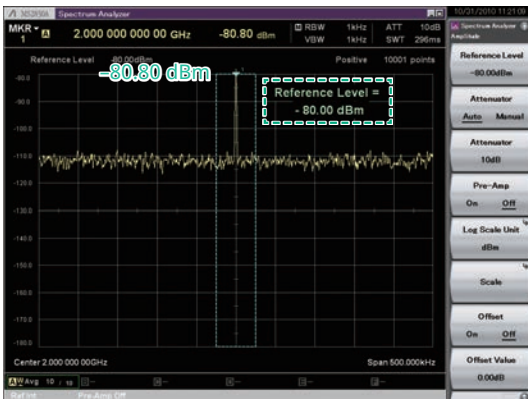
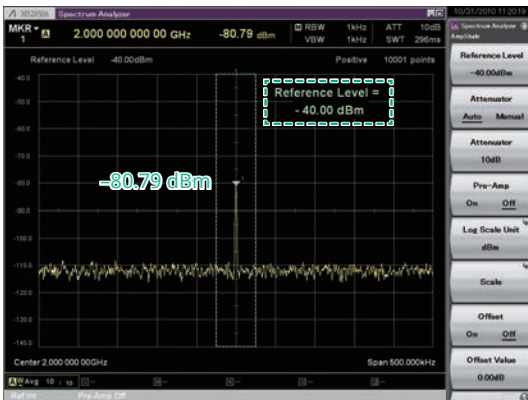

Level Linearity

The MS2830A total level accuracy is better than that of conventional spectrum analyzers but sometimes a power meter is used when wanting to measure with even higher accuracy. However, use of a power meter narrows the dynamic range and errors may also occur easily when switching the power range. Since a power meter has no frequency selection, the total power of the input signal is measured. In other words, the power of the target frequency components cannot be separated out. Measurement can be performed with a wide dynamic range after checking the MS2830A level measurement reference value with a power meter.

The MS2830A total level accuracy includes:

- Frequency characteristics
- Linearity
- Attenuator switching error

And supports excellent:

- Log scale stability

Dual Sweep Speed: Normal/Fast

When sweep time is set to [Auto], Normal (normal sweep) or Fast mode (high-speed sweep) can be set. The Fast mode sweeps six times faster than the Normal mode.

Example of Sweep Mode Switch Error: (CW -10 dBm input)
Level Error when Switching from Normal to Fast

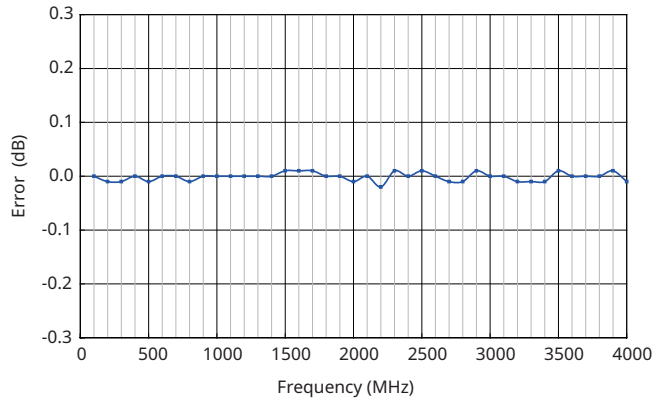

Basic Performance

Low Consumption Power, Excellent Eco Product

The MS2830A meets Anritsu "Excellent eco products" standard for environment-friendly products. It cuts consumed power by 50% compared to conventional models.

Power Consumption:

- ≤350 VA (including all options)
- 110 VA (nominal, with MS2830A-040, 3.6 GHz*1)
- 110 VA (nominal, with MS2830A-041, 6 GHz*1)
- 130 VA (nominal, with MS2830A-043, 13.5 GHz*1)

*1: One of the MS2830A-040, 041 or 043. Excludes other options.

Resolution Bandwidth (RBW)

Setting Range

Spectrum Analyzer:

- 1 Hz to 3 MHz (1-3 sequence),
- 500 Hz, 50 kHz, 2 MHz, 5 MHz, 10 MHz, 20 MHz*2, 31.25 MHz*2, *3,
- 200 Hz (6 dB)*4, 9 kHz (6 dB)*4, 120 kHz (6 dB)*4,
- 1 MHz (Impulse)*4

Spectrum trace in signal analyzer mode:

- 1 Hz to 1 MHz (1-3 sequence)*5
- 1 Hz to 3 MHz (1-3 sequence)*6
- 1 Hz to 10 MHz (1-3 sequence)*7

When monitoring two adjacent signals, the frequency resolution can be increased by reducing the resolution bandwidth (RBW).

This also has the effect of reducing the noise level.

Conversely, to confirm level variations of 20-MHz band signals such as LTE, set the RBW to 31.25 MHz.

*2: Can be set when with MS2830A-005.

*3: Instead of Gaussian filter, 31.25 MHz RBW uses filter with flat top characteristics above 31.25 MHz.

*4: When MS2830A-016 installed.

*5: Without MS2830A-077/078, or Bandwidth: ≤31.25 MHz.

*6: With MS2830A-077, Bandwidth: >31.25 MHz.

*7: With MS2830A-078, Bandwidth: >31.25 MHz.

Gate Sweep

Gate sweep executes sweeping only for the length of time specified by the gate length, starting from when the trigger condition is met. A delay time until sweeping starts after the trigger condition is met can be set using trigger delay.

- The gate source can be selected from the following
 - Wide IF video trigger
 - External trigger
 - Frame trigger
 - SG marker trigger (Requires MS2830A-020/021)
- Setting range and resolution for gate delay
 - Setting range: 0 to 1 s
 - Resolution: 20 ns
- Setting range and resolution for gate length
 - Setting range: 50 μs to 1 s
 - Resolution: 20 ns

Trigger Function

Trigger sweep executes sweeping using the specified trigger condition as the start point. In particular, "SG Marker" starts analyzer measurement in synchrony with the signal output by installing MS2830A-020/021. Using this function supports simple synchronized measurement even when evaluating signals with large level variation over time, such as modulation signals.

- Video trigger:
 - Trigger sweeping starts in synchronization with the rise or fall of the waveform. A trigger level indicator showing the trigger level is displayed on the screen.
- Wide IF video trigger:
 - An IF signal with a wide passing band of about 5 MHz is detected, and sweeping starts in synchronization with either the rise or fall of the detected signal.
- External trigger:
 - Sweeping starts in synchronization with the rise or fall of the signal input via the Trigger Input connector.
- Frame trigger:
 - An equipment-internal trigger signal is used to generate a trigger and start the sweep. The generation period (Period) and offset time (Offset) for the trigger signal can be set. It is also possible to re-synchronize the trigger signal with either the Wide IF Video signal or an external trigger.
- SG Marker trigger (Requires MS2830A-020/021):
 - Sweeping starts in synchronization with the rise or fall of the marker signal output of MS2830A-020/021. This function supports measurement in synchronization with the output signal of MS2830A-020/021.

Three Built-in External Interfaces

The built-in Gigabit Ethernet, USB2.0, and GPIB interfaces support remote operation.

GPIB: IEEE488.2, Rear panel, IEEE488 bus connector

Interface functions: SH1, AH1, T6, L4, SR1, RL1, PP0, DC1, DT0, C0, E2

Ethernet: 10/100/1000BASE-T, Rear panel, RJ-45

USB (B): USB2.0, Rear panel, USB-B connector

Saving Measurement Results

Measurement results can be saved to internal hard disk or external USB memory. Screen dumps and trace data can be saved too.

- Screen dump file type
 - BMP
 - PNG
- The color of the screen hard copy can be set as follows:
 - Normal (same as screen display)
 - Reverse
 - Monochrome
 - Reversed Monochrome

Signal Analyzer: Basic Performance/Functions

Wide bandwidth × High Accuracy FFT Analysis

- MS2830A-006: 10 MHz max.
- (20 MHz max. sampling rate = 50 ns resolution, ADC resolution 16 bits)
- MS2830A-005*1: 31.25 MHz max.
- (50 MHz max. sampling rate = 20 ns resolution, ADC resolution 16 bits)
- MS2830A-077*2: 62.5 MHz max.
- (100 MHz max. sampling rate = 10 ns resolution, ADC resolution 14 bits)
- MS2830A-078*3: 125 MHz max.
- (200 MHz max. sampling rate = 5 ns resolution, ADC resolution 14 bits)

Note: An image response is received when setting the bandwidth to more than 31.25 MHz. This can be used when not inputting a signal frequency outside the MS2830A analysis bandwidth (125 MHz max.). The Signal Analyzer series MS2690A/91A/92A is recommended for other measurement purposes.

Based on the excellent level accuracy and wide dynamic range of the MS2830A, a signal with an FFT analysis bandwidth of up to 125 MHz can be captured with a level accuracy of ± 0.3 dB.

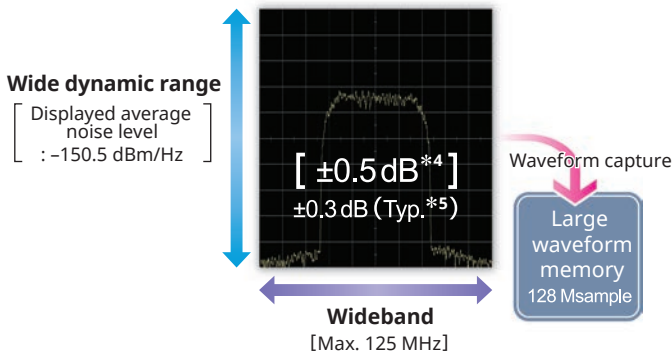

- *1: Requires MS2830A-006.
- *2: Requires MS2830A-005 and MS2830A-006.
- *3: Requires MS2830A-005, MS2830A-006 and MS2830A-077.
- *4: $300 \text{ kHz} \leq f < 4 \text{ GHz}$, Frequency band mode Normal.
- *5: Excluding Guard Band.

Vector Signal Analysis (VSA) Function

Seamless signal capture and VSA analysis in multiple domains make it easy to evaluate burst-signal responses and capture degraded spectrum transients, etc., which cannot be checked by conventional sweep spectrum analyzers. This greatly improves design verification and troubleshooting efficiency.

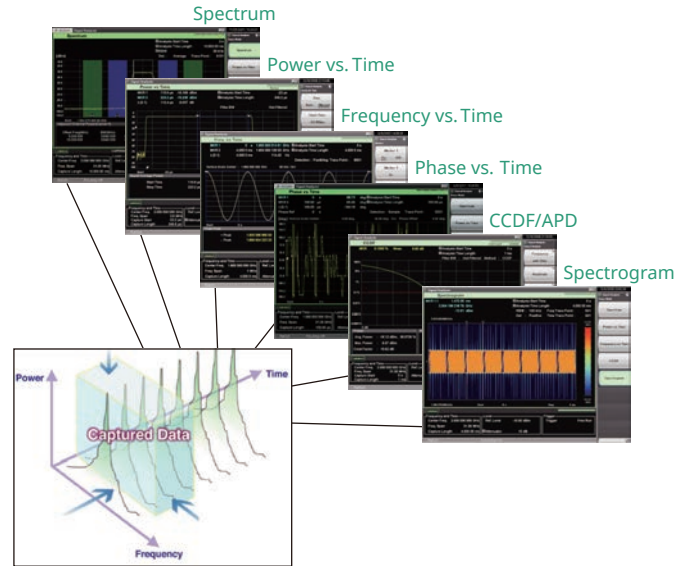

Signal Analyzer: Basic Performance/Functions

Save Signals in Internal Memory

Max. Capture Time: 0.5 s to 2000 s
 Max. Number of Samples: 100 Msamples

The “Analysis bandwidth × Analysis time” signal is held in internal memory and saved to hard disk.
 Up to 100 Msamples of data can be saved to memory for one measurement. The frequency span determines the sampling rate. The following chart shows the maximum capture time per frequency span.

Span*	Sampling Rate	Capture Time	Max. Sampling Data
1 kHz	2 kHz	2000 s	4M
2.5 kHz	5 kHz	2000 s	10M
5 kHz	10 kHz	2000 s	20M
10 kHz	20 kHz	2000 s	40M
25 kHz	50 kHz	2000 s	100M
50 kHz	100 kHz	1000 s	100M
100 kHz	200 kHz	500 s	100M
250 kHz	500 kHz	200 s	100M
500 kHz	1 MHz	100 s	100M
1 MHz	2 MHz	50 s	100M
2.5 MHz	5 MHz	20 s	100M
5 MHz	10 MHz	10 s	100M
10 MHz	20 MHz	5 s	100M
25 MHz	50 MHz	2 s	100M
31.25 MHz	50 MHz	2 s	100M
50 MHz	100 MHz	500 ms	50M
62.5 MHz	100 MHz	500 ms	50M
100 MHz	200 MHz	500 ms	100M
125 MHz	200 MHz	500 ms	100M

*: With MS2830A-006: 1 kHz to 10 MHz
 With MS2830A-005/006: 1 kHz to 31.25 MHz
 With MS2830A-005/006/077: 1 kHz to 62.5 MHz
 With MS2830A-005/006/077/078: 1 kHz to 125 MHz

Replay Function for Comparison Evaluation

This function reads saved data and replays it using the signal analyzer measurement function.

Examples:

1. Data sharing between separate R&D and manufacturing
2. Later laboratory bench-top analysis of on-site signals
3. Save data at shipment and re-verify if problem occurs

Captured Waveform Data: Selection Screen

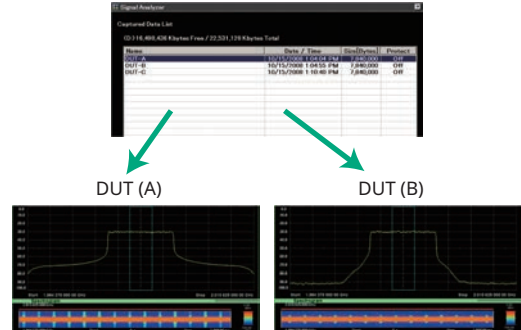

Signal Analyzer: Trace

Spectrum

The Spectrum trace displays a graph with amplitude on the y-axis and frequency on the x-axis. The captured IQ data is FFT processed (fast Fourier transformed) and converted from the time domain to the frequency domain for display as a spectrum.

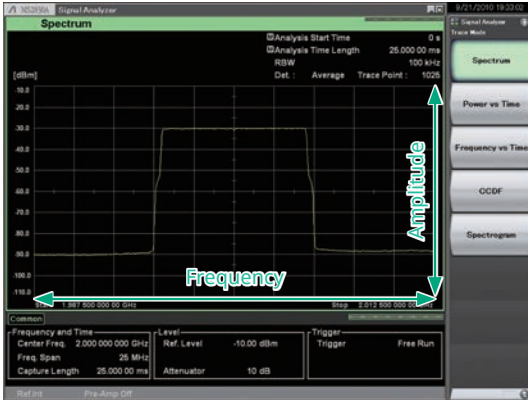

Power vs. Time

The Power vs. Time trace displays a graph with amplitude on the y-axis and time on the x-axis to confirm changes in power with time of measured signals.

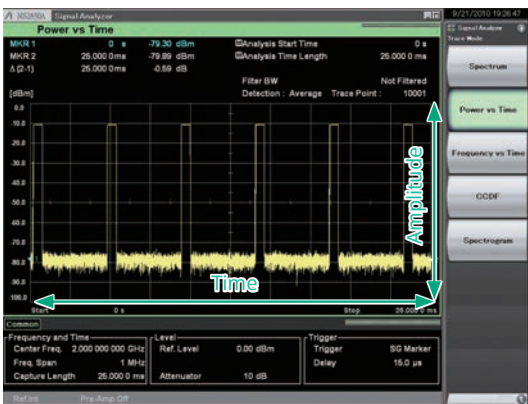

Frequency vs. Time

The Frequency vs. Time trace displays a graph with frequency on the y-axis and time on the x-axis to confirm time variation of the measured signal frequency.

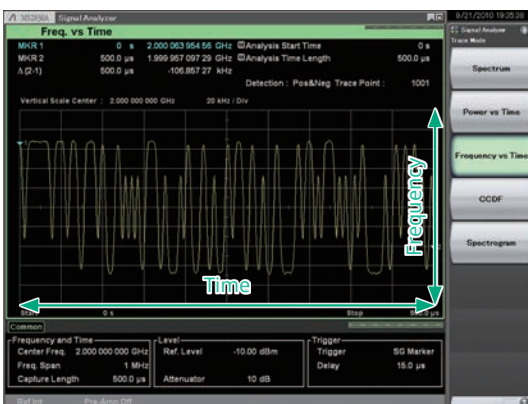

Phase vs. Time

The Phase vs. Time trace displays a graph with phase on the y-axis and time on the x-axis to confirm time variation of the measured signal phase.

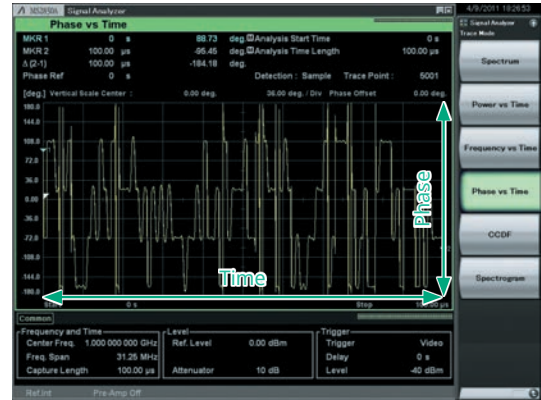

CCDF*1/APD*2

The CCDF trace displays the power variation probability on the y-axis and power variation on the x-axis to confirm the CCDF and APD of measured signals.

- *1: CCDF (Complementary Cumulative Distribution Function)
- *2: APD (Amplitude Probability Density)



Measurement Results

- CCDF: The CCDF display indicates the cumulative distribution of transient power variations compared to average power.
- APD: The APD display indicates the probability distribution of transient power fluctuations compared to average power.

Signal Analyzer: Trace

Spectrogram

The Spectrogram trace displays the level as color with frequency on the y-axis and time on the x-axis. The captured IQ data is FFT processed to confirm time variations in the continuous spectrum. It is useful for monitoring frequency hopping and transient signals.

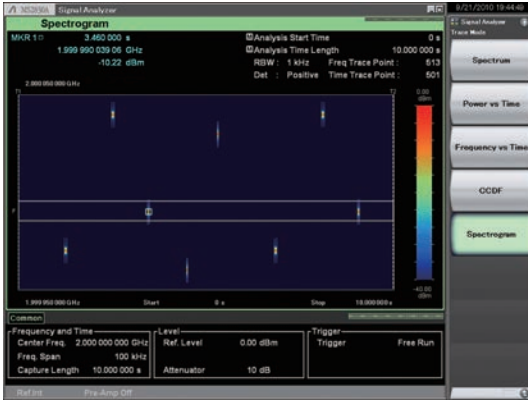

No Trace

No Trace mode does not execute signal analysis. Therefore, "IQ data output" and "IQ data readout using remote commands" can be executed quickly without the need to wait for completion of analysis.



Measurement with Sub-trace Display

This function splits the screen into top and bottom halves; simultaneous display of the sub-trace supports easy monitoring of fault locations and transient phenomena.

- Main: Spectrum, Frequency vs. Time, Power vs. Time, Phase vs. Time, CCDF/APD, Spectrogram
- Sub: Power vs. Time, Spectrogram

The part of a previously captured long-term signal to be monitored can be selected (red part) on the sub-trace to display the problem part only on the main trace.

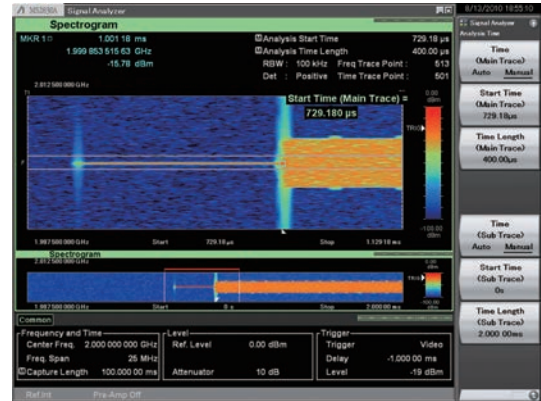

Example: Sub-trace Display

Confirm analysis range in sub-trace, and target signal status on main trace.

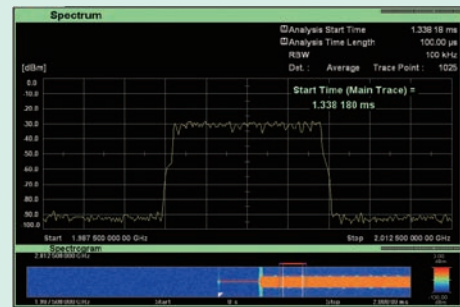
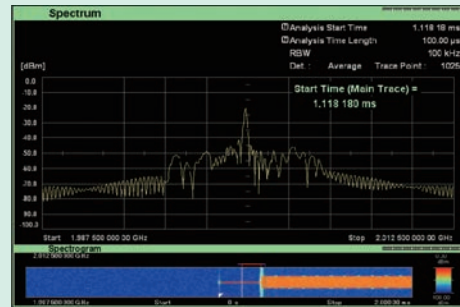

↑ Analysis range

Signal Analyzer: Applications

Analyze Captured Waveforms using Third-Party Tools

The MS2830A utilizes proprietary calibration technologies, enabling digitized baseband data to be used directly in third-party analysis tools without the need for correction.

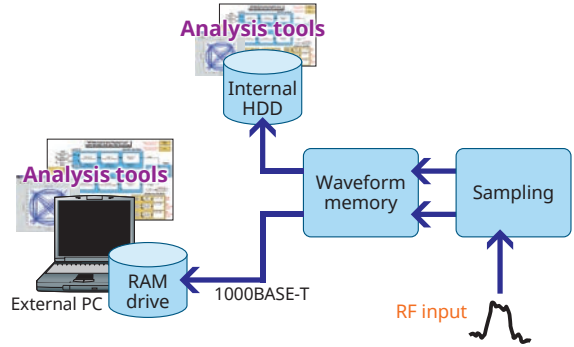

Capture & Playback Real-World Signals

The MS2830A provides *Capture & Playback* functionality that enables laboratory-grade testing of transceiver systems using real world signals. Using the optional integrated Vector Signal Analyzer and Vector Signal Generator of the MS2830A, *Capture & Playback* allows users to conveniently capture up to 100 MHz of spectrum and play it back at any designated frequency and amplitude, making it easy to determine device performance margins.

Applications for Capture & Playback

Validation/Production Test

Captured signals can be used to initiate a communications link and perform receiver sensitivity testing with a device under test (DUT) using signals captured from a Golden Unit.

Device Characterization

Actual baseband signals captured from an RFIC can be used as simulation for characterizing amplifiers and other downstream devices or modules.

Electromagnetic Compatibility Test

Problematic RF environments or discrete signals – such as cellular or Wi-Fi – can be captured and used to evaluate a device’s susceptibility to RF interference, debug any problems found and validate the solution



Repeatably Test Device Performance using “Real-World” RF Environments

Capture output signal from “Golden Unit”

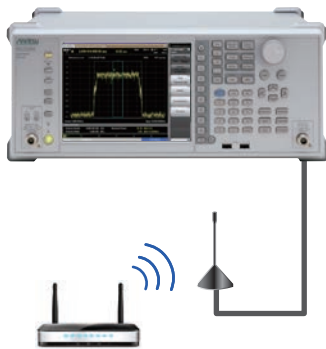

Playback “Golden Unit” signal with stability and repeatability

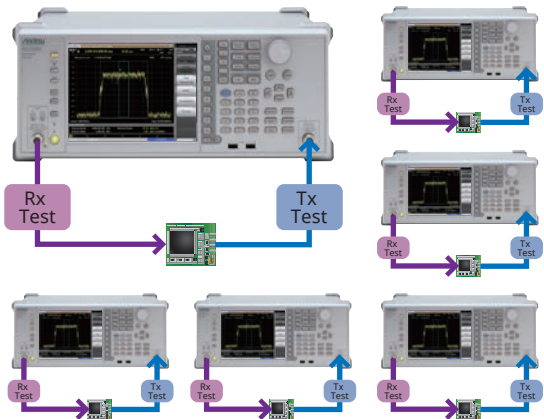

Use “Golden Unit” Signal for Manufacturing Test and Calibration

Wi-Fi® is a registered trademark of Wi-Fi Alliance.

Signal Analyzer: Applications

Capture & Playback Highlights

Bandwidth and Time Limits

- Minimum 10 kHz Bandwidth (2000 s maximum duration)*
- Maximum 100 MHz Bandwidth (500 ms maximum duration)*
- *: Maximum bandwidth depends upon vector signal analyzer options installed (MS2830A-006/005/077/078). Maximum playback duration depends upon whether vector signal generator memory upgrade (MS2830A-027) is installed.

Captured signal may be freely tuned to any output frequency and amplitude supported by the vector signal generator.

Any section of the captured waveform record may be selected and played back.

- ✓ Enables user to isolate and reproduce specific signal bursts
- ✓ Enables user to change duty cycle of pulsed waveforms

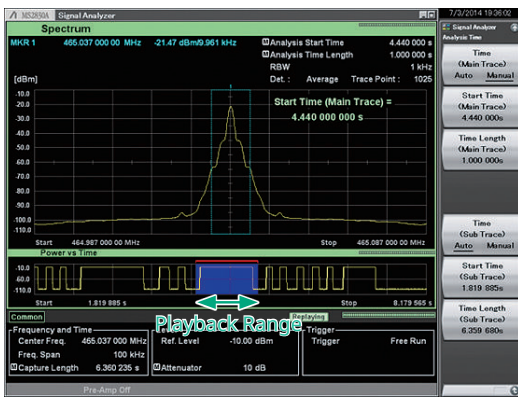
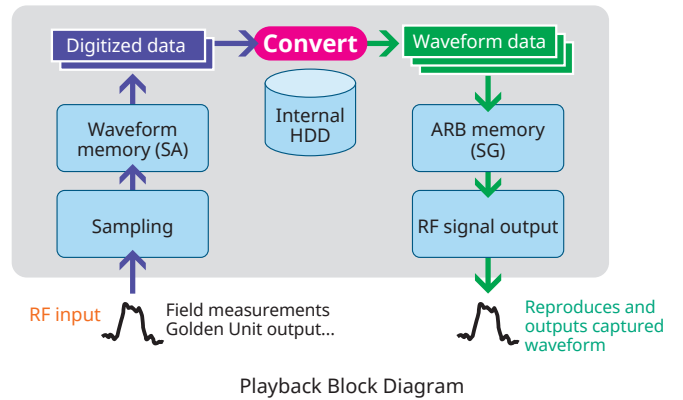

Playback any Desired Section of Captured Waveform

Versatile Built-in Functions

Useful for Tx Characteristics Evaluation

The MS2830A is fully loaded with all the functions required for evaluating Tx characteristics. Tests can be performed simply and in accordance with standards using functions tailored to measurement contents.

Measure Function	SPA*1	VSA*2
Channel Power	✓	✓
Occupied Bandwidth	✓	✓
Adjacent Channel Leakage Power	✓	✓
Spectrum Emission Mask	✓	
Burst Average Power	✓	✓
Spurious Emission	✓	
AM Depth		✓
FM Deviation		✓
Multi-marker & Marker List	✓	✓
Highest 10 Markers	✓	✓
Limit Line	✓	
Frequency Counter	✓	
2-tone 3rd-order Intermodulation Distortion	✓	
Annotation Display (On/Off)	✓	
Power Meter	Independent function*3	
Phase Noise	MS2830A-010	
Noise Figure	MS2830A-017*4	

- *1: SPA (Spectrum Analyzer)
- *2: VSA (Vector Signal Analyzer), Requires MS2830A-005/006/077/078
- *3: Use USB Power Sensors
- *4: Use Noise Sources (Noisecom, NC346 series)

Channel Power

This function measures channel bandwidth power. Three types of filters (Rect, Nyquist, Root Nyquist) can be selected. Pre-installed templates for each standard support easy parameter setting.

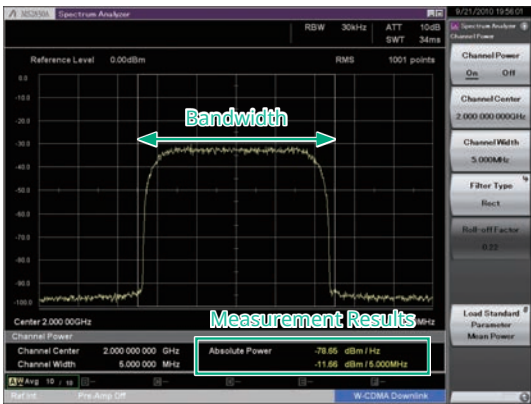

- Measurement Results
- Absolute power per Hz in channel band
 - Total power in channel band

Occupied Bandwidth

Occupied bandwidth is measured by selecting either the N% or X-dB mode. Pre-installed templates for each standard support easy parameter setting.

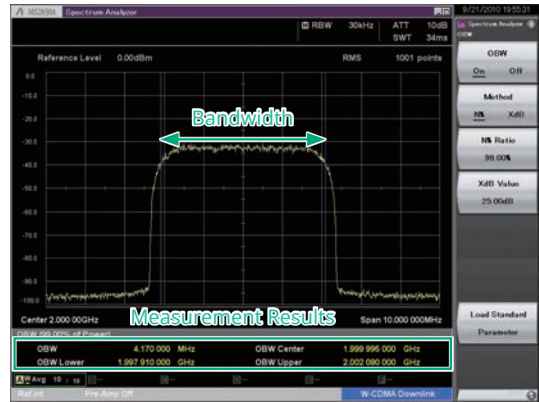

- Measurement Results
- Bandwidth for specified conditions

Adjacent Channel Leakage Power

This function measures carrier adjacent channel (offset) power (In-Band). 1 to 12 carriers can be set and switched instantaneously on-screen. True ACLR performance is measured using the noise cancellation function to subtract main-frame noise from the measurement result. Pre-installed templates for each standard support easy parameter setting.



- Measurement Results
- Absolute power of Offset channel
 - Relative values in relation to reference power selected in ACP reference

Versatile Built-in Functions

Spectrum Emission Mask

(SPA)

This function splits the offset part into up to 12 segments; the measurement parameters and limit lines can be specified to measure the peak power and margin for each segment. The results are tabulated below the trace and marked PASS/FAIL. Pre-installed templates for each standard support easy parameter setting.

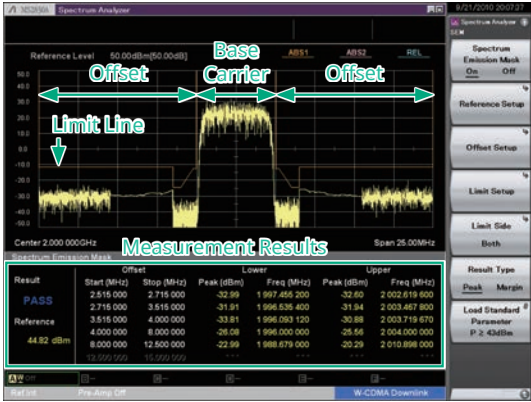

- Measurement Results
- Peak power (or margin) at offset
 - Each peak frequency

Spurious Emission

(SPA)

This function splits the frequency range into up to 20 segments for sweeping; the measurement parameters and limit lines can be specified to measure the peak power and margin for each segment. The results are tabulated below the trace and marked PASS/FAIL. In particular, all tests can be completed up to the final stage without an external PC because the zero-span capture function described in the technology compliance test is built-in.

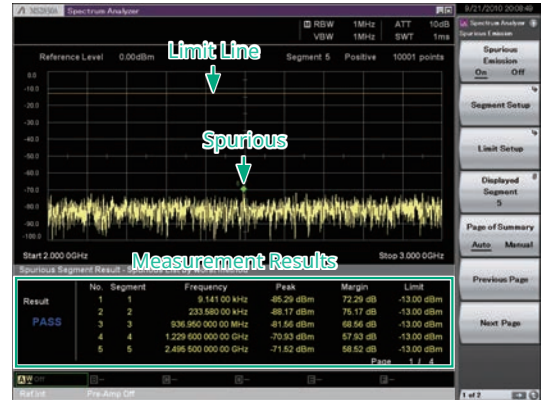

- Measurement Results
- Each segment peak power and margin
 - Each peak frequency

Burst Average Power

(SPA) (VSA)

The average power for the range specified by two markers is displayed in the time domain. Measurement only requires setting the measurement start and stop positions on the screen. True performance is measured using the noise cancellation function to subtract main-frame noise from the measurement result. Pre-installed templates for each standard support easy parameter setting.

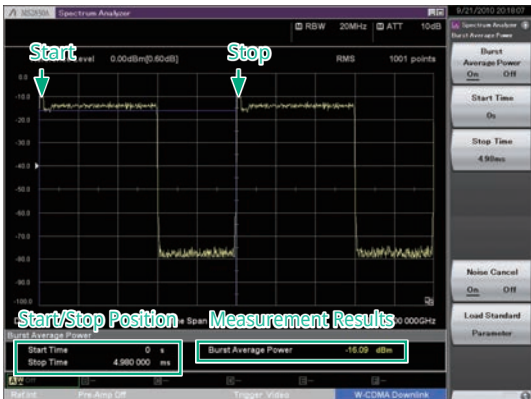

- Measurement Results
- Average power of specified range

Example: Spurious Emission

The Japanese Radio Law governing measurement of spurious specifies searching for the peak level in the swept frequency segment using different parameter settings and then performing zero-span measurement of the found peak point. The MS2830A spurious measurement function not only performs the sweep search but also performs the zero-span measurement automatically as well, and displays the results of both. Using zero-span measurement, the search screen is displayed as is while zero-span measurement runs in the background and the result markers are plotted on the search screen. Time wasted by screen switching is reduced and the correlation with the search results can be seen at a glance.

Measurement Example

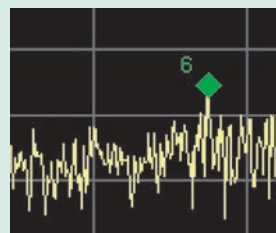

Search only



Search + Measurement

Versatile Built-in Functions

AM Depth (VSA)

The Power vs. Time trace measurement function is used to confirm AM depth. It measures the measured signal AM based on trace data at the displayed marker. When marker is Off, the whole range is measured.

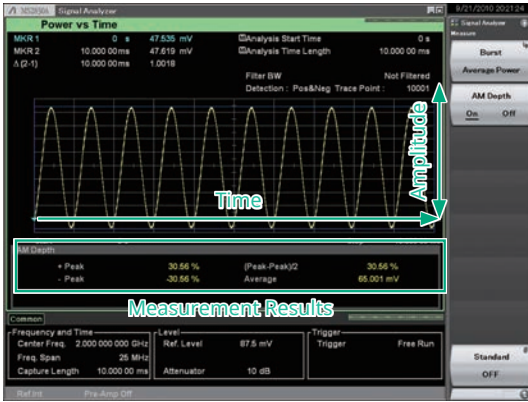

Measurement Results

- +Peak, -Peak, (Peak-Peak)/2, Average

FM Deviation (VSA)

The Frequency vs. Time trace measurement is used to confirm the FM deviation. It measures the maximum and minimum frequencies from trace data in the marker range. When marker is Off, the whole range is measured.



Measurement Results

- +Peak, -Peak, (Peak-Peak)/2, Average

Multi-marker & Marker List (SPA) (VSA)

Up to 10 markers can be set for this function. Markers may be either a spot or a zone. Using a zone marker, the peak of a signal with an unstable variable frequency can be tracked and measured. Not only can the 10 markers be listed below the trace but the differences between markers can be calculated and displayed using the delta setting.

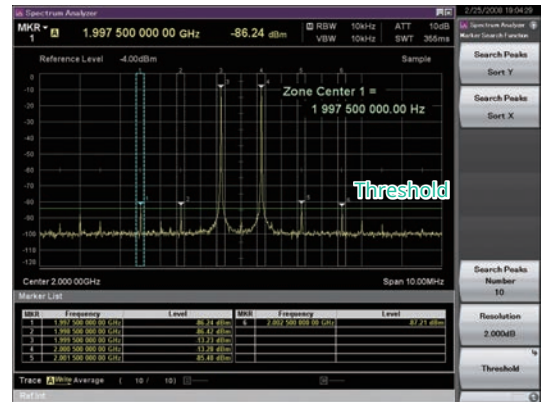

Measurement Results

- Marker point frequency
- Marker point power
- Absolute power per Hz in marker bandwidth
- Total power in marker bandwidth
- Difference between any markers

Highest 10 Markers (SPA) (VSA)

This function sets the threshold level and auto-detects peaks in the X (frequency) and Y (level/time) directions.

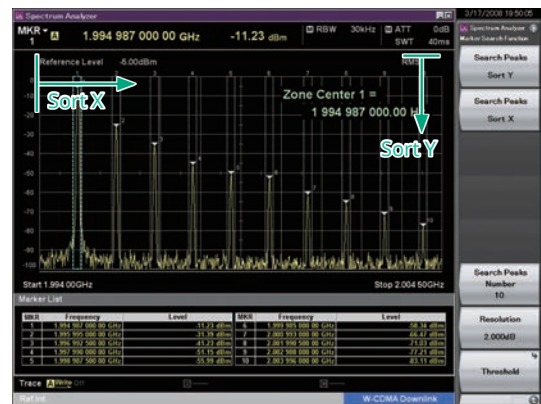

Measurement Results

- Peak Search Y:
 - Sets up to 10 markers in order of peak level
- Peak Search X:
 - Sets up to 10 markers in order of frequency (time) level

Versatile Built-in Functions

Limit Lines

(SPA)

Setting Limit Lines

Up to six types of Limit line can be set on the spectrum display (frequency domain).

In addition to setting the frequency and level of crossover points manually in sequence from the low frequency, after creating the right half of a line, the left half can be created by reversing and copying the right half, to set a symmetric limit line. Additionally, a Limit line that traces the measured waveform can be created using the Limit Envelope function. A margin can be set on the Limit line in the amplitude direction.

Evaluating using Limit Line Setting (Limit Test Function)

When the waveform is above or below the Limit line, it is evaluated automatically as PASS or FAIL. Evaluation is also possible with an added margin. The target evaluation line can be chosen from any of six types.

Auto-saving Waveform Data using Limit Line Setting (Save on Event Function)

When the waveform matches the evaluation conditions (Event), it can be saved automatically as a csv format file. Any one of the following five Event types can be selected.

- (1) Limit Fail: Saves waveform file when evaluation result is Fail
- (2) Limit Pass: Saves waveform file when evaluation result is Pass
- (3) Margin Fail: Saves waveform file when evaluation result including margin is Fail
- (4) Margin Pass: Saves waveform file when evaluation result including margin is Pass
- (5) Sweep Complete: Saves waveform file at every measurement regardless of evaluation result

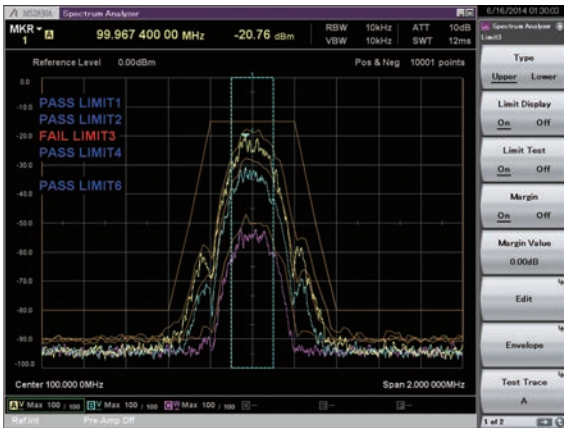

Example:

PASS/FAIL evaluation is performed by changing the input signal level. The evaluation results for the five line types can be displayed simultaneously on one screen.

- Line: Limit 1, Limit 2, Limit 3, Limit 4, Limit 5, Limit 6
- Evaluation Type: Upper Limit, Lower Limit
- Crossover (Point): 1 to 100
- Margin: Set Margin line for each Limit 1, 2, 3, 4, 5, 6
- Evaluation Result: PASS, FAIL
- Result Save: Auto-save as csv format file

Frequency Counter

(SPA)

This function of the marker functions is used to measure CW frequencies.

Gate Time sets the measurement target time.

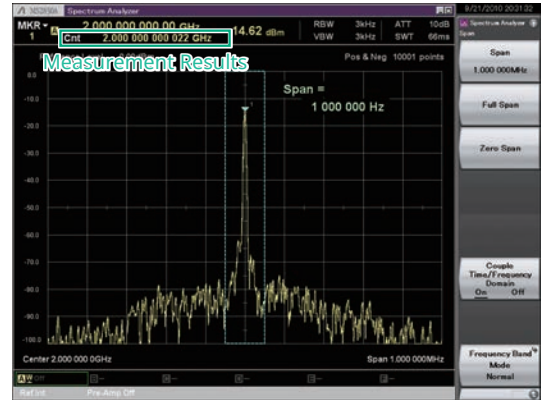

- Measurement Results
- Marker point frequency

2-tone 3rd-order Intermodulation Distortion

(SPA)

By inputting two different frequency CW signals (desired waves), two-tone third-order intermodulation distortion is generated close to the desired waves according to non-linear characteristics of Device Under Test (DUT). Then, Third Order Intercept (TOI) is calculated from the two-tone third-order intermodulation distortion.



Measurement Results

- TOI: [dBm]
- Amplitude: [dBc]

Versatile Built-in Functions

Annotation Display

SPA

Screen annotations can be set to On or Off. Annotations about frequency, level, etc., are not displayed at the Off setting.

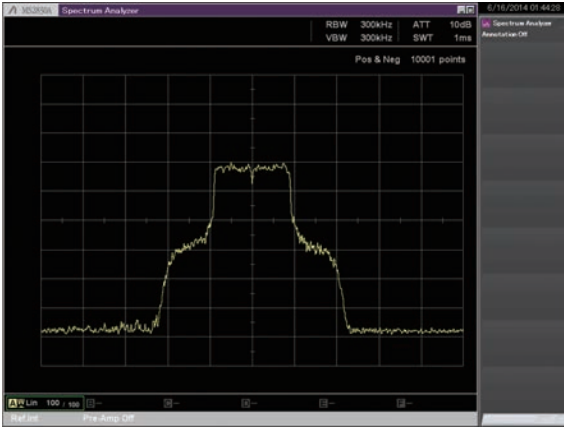

Power Meter

Power meter function can connect a USB power sensor to the MS2830A and read the measurement values.



Measurement Results

- Power: [dBm], [W]
- Relative power: [dB]

Compatible USB Power Sensors

Model	Frequency Range	Dynamic Range
MA24104A*	600 MHz to 4 GHz	+3 to +51.76 dBm
MA24105A	350 MHz to 4 GHz	+3 to +51.76 dBm
MA24106A	50 MHz to 6 GHz	-40 to +23 dBm
MA24108A	10 MHz to 8 GHz	-40 to +20 dBm
MA24118A	10 MHz to 18 GHz	-40 to +20 dBm
MA24126A	10 MHz to 26 GHz	-40 to +20 dBm

*: MA24104A has been discontinued.

Installing the PowerXpert™

Installing the PowerXpert™ PC application software for the Anritsu USB Power Sensor in the MS2830A supports various measurement functions offered by PowerXpert™, as well as use of other USB power sensors by the MS2830A.

PowerXpert™ for the MS2830A can be downloaded from the MS2830A and MS2830A Microwave product pages at the Anritsu website. When using the PowerXpert™ software with a PC, download the latest version from the USB Power Sensor product page at the Anritsu website.

Phase Noise (MS2830A-010)

This function measures phase noise in the 10 Hz to 10 MHz frequency offset range.



Measurement Results

- Carrier level
- Error between set frequency and carrier frequency
- Marker point phase noise level

Basic Performance Upgrade:

Low Phase Noise Performance (MS2830A-066)

The MS2830A with MS2830A-066 supports significantly improved phase noise performance, especially at carrier offsets of 1 kHz to 100 kHz.

Spectrum analyzer phase noise performance affects ACLR/MASK measurements at narrowband communications (Channel bandwidth: <100 kHz).

Add MS2830A-066 when required by the specifications.

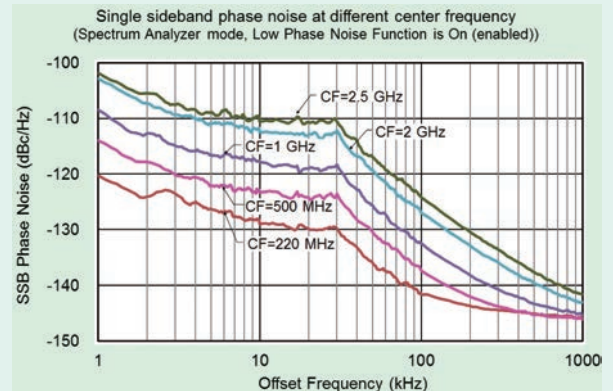

Versatile Built-in Functions

Noise Figure Measurement (MS2830A-017)

Noise Figure is measured with the measurement method of Y-factor method which uses a Noise Source.

- Frequency Mode: Fixed, List, Sweep
- DUT Mode: Amplifier, Down Converter, Up Converter
- Screen Layout: Graph, Table

Measurement Results Display
Graph, List, Spot

Displays measurement results for each trace (Trace1/Trace2).

- Noise Figure (NF) [dB]
- Noise Factor (F) [Linear]
- Gain
- Y-Factor: Power ratio when Noise Source is turned ON/OFF
- T effective: Effective noise temperature
- P Hot: Power measured when Noise Source is On.
- P Cold: Power measured when Noise Source is Off.

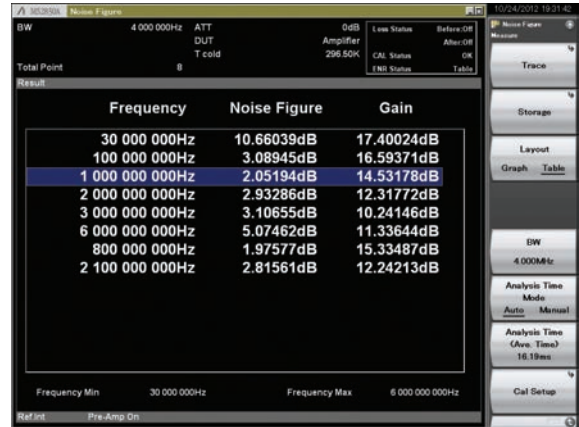

Measurement Result: Example of List display (Frequency Mode: List, Screen Layout: List)

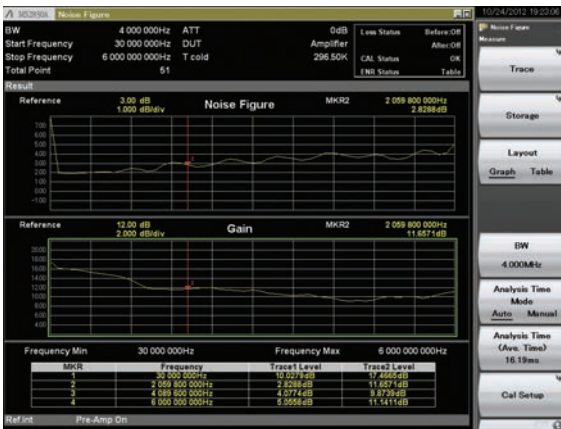

Measurement Result: Example of Graph display (Frequency Mode: Sweep, Screen Layout: Graph)

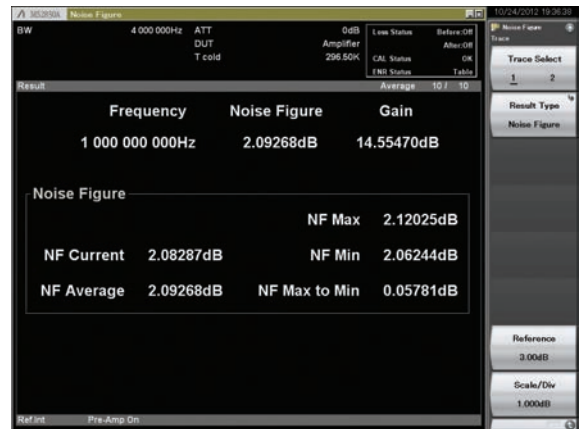

Measurement Result: Example of Spot display (Frequency Mode: Fixed)

Versatile Built-in Functions

Noise Source

Supports noise sources from Noisecom NC346 series. NC346 series models and summary specifications are listed below. See the NC346 series catalog and datasheet for detailed specifications.

NC346 series summary specifications

Model	RF Connector	Frequency [GHz]	Output ENR [dB]	VSWR (maximum @ on/off) [GHz]				DC Offset	DC Block
				0.01 to 5	5 to 18	18 to 26.5	26.5 to 40		
NC346A	SMA (M)	0.01 to 18.0	5 to 7	1.15:1	1.25:1	—	—	No	Not required
NC346A Precision	APC3.5 (M)	0.01 to 18.0	5 to 7	1.15:1	1.25:1	—	—	No	Not required
NC346A Option 1	N (M)	0.01 to 18.0	5 to 7	1.15:1	1.25:1	—	—	No	Not required
NC346A Option 2	APC7	0.01 to 18.0	5 to 7	1.15:1	1.25:1	—	—	No	Not required
NC346A Option 4	N (F)	0.01 to 18.0	5 to 7	1.15:1	1.25:1	—	—	No	Not required
NC346B	SMA (M)	0.01 to 18.0	14 to 16	1.15:1	1.25:1	—	—	No	Not required
NC346B Precision	APC3.5 (M)	0.01 to 18.0	14 to 16	1.15:1	1.25:1	—	—	No	Not required
NC346B Option 1	N (M)	0.01 to 18.0	14 to 16	1.15:1	1.35:1	—	—	No	Not required
NC346B Option 2	APC7	0.01 to 18.0	14 to 16	1.15:1	1.25:1	—	—	No	Not required
NC346B Option 4	N (F)	0.01 to 18.0	14 to 16	1.15:1	1.35:1	—	—	No	Not required
NC346D	SMA (M)	0.01 to 18.0	19 to 25*1	1.50:1	1.50:1	—	—	No	Not required
NC346D Precision	APC3.5 (M)	0.01 to 18.0	19 to 25*1	1.50:1	1.50:1	—	—	No	Not required
NC346D Option 1	N (M)	0.01 to 18.0	19 to 25*1	1.50:1	1.75:1	—	—	No	Not required
NC346D Option 2	APC7	0.01 to 18.0	19 to 25*1	1.50:1	1.50:1	—	—	No	Not required
NC346D Option 3	N (F)	0.01 to 18.0	19 to 25*1	1.50:1	1.75:1	—	—	No	Not required
NC346C	APC3.5 (M)	0.01 to 26.5	13 to 17	1.15:1	1.25:1	1.35:1	—	Yes*3	Required*3
NC346E	APC3.5 (M)	0.01 to 26.5	19 to 25*1	1.50:1	1.50:1	1.50:1	—	Yes*3	Required*3
NC346Ka	K (M)*2	0.10 to 40.0	10 to 17	1.25:1	1.30:1	1.40:1	1.50:1	Yes*3	Required*3

*1: Flatness better than ±2 dB

*2: Compatible with SMA and APC3.5

*3: When using noise sources output by DC, always use in combination with a DC block.

Specifications outlines of recommended DC Blocks and Adapters

	Ordering		RF Connector	Frequency Range	VSWR
	Model	Name			
DC Block	J0805	DC Block, N type (MODEL 7003)	N (M)-N (F)	10 kHz to 18 GHz	1.35 (max.)
	J1555A	DC Block, SMA type (MODEL 7006-1)	SMA (M)-SMA (F)	9 kHz to 20 GHz	1.50 (9 kHz to 10 kHz) 1.50 (11 kHz to 20 kHz) 1.30 (20 kHz to 20 GHz)
	J1554A	DC Block, SMA type (MODEL 7006)	SMA (M)-SMA (F)	9 kHz to 26.5 GHz	1.50 (9 kHz to 20 kHz) 1.35 (20 kHz to 20 GHz) 1.70 (20 GHz to 26.5 GHz)
	K261	DC Block	K (M)-K (F)	10 kHz to 40 GHz	See figure (return loss) below
Adapter	J0004	Coaxial Adapter	N (M)-SMA (F)	DC to 12.4 GHz	≤1.08 (DC to 3 GHz) ≤1.11 (3 GHz to 6 GHz) ≤1.18 (6 GHz to 12.4 GHz)
	J1398A	N-SMA Adapter	N (M)-SMA (F)	DC to 26.5 GHz	≤1.05 (DC to 3 GHz) ≤1.07 (3 GHz to 6 GHz) ≤1.2 (6 GHz to 13.5 GHz) ≤1.3 (13.5 GHz to 20 GHz) ≤1.45 (20 GHz to 26.5 GHz)

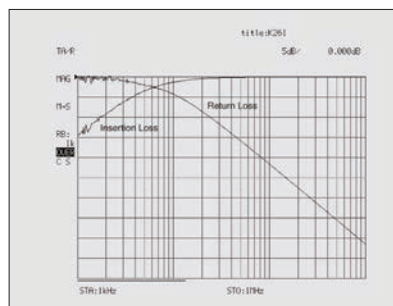

Typical Low Frequency Insertion Loss measured on K261 over the range of 1 kHz to 1 MHz.

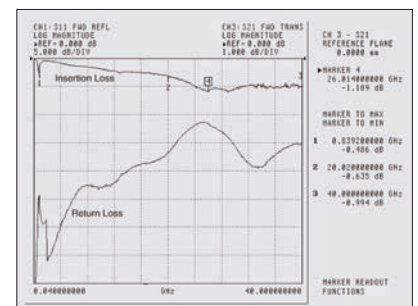

Insertion Loss and Return Loss measured on K261 over the range of 40 MHz to 40 GHz.

K261 DC Block Return Loss

Recommended DC blocks/Adaptor combinations for MS2830A/MS269xA series signal analyzer

	Model	Frequency Range	RF connector	Recommended DC Block Order Name	Recommended Adapter Order Name
MS2830A series	MS2830A-040	9 kHz to 3.6 GHz	N (F)	Not required	Not required
	MS2830A-041	9 kHz to 6 GHz	N (F)	Not required	Not required
	MS2830A-043	9 kHz to 13.5 GHz	N (F)	Not required	Not required
	MS2830A-044	9 kHz to 26.5 GHz	N (F)	J1554A	J1398A
	MS2830A-045	9 kHz to 43 GHz	K (F)	K261	Not required
MS269xA series	MS2690A	50 Hz to 6 GHz	N (F)	J1555A	J0004
	MS2691A	50 Hz to 13.5 GHz	N (F)	J1555A	J1398A
	MS2692A	50 Hz to 26.5 GHz	N (F)	J1554A	J1398A

Vector Signal Generator (MS2830A-020/021): Basic Performance

The Vector Signal Generator MS2830A-020/021 covers the frequency range from 250 kHz to 3.6 GHz/6.0 GHz; it has a wide vector modulation bandwidth of 120 MHz as well as a large built-in memory for storing 64 Msamples/256 Msamples (with MS2830A-027). Its level accuracy is at least as good as a dedicated signal generator and the ACLR performance is ideal for Tx tests of devices such as amplifiers and Rx tests of base stations. The all-in-one analyzer and signal generator supports simple configuration of space-saving measurement systems as well as easy signal analysis matching the output timing from the signal generator option.

Frequency Range

Frequency Range: 250 kHz to 3.6 GHz (MS2830A-020)
 250 kHz to 6 GHz (MS2830A-021)
 Resolution: 0.01 Hz step

The Vector Signal Generator option (MS2830A-020/021) frequency range is 250 kHz to 3.6 GHz/6.0 GHz, covering the key wireless communication range.

Output Level Range

Output Level Range:
 -40 to +20 dBm (without MS2830A-022, >25 MHz)
 -136 to +15 dBm (with MS2830A-022, >25 MHz)
 Resolution: 0.01 dB step

Internal Baseband Generator

Vector Modulation Bandwidth: 120 MHz
 Sampling Clock: 20 kHz to 160 MHz

The wideband 120-MHz vector modulation bandwidth is achieved using the MS2830A-020/021 baseband signal generator. The sampling clock supports up to 160 MHz.

Level Accuracy ±0.5 dB

Output Level Accuracy (CW):
 ±0.5 dB (typ.)
 (-110 dBm ≤ Level ≤ +4 dBm, 100 MHz ≤ Frequency ≤ 3.6 GHz)

Example: Frequency Characteristics (Referenced to -15 dBm)

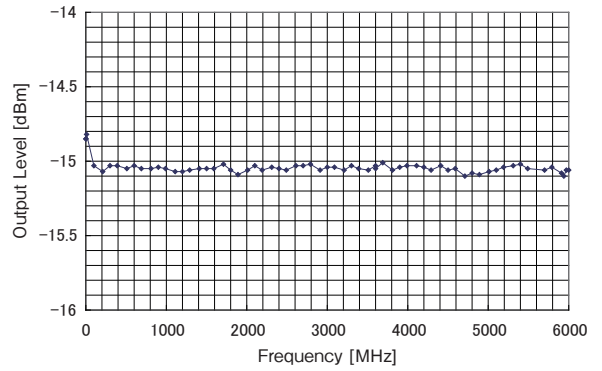

Example: Linearity (Referenced to -15 dBm)

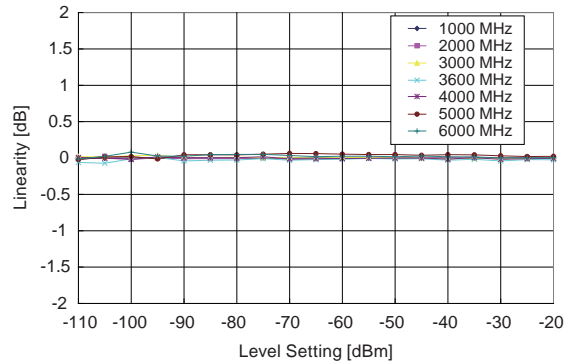

Example: Vector Modulation Bandwidth

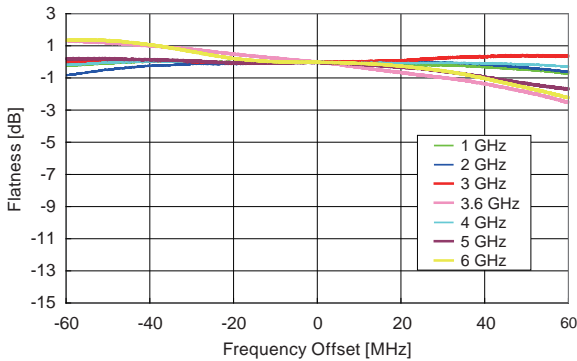

Example: SSB Phase Noise

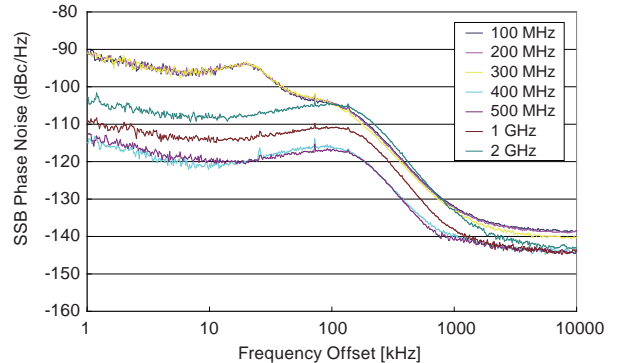

Vector Signal Generator (MS2830A-020/021): Basic Performance

Large-capacity Memory (MS2830A-027)

256 MB = 64 Msamples/channel (without MS2830A-027)
 1 GB = 256 Msamples/channel (with MS2830A-027)

The MS2830A-020/021 arbitrary waveform memory can save MAX. 256 Msamples/channel as well as multiple waveform patterns at the same time. Waveform patterns in memory can be output instantaneously by switching without need to recall from hard disk.

Internal AWGN Generator (MS2830A-028)

Absolute CN Ratio: ≤ 40 dB

This functions adds AWGN (Additive White Gaussian Noise) to the wanted waveform in memory. It is ideal for Tx dynamic range tests.

AWGN band set automatically to sampling clock of wanted signal.

Example: When wanted signal conditions are:

- W-CDMA
- Bandwidth = 3.84 MHz
- Over sampling = $\times 4$



Wanted Signal + AWGN Signal output from one unit

Versatile Multiple Waveform Generation

Any type of waveform can be generated using the MS2830A-020/021 Signal Generator option. In addition to using C and simulation tools, Anritsu's IQproducer can be run on a PC to edit waveform parameters and output waveforms.

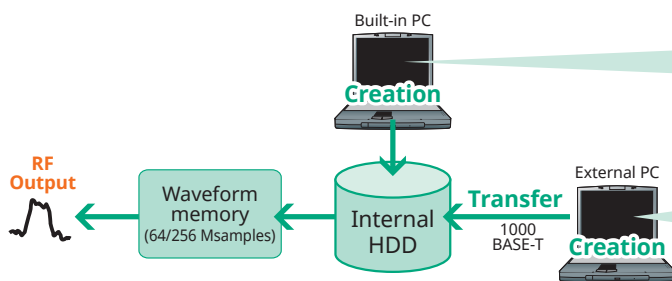

Creating Waveform Using IQproducer

IQproducer is PC software that is used to edit parameters and create any waveform pattern. It can be installed either on an external PC or in the MS2830A main frame.

- HSDPA/HSUPA IQproducer
- TDMA IQproducer
- Multi-carrier IQproducer
- Mobile WiMAX IQproducer
- LTE IQproducer
- LTE TDD IQproducer
- WLAN IQproducer
- TD-SCDMA IQproducer

Creating Any Waveform

IQ Data created using the MS2830A digitize function or by simulation tools or in C can be converted to a waveform pattern using the SG option and output.

Vector Signal Generator (MS2830A-020/021): Basic Performance

Useful IQproducer Waveform Generation Software

IQproducer is application software for a PC for editing, creating and transferring waveform patterns using the MS2830A-020/021 arbitrary waveform generation option. It has the following three main functions.

Parameter Editing:

Function for easily editing parameters matching each communication method

Simulation:

Function for checking generated waveform pattern before transfer to CCDF and FFT graphs

Conversion:

Function for converting ASCII format waveform patterns created by simulation software, files captured using digitizing function, and MG3700A/MS269xA-020 waveform patterns, into files that can be used by MS2830A-020/021

Parameter Setting Screen
(HSDPA/HSUPA IQproducer)

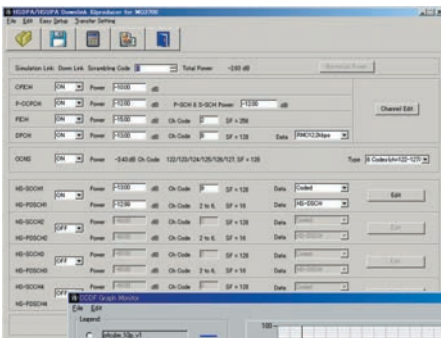

Simulation Screen
(CCDF)

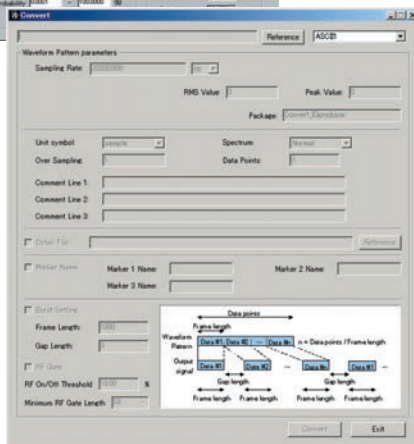
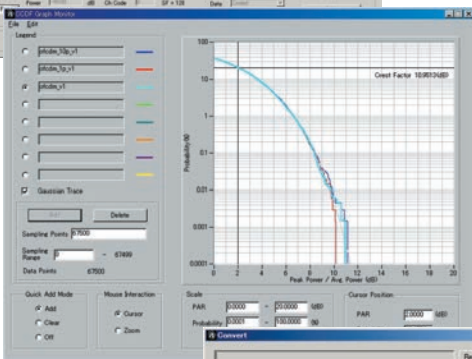

Convert Screen

BER Measurement Function (MS2830A-026): Basic Performance

Convenient Built-in BER Measurement Function for Rx Evaluations

The MS2830A with the BER Measurement Function MS2830A-026 supports measurement up to 10 Mbps. It supports Rx sensitivity tests by inputting the receiver-demodulated Data/Clock/Enable to the back of the MS2830A.

- Input Signal: Data, Clock, Enable (Polarity reversal supported)
- Input Bit Rate: 100 bps to 10 Mbps
- Input Level: TTL 3.3 V
- Connector: Rear panel, AUX connector*
- *: Can convert to BNC by connecting AUX conversion adapter (J1556A).
- Measured Patterns:
 - PN9, PN11, PN15, PN20, PN23, ALL0, ALL1, Alternate (0101...),
 - PN9Fix, PN11Fix, PN15Fix, PN20Fix, PN23Fix,
 - UserDefine (4096 bits Max.)
- Measurable Bit Count: 1000 to 4294967295 bits ($2^{32} - 1$ bits)
- Measurable Error Bit Count: 1 to 2147483647 bits ($2^{31} - 1$ bits)
- Count Mode
 - Data: Measures until specified Data count
 - Error: Measures until specified Error count
- Measurement Mode
 - Single: Measures specified measurement bit count once
 - Continuous: Repeats Single measurement
 - Endless: Continues measurement to upper limit of measurement bits



BER Measurement Function Main Screen

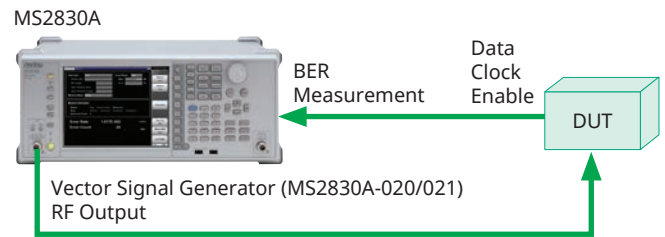

BER Measurement Setup Example (with MS2830A-020/021 installed)

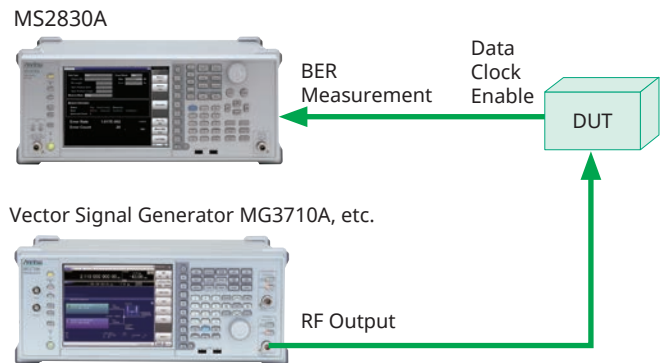

BER Measurement Setup Example (using external vector signal generator)

Excellent Expandability Platform (Hardware)

The versatility of the MS2830A series is tailored easily to the application by installing modules in expansion slots.

Basic Function and Performance Upgrades

Rubidium Reference Oscillator/Retrofit MS2830A-001/101

This option is a 10 MHz reference crystal oscillator with excellent frequency stability startup characteristics of $\pm 1 \times 10^{-9}$ at 7 minutes after power-on.

Aging Rate: $\pm 1 \times 10^{-10}$ /month
 Start-up Characteristics: $\pm 1 \times 10^{-9}$ (7 minutes after power-on)

High Stability Reference Oscillator/Retrofit MS2830A-002/102

The 10 MHz reference oscillator improving frequency stability up to aging rate: $\pm 1 \times 10^{-8}$ /day

Aging Rate: $\pm 1 \times 10^{-8}$ /day
 Start-up Characteristics: $\pm 5 \times 10^{-8}$ (5 minutes after power-on)

Preamplifier/Retrofit MS2830A-008/108

This option increases the sensitivity of the spectrum/signal analyzer functions and is used for examining low-level signals such as interference waveforms.

Precompliance EMI Function/Retrofit MS2830A-016/116

This option adds an EMI measurement detection mode and RBW to the spectrum analyzer function. Both the detection mode used for CISPR standards (Quasi-Peak, CISPR-AVG, RMS-AVG) and RBW (200 Hz (6 dB), 9 kHz (6 dB), 120 kHz (6 dB), 1 MHz (Imp)) as well as conventional settings can be selected.

Low Phase Noise Performance MS2830A-066

Phase noise performance is increasingly important at carrier offsets of 1 kHz to 100 kHz.

Spectrum analyzer phase noise performance affects ACLR/MASK measurements at narrowband communications.

(Channel bandwidth : <100 kHz)

Add MS2830A-066 when required by the specifications.

Frequency Range: 9 kHz to 3.7 GHz
 (Frequency band mode:* Normal)
 9 kHz to 3.5 GHz
 (Frequency band mode:* Spurious)

*: Requires MS2830A-041/043 for setting.

Span: 300 Hz to 1 MHz (Spectrum Analyzer)
 1 kHz to 31.25 MHz (Signal Analyzer)

MS2830A-066 cannot be retrofitted
 MS2830A-066 sometimes cannot be installed depending on options.

Model	Case 1	Case 2	Case 3
MS2830A-020/021	Yes	Yes	No
MS2830A-043	Yes	No	Yes
MS2830A-066	No	Yes	Yes

Signal Analyzer Function and Performance Upgrade

Analysis Bandwidth Extension to 31.25 MHz/Retrofit MS2830A-005/105

Extends analysis bandwidth to 31.25 MHz.

*: Requires MS2830A-006.

Analysis Bandwidth 10 MHz/Retrofit MS2830A-006/106

This option supports the VSA and digitize functions.

Analysis Bandwidth Extension to 62.5 MHz MS2830A-077

Extends analysis bandwidth to 62.5 MHz.

*: Retrofit not supported.

*: Requires MS2830A-005 and MS2830A-006.

Analysis Bandwidth Extension to 125 MHz MS2830A-078

Extends analysis bandwidth to 125 MHz.

*: Retrofit not supported.

*: Requires MS2830A-005, MS2830A-006 and MS2830A-077.

Note: An image response is received when setting the bandwidth to more than 31.25 MHz. This can be used when not inputting a signal frequency outside the MS2830A analysis bandwidth (125 MHz max.). The Signal Analyzer series MS2690A/91A/92A is recommended for other measurement purposes.

Excellent Expandability Platform (Hardware)

Expansion Functions

Phase Noise Measurement Function/Retrofit MS2830A-010/110

Phase Noise Measurements

Frequency Range: 10 MHz to main-frame upper limit frequency
Offset Frequency Range: 10 Hz to 10 MHz

2ndary HDD/Retrofit MS2830A-011/111

This removable 2ndary HDD is installed in the HDD Option Slot of the MS2830A main frame to expand the user data storage space. It does not have the Windows OS installed. The MS2830A ships with it installed. Only one expansion HDD can be installed in the MS2830A. It is useful when taking the instrument for calibration but the security of saved user data, such as measurement results, must be protected.

2ndary HDD Retrofit MS2830A-311

This removable 2ndary HDD is installed in the HDD Option Slot of the MS2830A main frame to expand the user data storage space. It does not have the Windows OS installed. It is useful when taking the instrument for calibration but the security of saved user data, such as measurement results, must be protected.

Noise Figure Measurement Function/Retrofit MS2830A-017/117

Adds noise figure measurement function.
Noise Figure is measured with the measurement method of Y-factor method which uses a Noise Source.

Audio Analyzer/Retrofit MS2830A-018/118

Adds AF signal Input/Output function. Measurement operation performed using Analog Measurement Software MX269018A.

★: Requires MX269018A

BER Measurement Function/Retrofit MS2830A-026/126

Adds BER measurement function.
It supports Rx sensitivity tests by inputting the receiver-demodulated Data/Clock/Enable to the back of the MS2830A.

Input Bit Rate: 100 bps to 10 Mbps

Input Level: TTL

Connector: Rear panel, AUX connector*

★: Can convert to BNC by connecting AUX Conversion Adapter (J1556A).

3.6 GHz Vector Signal Generator/Retrofit MS2830A-020/120

Cover frequency ranging from 250 kHz to 3.6 GHz with 120 MHz wideband vector modulation bandwidth

6 GHz Vector Signal Generator/Retrofit MS2830A-021/121

Cover frequency ranging from 250 kHz to 6 GHz with 120 MHz wideband vector modulation bandwidth

Low Power Extension for Vector Signal Generator/Retrofit MS2830A-022/122

Extends lower limit of output level from -40 to -136 dBm

(Note: 5-dB drop in upper output level)

ARB Memory Upgrade 256 Msa for Vector Signal Generator/Retrofit MS2830A-027/127

Extends ARB memory capacity from 64 Msample to 256 Msample

AWGN/Retrofit MS2830A-028/128

AWGN generator function

Analog Function Extension for Vector Signal Generator MS2830A-029

Adds analog signal generation function using Analog Measurement Software MX269018A to Vector Signal Generator option (MS2830A-020/021). Can calibrate lower limit frequency up to 100 kHz (MS2830A-020/021 lower limit frequency is 250 kHz)

★: Requires MX269018A, MS2830A-020 or 021, and MS2830A-022

3.6 GHz Analog Signal Generator/Retrofit MS2830A-088/188

Outputs analog signals and includes low power expansion (equivalent to MS2830A-022). Measurement operation performed using Analog Measurement Software MX269018A.
Can calibrate lower limit frequency up to 100 kHz (MS2830A-020/021 lower limit frequency is 250 kHz)

★: Requires MX269018A

★: Vector modulation signal output not supported (added by MS2830A-189)

Vector Function Extension for Analog Signal Generator Retrofit MS2830A-189

Installs license required for vector signal generation in existing Analog Signal Generator (MS2830A-088/188).
Use following options when ordering new Analog Signal Generator + Vector Signal Generator:

• MS2830A-020 or 021 + MS2830A-022 + MS2830A-029 + MX269018A + MS2830A-066 + A0086C

Internal Signal Generator Control Function/User-Installable MS2830A-052/352

The transmission characteristics of amplifiers, filters etc., can be measured using linked operation between the Spectrum Analyzer function and the Vector Signal Generator option (MS2830A-020/120 or 021/121) or the Analog Signal Generator option (MS2830A-088/188).

★: Requires any of MS2830A-020/120, 021/121, or 088/188.

Future-proof Platform (Software*)

*: See each software catalog for more details.

Adding measurement software options to the signal analyzer assures that the modulation analysis and other functions will support all common current and future communications systems.

Measurement Software

Communications Systems	Model	Name	Addition to Main frame (✓: Can be installed, No: Cannot be installed)		Analysis Bandwidth Extension Option (✓: Required, ✓+: Function expansion, Space (no symbol): No specification)			
			Opt. 040/041/043	Opt. 044/045	Opt. 006	Opt. 005/009	Opt. 077	Opt. 078
LTE/LTE-Advanced (FDD)	MX269020A	LTE Downlink Measurement Software	✓	✓	✓	✓		
	MX269020A-001	LTE-Advanced FDD Downlink Measurement Software	✓	✓	✓	✓	✓+*1	✓+*1
	MX269021A	LTE Uplink Measurement Software	✓	✓	✓	✓		
	MX269021A-001	LTE-Advanced FDD Uplink Measurement Software	✓	✓	✓	✓	✓+	✓+
LTE/LTE-Advanced (TDD)	MX269022A	LTE TDD Downlink Measurement Software	✓	✓	✓	✓		
	MX269022A-001	LTE-Advanced TDD Downlink Measurement Software	✓	✓	✓	✓	✓+*1	✓+*1
	MX269023A	LTE TDD Uplink Measurement Software	✓	✓	✓	✓		
	MX269023A-001	LTE-Advanced TDD Uplink Measurement Software	✓	✓	✓	✓	✓+	✓+
W-CDMA/HSPA/ HSPA Evolution	MX269011A	W-CDMA/HSPA Downlink Measurement Software	✓	✓	✓			
	MX269012A	W-CDMA/HSPA Uplink Measurement Software	✓	✓	✓			
W-CDMA/HSPA (Downlink)	MX269030A	W-CDMA BS Measurement Software	✓	✓	✓			
TD-SCDMA	MX269015A	TD-SCDMA Measurement Software	✓	✓	✓			
CDMA2000	MX269024A	CDMA2000 Forward Link Measurement Software	✓	✓	✓			
	MX269024A-001	All Measure Function	✓	✓	✓			
1xEV-DO	MX269026A	EV-DO Forward Link Measurement Software	✓	✓	✓			
	MX269026A-001	All Measure Function	✓	✓	✓			
GSM/EDGE	MX269013A	GSM/EDGE Measurement Software	✓	✓	✓			
EDGE Evolution	MX269013A-001	EDGE Evolution Measurement Software	✓	✓	✓			
World Digital Wireless Standards	MX269017A	Vector Modulation Analysis Software	✓	✓*2	✓	✓+*3	✓+*3	✓+*3
Analog (FM/ΦM/AM)	MX269018A	Analog Measurement Software	✓*4	No				
WLAN IEEE 802.11a/b/g/n/j/p	MX269028A	WLAN (802.11) Measurement Software (Supports IEEE 802.11n/11a/11b/11g/11j/11p)	✓	✓	✓	✓		
WLAN IEEE 802.11ac (80 MHz)	MX269028A-001*5	802.11ac (80 MHz) Measurement Software	✓	✓	✓	✓	✓	✓
WLAN IEEE 802.11a/b/g/n	MX283027A	Wireless Network Device Test Software	✓	✓	✓	✓		
WLAN	MX283027A-001	WLAN Test Software	✓	✓	✓	✓		
Bluetooth	MX283027A-002	Bluetooth Test Software	✓	✓	✓	✓		

*1: The LTE-Advanced Carrier Aggregation measurement range varies as follows, depending on the Analysis Bandwidth Extension option configuration.

Main frame	Analysis Bandwidth Extension Option Configuration	Maximum Analysis Bandwidth (In-band carrier aggregation range)	Maximum Number of Bands	Maximum Number of Component Carriers
MS2830A	MS2830A-078 installed	125 MHz	1	5
	MS2830A-077 installed	31.25 MHz	3	5
	MS2830A-005/009 installed	31.25 MHz	3	5
MS269xA	MS269xA-078 installed	125 MHz	3	5
	MS269xA-077 installed	31.25 MHz	3	5
	Standard	31.25 MHz	3	5

*2: By the measurement of the narrowband signal, add MS2830A-066. (Channel bandwidth: x kHz to 100 kHz)
MS2830A-044/045 cannot be installed MS2830A-066.

*3: The Symbol Rate setting range varies as follows, depending on the option configuration.

	O-QPSK	FSK	Except FSK	
			Frame Formatted	Non-Formatted
MS2830A-078, 077, 005, 006 installed	0.1 ksp/s to 12.5 Msp/s	0.1 ksp/s to 25 Msp/s	0.1 ksp/s to 50 Msp/s	0.1 ksp/s to 140 Msp/s
MS2830A-077, 005, 006 installed	0.1 ksp/s to 6.25 Msp/s	0.1 ksp/s to 12.5 Msp/s	0.1 ksp/s to 25 Msp/s	0.1 ksp/s to 70 Msp/s
MS2830A-005, 006 installed	0.1 ksp/s to 3.125 Msp/s	0.1 ksp/s to 6.25 Msp/s	0.1 ksp/s to 12.5 Msp/s	0.1 ksp/s to 35 Msp/s
MS2830A-006 installed	0.1 ksp/s to 1.25 Msp/s	0.1 ksp/s to 2.5 Msp/s	0.1 ksp/s to 5 Msp/s	0.1 ksp/s to 5 Msp/s

*4: MS2830A-043 can implement only either MS2830A-020/021 or MS2830A-066.

By the system that MS2830A-066 is necessary, MS2830A-020/021 is not added to MS2830A-043.

*5: Requires MX269028A. The IEEE 802.11ac measurement range varies as follows, depending on the Analysis Bandwidth Extension option configuration.

Main frame	Measurement software	Model	Bandwidth of IEEE 802.11ac signal					
			Analysis Bandwidth Extension Option Configuration	20 MHz	40 MHz	80 MHz	160 MHz	80 MHz + 80 MHz
MS2830A	MX269028A-001 (Only for MS2830A)	MS2830A-078 installed		✓	✓	✓*5-2		
		MS2830A-077 installed		✓	✓			
		MS2830A-005/009 installed		✓	✓			
MS269xA	MX269028A-002 (Only for MS269xA)	MS269xA-078 installed		✓	✓		✓	✓*5-1
		MS269xA-077 installed		✓	✓			
		Standard		✓	✓			

*5-1: Measurement required for each carrier signal (80-MHz bandwidth)

*5-2: Measurement is only possible when the carrier signal (80-MHz bandwidth) is input due to the effect of the image response.

CDMA2000® is a registered trademark of the Telecommunications Industry Association (TIA-USA).

The Bluetooth® word mark and logos are registered trademarks owned by Bluetooth SIG, Inc. and are used of such marks by Anritsu is under license.

IQproducer™ is a trademark of Anritsu Corporation.

Future-proof Platform (Software*)

Measurement Software for Smart Meter

This software is for PC. This software supports automatic measurement of the PHY layer and protocol analysis of the PHY/MAC layer of smart utility network wireless communications (Wi-SUN).

Wi-SUN PHY Measurement Software* ¹	MX705010A
Wi-SUN Protocol Monitor* ²	MX705110A

The MX705010A*¹ supports automatic measurement of Wi-SUN Alliance PHY Conformance test cases. The MS2830A is controlled by remote commands from this software.

*¹: Cannot be installed in MS2830A.
Requires the latest firmware of MS2830A.
This service, which provides updated versions of firmware and software for downloading by product customers, is available on Anritsu's website.
<<https://my.anritsu.com/home>>

Options Configuration Examples
MS2830A-041, MS2830A-002, MS2830A-006, MX269017A, MS2830A-020, MS2830A-022, MS2830A-027, MX269902A

MX705110A*² is possible to check the details of a Wi-SUN protocol. The wireless signals*³ between communicating wireless equipments are captured as I/Q data using the MS2830A digitize function and data analysis is performed by this software. Data analysis displays the PHY/MAC frame format, Tx timing, etc.

*²: Cannot be installed in MS2830A.
Requires the latest firmware of MS2830A.
*³: IEEE 802.15.4g/e (GFSK)

Wi-SUN® is a registered trademark of Wi-SUN Alliance.

Adding a license for the IQproducer waveform generation software to the vector signal generator option supports easy generation of test patterns for all common communications systems worldwide.

IQproducer License for MS2830A-020/021 VSG

Following licenses (option) are required to download waveform pattern created with IQproducer to the MS2830A with vector signal generator option and output signals.

HSDPA/HSUPA IQproducer	MX269901A
TDMA IQproducer	MX269902A
Multi-carrier IQproducer	MX269904A
Mobile WiMAX IQproducer	MX269905A
LTE IQproducer	MX269908A
LTE-Advanced FDD Option	MX269908A-001* ⁴
LTE TDD IQproducer	MX269910A
LTE-Advanced TDD Option	MX269910A-001* ⁵
WLAN IQproducer	MX269911A
802.11ac (80 MHz) Option	MX269911A-001* ⁶
TD-SCDMA IQproducer	MX269912A

*⁴: Requires MX269908A
*⁵: Requires MX269910A
*⁶: Requires MX269911A

IQproducer™ is a trademark of Anritsu Corporation.

Waveform patterns for MS2830A-020/021 VSG

Various waveforms with preset parameters matching each communication method are provided. The MS2830A-020/021 Vector Signal Generator option outputs RF signals. Pre-installed reference waveforms are saved on the MS2830A hard disk for free use.

- Pre-installed patterns
 - W-CDMA
 - HSDPA (Test Model5)
 - CDMA2000 1xEV-DO
 - CDMA2000
 - GSM/EDGE
 - Digital Broadcasting (ISDB-T/CS/BS/CATV)
 - WLAN (IEEE 802.11a/b/g)
 - Bluetooth
- Option Patterns
 - 1xEV-DO Reverse Receiver Test Waveform Pattern MX269970A

Excellent-Expandability Platform (Analog Radio Equipment Measurement)

Supports Key TRx Performance Tests (FM/ΦM/AM) Required by Analog Equipment

Combining the MS2830A-088 (or 029) 3.6 GHz Analog Signal Generator, MS2830A-018 Audio Analyzer and Analog Measurement Software options MX269018A in the all-in-one MS2830A main frame supports the simultaneous RF and AF signals required for implementing key TRx tests of analog radio equipment.

At Tx tests, the AF signal output from the Audio Analyzer is input to the radio equipment and the RF signal output from the radio is measured. As well as simultaneously outputting an AF signal with up to three tones, tone + DCS, white noise (ITU-T G.227), and DTMF signals can also be output. Furthermore, at RF signal measurement, the Tx frequency, power, modulation, demodulated AF signal frequency, level, and distortion can be displayed simultaneously on time vs. level and frequency vs. level graphs. The DCS Code is also displayed at frequency modulation. By using the spectrum analyzer display it is also possible to measure the spurious and occupied bandwidth (OBW) while outputting an AF signal such as white noise (ITU-T G.227) from the Audio Analyzer. The Audio Analyzer option has a Push To Talk (PTT) connector for On/Off control of the radio equipment PTT.

At Rx tests, the RF signal output from the Analog Signal Generator is input to the radio equipment and the AF signal from the radio is measured using the Audio Analyzer. As well as outputting up to three AF tones simultaneously from the internal modulation signal source of the Analog Signal Generator, both DCS (FM only) and Wave audio format files can be output as signals. At AF signal measurement using the Audio Analyzer, the frequency, level and distortion (SINAD measurement, etc.) can be displayed simultaneously on time vs. level and frequency vs. level graphs.

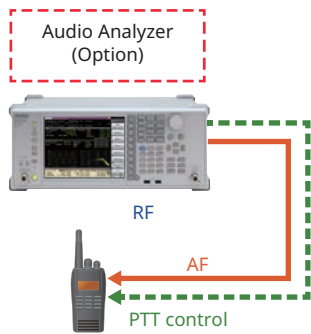

Tx Characteristics Test Setup

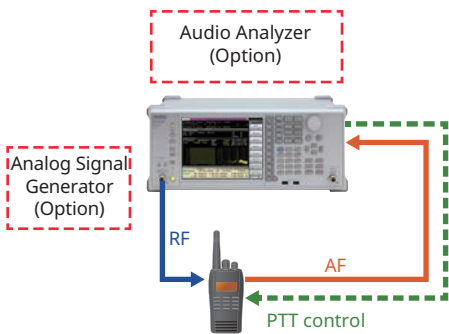

Rx Sensitivity Test Setup

Tx Tests

Key Measurement Test Items (FM Radio Equipment)

Tx Power, Tx Frequency, FM Deviation, Microphone input sensitivity, Modulation frequency characteristics, Distortion, S/N, Tone frequency, Occupied bandwidth (OBW)/Spurious emission or Unwanted emission strength (White noise (ITU-T G.227) output supported)

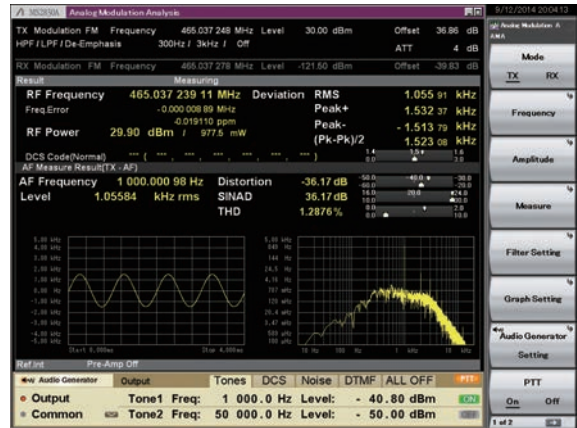

Example of AF Signal Output (bottom) and FM Signal (top) Measurement

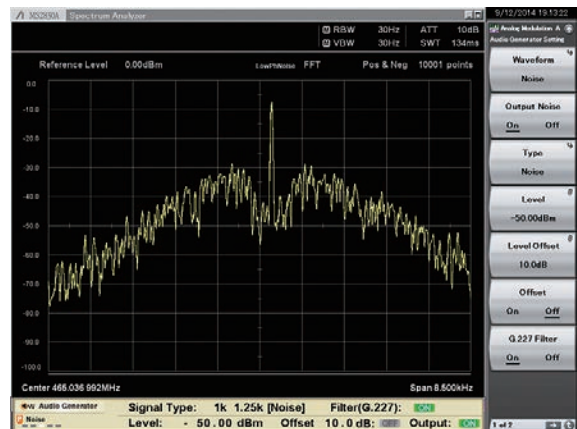

Example of White Noise (ITU-T G.227) Output (bottom) and Spectrum Analyzer (top)

Rx Tests

Key Measurement Test Items (FM Radio Equipment)

Receiving sensitivity (SINAD and NQ method), Bandwidth, AF level, Demodulation frequency characteristics, Distortion, S/N, Squelch sensitivity

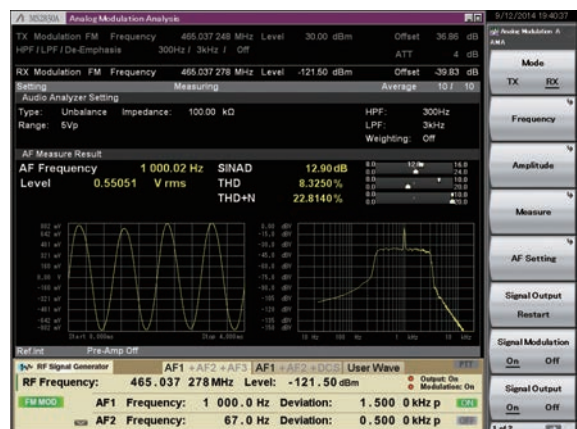

Example of FM Signal Output (bottom) and AF Signal (top) Measurement

Excellent-Expandability Platform (Digital LMR/PMR Measurement)

Digital Radio ($\pi/4$ DQPSK, 4FSK, etc.)

Combining the Vector Modulation Analysis Software MX269017A with the Low Phase Noise Performance MS2830A-066, 3.6 GHz Vector Signal Generator MS2830A-020, and BER Measurement Function MS2830A-026 supports all-in-one measurement of key TRx characteristics of narrow-band digital radio.

As Tx test items, it covers Tx frequency and power measurement of the RF signal output from the radio, as well as the $\pi/4$ DQPSK, QPSK, and 16QAM modulation accuracy (EVM), the zero offset, 4FSK modulation accuracy (FSK Error), and frequency shift at each symbol rate. It has the parameters supporting easy settings for the standards and technologies.

- APCO P25, NXDN, TETRA, DMR, dPMR, etc.
- ARIB STD-T61, T79, T86, T98, T102, etc.

Adding the Low Phase Noise MS2830A-066 option uses a unique circuit technology to improve the MS2830A close-in phase noise by about 20 dB. As well as supporting the severe close-in spurious measurement standards, this platform also has sufficient margins for measuring adjacent channel leakage power.

Rx tests measure the bit error rate (BER) by inputting an RF signal output from a vector signal generator to the radio and then inputting the demodulated Data and Clock from the radio to the MS2830A.

Vector Modulation Analysis Software (Option)
Low Phase Noise Performance (Option)



Tx Characteristics Test Setup

BER Measurement Function (Option)
Vector Signal Generator Option

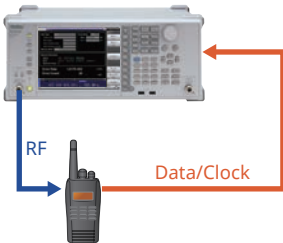

Rx Sensitivity Test Setup

Tx Tests

Key Tx Test Items

Tx Power, Tx Frequency, Modulation Accuracy, Zero Offset, Frequency Shift, Occupied Bandwidth, Adjacent Channel Leakage Power, Spurious Emissions, and Unwanted Emissions



4FSK Modulation Analysis Measurement Example

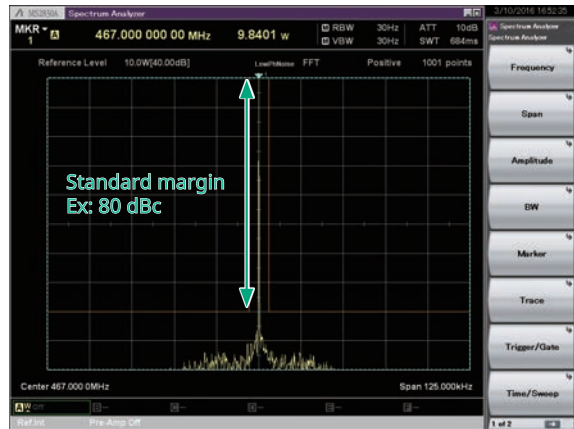

Spurious Emissions (out-of-band) Measurement Example

Rx Test

Key Test Items

Rx Sensitivity (BER)



BER Measurement Function (top) and Vector Signal Generator (bottom) Measurement Examples

Signal Analyzer MS2830A Specifications

The specification is the value after 30-minute warm-up at a constant ambient temperature.

The specifications are defined under the following conditions unless otherwise specified.

Auto sweep time select: Normal, Auto sweep type rules: Sweep only, Switching speed mode: Best phase noise mode,

Attenuator mode: Mechanical Attenuator Only

Nominal values indicate expected performance or describe product performance. That is not covered by the product warranty.

Signal Analyzer/Spectrum Analyzer

Frequency

Frequency Range	9 kHz to 3.6 GHz [MS2830A-040] 9 kHz to 6 GHz [MS2830A-041] 9 kHz to 13.5 GHz [MS2830A-043]		
Frequency Bands	Frequency range	Band	Mixer harmonics order (N)
	9 kHz to 4 GHz	0	1
	3.5 GHz to 4.4 GHz	1	1/2
	4.3 GHz to 6.1 GHz	1	1
	5.9 GHz to 10.575 GHz	2	1
	10.425 GHz to 13.6 GHz	2	2
Frequency Setting Range	-100 MHz to 3.7 GHz [MS2830A-040] -100 MHz to 6.1 GHz [MS2830A-041] -100 MHz to 13.6 GHz [MS2830A-043] Setting resolution: 1 Hz		
Pre-Selector Range	MS2830A-041	MS2830A-043	(Frequency band mode: Normal) (Frequency band mode: Spurious)
	4 GHz to 6 GHz	4 GHz to 13.5 GHz	
	3.5 GHz to 6 GHz	3.5 GHz to 13.5 GHz	
Internal Reference Oscillator	without MS2830A-001/002 Aging rate: $\pm 1 \times 10^{-6}$ /year, $\pm 1 \times 10^{-7}$ /day Temperature stability: $\pm 2.5 \times 10^{-6}$ (5° to 45°C)		
	with MS2830A-001 23°C, Referenced to frequency at 24-hour after power-on Start-up characteristics: $\pm 1 \times 10^{-9}$ (7 minutes after power-on) Aging rate: $\pm 1 \times 10^{-10}$ /month Temperature stability: $\pm 1 \times 10^{-9}$ (5° to 45°C)		
	with MS2830A-002 23°C, Referenced to frequency at 24-hour after power-on Start-up characteristics: $\pm 5 \times 10^{-7}$ (2 minutes after power-on) $\pm 5 \times 10^{-8}$ (5 minutes after power-on) Aging rate: $\pm 1 \times 10^{-7}$ /year, $\pm 1 \times 10^{-8}$ /day Temperature stability: $\pm 2 \times 10^{-8}$ (5° to 45°C)		
	SSB Phase Noise		
	18° to 28°C, 500 MHz, Spectrum Analyzer, Switching speed mode: Normal -115 dBc/Hz (100 kHz offset) -133 dBc/Hz (1 MHz offset)		

Amplitude

Level Measurement Range	without MS2830A-008, or Preamp: Off DANL to +30 dBm with MS2830A-008, Preamp: On DANL to +10 dBm
Maximum Input Level	without MS2830A-008, or Preamp: Off Average total power: +30 dBm (Input attenuator: ≥ 10 dB) +20 dBm (Input attenuator: 0 dB) DC voltage: ± 10 Vdc with MS2830A-008, Preamp: On Average total power: +10 dBm (Input attenuator: 0 dB) DC voltage: ± 10 Vdc
Input Attenuator Range	0 to 60 dB, 2 dB steps
Input Attenuator Switching Uncertainty	18° to 28°C, Referenced to 10 dB without MS2830A-008, or Preamp: Off Frequency band mode: Normal ± 0.2 dB (<4 GHz, 10 to 60 dB) ± 0.75 dB (≥ 4 GHz, 10 to 60 dB) Frequency band mode: Spurious ± 0.2 dB (<3.5 GHz, 10 to 60 dB) ± 0.75 dB (≥ 3.5 GHz, 10 to 60 dB)

Signal Analyzer MS2830A Specifications

Signal Analyzer/Spectrum Analyzer (Continued)

Reference Level

Setting Range	Log scale: -120 to +50 dBm, or Equivalent level Linear scale: 22.4 μ V to 70.7 V, or Equivalent level Setting resolution: 0.01 dB, or Equivalent level
Scale Units	Log scale: dBm, dB μ V, dBmV, dB μ V (emf), dB μ V/m, V, W Linear scale: V
Linearity Error	Excluding the noise floor effect without MS2830A-008, or Preamp: Off ± 0.07 dB (Mixer input level: ≤ -20 dBm) ± 0.10 dB (Mixer input level: ≤ -10 dBm) with MS2830A-008, Preamp: On ± 0.07 dB (Preamp input level: ≤ -40 dBm) ± 0.10 dB (Preamp input level: ≤ -30 dBm)
RF Frequency Characteristics	18° to 28°C, after CAL, Input attenuator: 10 dB without MS2830A-008, or Preamp: Off ± 1.0 dB ($9 \text{ kHz} \leq f < 300 \text{ kHz}$) ± 0.35 dB ($300 \text{ kHz} \leq f < 4 \text{ GHz}$, Frequency band mode: Normal) ($300 \text{ kHz} \leq f < 3.5 \text{ GHz}$, Frequency band mode: Spurious) ± 1.5 dB ($4 \text{ GHz} \leq f \leq 6 \text{ GHz}$, Frequency band mode: Normal) ($3.5 \text{ GHz} \leq f \leq 6 \text{ GHz}$, Frequency band mode: Spurious) ± 1.5 dB ($6 \text{ GHz} < f$) with MS2830A-008, Preamp: On ± 0.65 dB ($300 \text{ kHz} \leq f < 4 \text{ GHz}$, Frequency band mode: Normal) ($300 \text{ kHz} \leq f < 3.5 \text{ GHz}$, Frequency band mode: Spurious) ± 1.8 dB ($4 \text{ GHz} \leq f \leq 6 \text{ GHz}$, Frequency band mode: Normal) ($3.5 \text{ GHz} \leq f \leq 6 \text{ GHz}$, Frequency band mode: Spurious)
1 dB Gain Compression	without MS2830A-008, or Preamp: Off, at Mixer input level $\geq +3$ dBm ($300 \text{ MHz} \leq f \leq 6 \text{ GHz}$) ≥ -1 dBm ($6 \text{ GHz} < f \leq 13.5 \text{ GHz}$) with MS2830A-008, Preamp: On, at Preamp input level ≥ -15 dBm ($300 \text{ MHz} \leq f \leq 6 \text{ GHz}$)

Spurious Responses

Second Harmonic Distortion	without MS2830A-008, or Preamp: Off Mixer input level: -30 dBm		
	Harmonic distortion	SHI	$(10 \text{ MHz} \leq f \leq 300 \text{ MHz})$ $(300 \text{ MHz} < f \leq 2 \text{ GHz})$
	≤ -60 dBc	$\geq +30$ dBm	
	≤ -65 dBc	$\geq +35$ dBm	
Mixer input level: -10 dBm			
	Harmonic distortion	SHI	$(2 \text{ GHz} < f \leq 3 \text{ GHz}, \text{ Frequency band mode: Normal})$ $(1.75 \text{ GHz} \leq f \leq 3 \text{ GHz}, \text{ Frequency band mode: Spurious})$ $(3 \text{ GHz} < f \leq 6.75 \text{ GHz})$
	≤ -70 dBc	$\geq +60$ dBm	
	≤ -70 dBc	$\geq +60$ dBm	
with MS2830A-008, Preamp: On Preamp input level: -45 dBm			
	Harmonic distortion	SHI	$(10 \text{ MHz} \leq f \leq 300 \text{ MHz})$ $(300 \text{ MHz} < f \leq 3 \text{ GHz})$
	≤ -50 dBc	$\geq +5$ dBm	
	≤ -55 dBc	$\geq +10$ dBm	
SHI: Second Harmonic Intercept			
Residual Responses	Frequency: ≥ 1 MHz, Input attenuator: 0 dB, 50 Ω terminated with MS2830A-077/078, Except bandwidth setting: >31.25 MHz ≤ -100 dBm (up to 1 GHz) ≤ -90 dBm (typ., 1 GHz to 6 GHz) ≤ -90 dBm (nominal, 6 GHz to 13.5 GHz)		

Signal Analyzer MS2830A Specifications

Signal Analyzer/Spectrum Analyzer (Continued)

Connector

RF Input	Connector: N-J (Front panel), 50Ω (nominal) 18° to 28°C, Input attenuator: ≥10 dB VSWR (nominal): ≤1.2 (40 MHz ≤ f ≤ 3 GHz) ≤1.5 (3 GHz < f ≤ 6 GHz) ≤1.6 (6 GHz < f ≤ 13.5 GHz)
External Reference Input	Connector: BNC-J (Rear panel), 50Ω (nominal) Frequency: 5, 10, 13 MHz Operating range: ±1 ppm Input level: -15 to +20 dBm, 50Ω (AC coupling)
Reference Signal Output	Connector: BNC-J (Rear panel), 50Ω (nominal) Frequency: 10 MHz Output level: ≥0 dBm (AC coupling)
Sweep Status Output	Connector: BNC-J (Rear panel) Output level: TTL level (High level at sweeping or waveform capture)
SA Trigger Input	Connector: BNC-J (Rear panel) Output level: TTL level
Noise Source Drive	This is available when the MS2830A-017/117 is installed. Supply (+28 V) of the Noise Source Drive. Rear Panel, BNC-J Output Voltage: 28 ±0.5 V, Pulsed
External Controller	Control from external controller (excluding power-on/off)
Ethernet (10/100/1000BASE-T)	Connector: RJ-45 (Rear panel)
GPIB	IEEE488 bus connector (IEEE488.2, Rear panel) Interface function: SH1, AH1, T6, L4, SR1, RL1, PP0, DC1, DT0, C0, E2
USB (B)	USB-B connector (USB2.0, Rear panel)
USB	USB-A connector (USB2.0, Front panel: 2 ports, Rear panel: 2 ports)
Monitor Output	Mini D-Sub 15 pin (Compatible with VGA, Rear panel)
Aux	50 pin (Correspond to DX10A-50S, Rear panel), Using extended input/output
Display	XGA-color LCD (Resolution: 1024 × 768), 8.4 inches (Diagonal: 213 mm)

General

Dimensions and Mass	426 (W) × 177 (H) × 390 (D) mm (Exclusive of surface projection) ≤14.5 kg (with MS2830A-040/041, and MS2830A-020/021, excluding other options) ≤13.5 kg (with MS2830A-043, excluding other options)	
Power Supply	Power voltage: 100 V(ac) to 120 V(ac) / 200 V(ac) to 240 V(ac) (-15/+10%, Except 250 V max.) Frequency: 50 Hz/60 Hz Power consumption: ≤350 VA (including all options) 110 VA (nominal, with MS2830A-040/041, excluding other options) 130 VA (nominal, with MS2830A-043, excluding other options) 170 VA (nominal, with MS2830A-040/041, MS2830A-020/021, and MS2830A-022, excluding other options) 190 VA (nominal, with MS2830A-043, MS2830A-020/021, and MS2830A-022, excluding other options)	
Temperature Range	Operating: +5° to +45°C Storage: -20° to +60°C	
CE	EMC	EN61326-1, EN61000-3-2
	LVD	EN61010-1
	RoHS	EN50581
Vibration	MIL-STD-810D	
Shock	MIL-T-28800E	

Signal Analyzer MS2830A Specifications

Spectrum Analyzer

Frequency

Span	Range: 0 Hz, 300 Hz to 3.6 GHz [MS2830A-040] 0 Hz, 300 Hz to 6 GHz [MS2830A-041] 0 Hz, 300 Hz to 13.5 GHz [MS2830A-043] Resolution: 2 Hz Accuracy: $\pm 0.2\%$ (Sweep points: 10001)
Frequency Readout Accuracy	$\pm (\text{Display frequency} \times \text{Frequency reference accuracy} + \text{Span frequency} \times \text{Span accuracy} + \text{RBW} \times 0.05 + 2 \times N + \text{Span frequency}/(\text{Sweep points}-1))\text{Hz}$ N: Mixer harmonic order
Resolution Bandwidth (RBW)	Setting range: 1 Hz to 3 MHz (1-3 sequence), 500 Hz, 50 kHz, 2 MHz, 5 MHz, 10 MHz, 20 MHz, 31.25 MHz 1 Hz to 10 Hz: Can not be set when Span: 0 Hz 31.25 MHz: Can be set when Span: 0 Hz only 20 MHz, 31.25 MHz: Can be set when with MS2830A-005 200 Hz (6 dB), 9 kHz (6 dB), 120 kHz (6 dB), 1 MHz (Impulse) (with MS2830A-016) Selectivity ($-60 \text{ dB}/-3 \text{ dB}$): 4.5:1 (nominal, 1 Hz to 10 MHz)
Video Bandwidth (VBW)	1 Hz to 3 kHz (1-3 sequence), 5 kHz, 10 kHz to 10 MHz (1-3 sequence), Off VBW mode: Video average, Power average

Amplitude

Displayed Average Noise Level (DANL)	<p>18° to 28°C, Detector: Sample, VBW: 1 Hz (Video average), Input attenuator: 0 dB without MS2830A-062/066, without MS2830A-008, or Preamp: Off</p> <ul style="list-style-type: none"> -120 dBm/Hz (9 kHz \leq f < 100 kHz, nominal) -134 dBm/Hz (100 kHz) -134 dBm/Hz (100 kHz < f < 1 MHz, nominal) -144 dBm/Hz (1 MHz) -144 dBm/Hz (1 MHz < f < 10 MHz, nominal) -150 dBm/Hz (10 MHz \leq f < 30 MHz, nominal) -153 dBm/Hz (30 MHz \leq f < 1 GHz) -151 dBm/Hz (1 GHz \leq f < 2.4 GHz) -149 dBm/Hz (2.4 GHz \leq f \leq 3.5 GHz) -146 dBm/Hz (3.5 GHz < f \leq 6 GHz) [MS2830A-041/043] -142 dBm/Hz (6 GHz < f \leq 13.5 GHz) [MS2830A-043] <p>without MS2830A-062/066, with MS2830A-008, Preamp: On</p> <ul style="list-style-type: none"> -147 dBm/Hz (100 kHz, nominal) -156 dBm/Hz (1 MHz) -163 dBm/Hz (30 MHz \leq f < 1 GHz) -162 dBm/Hz (1 GHz \leq f < 2 GHz) -160 dBm/Hz (2 GHz \leq f \leq 3.5 GHz) -157 dBm/Hz (3.5 GHz < f \leq 4 GHz, Frequency band mode: Normal) [MS2830A-041/043] -157 dBm/Hz (3.5 GHz < f \leq 4 GHz, Frequency band mode: Spurious) [MS2830A-041/043] -157 dBm/Hz (4 GHz < f \leq 6 GHz) [MS2830A-041/043] <p>with MS2830A-062/066 and inactive, without MS2830A-008, or Preamp: Off</p> <ul style="list-style-type: none"> -120 dBm/Hz (9 kHz \leq f < 100 kHz, nominal) -133 dBm/Hz (100 kHz) -133 dBm/Hz (100 kHz < f < 1 MHz, nominal) -143 dBm/Hz (1 MHz) -143 dBm/Hz (1 MHz < f < 10 MHz, nominal) -149 dBm/Hz (10 MHz \leq f < 30 MHz, nominal) -152 dBm/Hz (30 MHz \leq f < 1 GHz) -150 dBm/Hz (1 GHz \leq f < 2.4 GHz) -147 dBm/Hz (2.4 GHz \leq f \leq 3.5 GHz) -144 dBm/Hz (3.5 GHz < f \leq 6 GHz) [MS2830A-041/043] -142 dBm/Hz (6 GHz < f \leq 13.5 GHz) [MS2830A-043] <p>with MS2830A-062/066 and active, without MS2830A-008, or Preamp: Off</p> <ul style="list-style-type: none"> -133 dBm/Hz (100 kHz) -143 dBm/Hz (1 MHz) -152 dBm/Hz (30 MHz \leq f < 1 GHz) -150 dBm/Hz (1 GHz \leq f < 2.4 GHz) -147 dBm/Hz (2.4 GHz \leq f \leq 3.5 GHz) -144 dBm/Hz (3.5 GHz < f \leq 6 GHz) [MS2830A-041/043] -142 dBm/Hz (6 GHz < f \leq 13.5 GHz) [MS2830A-041/043] <p>with MS2830A-062/066, with MS2830A-008, Preamp: On</p> <ul style="list-style-type: none"> -146 dBm/Hz (100 kHz, nominal) -155 dBm/Hz (1 MHz) -162 dBm/Hz (30 MHz \leq f < 1 GHz) -161 dBm/Hz (1 GHz \leq f < 2 GHz) -158 dBm/Hz (2 GHz \leq f \leq 3.5 GHz) -154 dBm/Hz (3.5 GHz < f \leq 4 GHz, Frequency band mode: Normal) [MS2830A-041/043] -154 dBm/Hz (3.5 GHz < f \leq 4 GHz, Frequency band mode: Spurious) [MS2830A-041/043] -154 dBm/Hz (4 GHz < f \leq 6 GHz) [MS2830A-041/043]
--------------------------------------	---

Signal Analyzer MS2830A Specifications

Spectrum Analyzer (Continued)

Total Absolute Amplitude Accuracy*	18° to 28°C, after CAL, Auto sweep time select: Normal, 30 Hz ≤ RBW ≤ 1 MHz, Detector: Positive, CW Excluding the noise floor effect, and FFT runtime (Display: On) without MS2830A-008, or Preamp: Off Input attenuator: ≥10 dB, Mixer input level: ≤-10 dBm ±0.5 dB (300 kHz ≤ f < 4 GHz, Frequency band mode: Normal) (300 kHz ≤ f < 3.5 GHz, Frequency band mode: Spurious) ±1.8 dB (4 GHz ≤ f ≤ 6 GHz, Frequency band mode: Normal) (3.5 GHz ≤ f ≤ 6 GHz, Frequency band mode: Spurious) ±1.8 dB (6 GHz < f ≤ 13.5 GHz) with MS2830A-008, Preamp: On Input attenuator: 10 dB, Preamp input level: -30 dBm ±1.0 dB (300 kHz ≤ f < 4 GHz, Frequency band mode: Normal) (300 kHz ≤ f < 3.5 GHz, Frequency band mode: Spurious) ±1.8 dB (4 GHz ≤ f ≤ 6 GHz, Frequency band mode: Normal) (3.5 GHz ≤ f ≤ 6 GHz, Frequency band mode: Spurious)
------------------------------------	--

*: Total absolute amplitude accuracy is found from root sum of squares (RSS) of RF frequency characteristics, Linearity error, and Input attenuator switching uncertainty.

Spurious Responses

2-tone 3rd-order Intermodulation Distortion	18° to 28°C, ≥300 kHz separation without MS2830A-008, or Preamp: Off Mixer input level: -15 dBm (1wave) ≤-54 dBc, TOI = +12 dBm (30 MHz ≤ f < 300 MHz) ≤-60 dBc, TOI = +15 dBm (300 MHz ≤ f < 3.5 GHz) ≤-58 dBc, TOI = +14 dBm (3.5 GHz ≤ f ≤ 6 GHz) ≤-50 dBc, TOI = +10 dBm (6 GHz < f ≤ 13.5 GHz) with MS2830A-008, Preamp: On Preamp input level: -45 dBm (1wave) ≤-73 dBc, TOI = -8.5 dBm (30 MHz ≤ f < 300 MHz) ≤-78 dBc, TOI = -6 dBm (300 MHz ≤ f ≤ 700 MHz) ≤-81 dBc, TOI = -4.5 dBm (700 MHz ≤ f < 4 GHz, Frequency band mode: Normal) (700 MHz ≤ f < 3.5 GHz, Frequency band mode: Spurious) ≤-78 dBc, TOI = -6 dBm (4 GHz ≤ f ≤ 6 GHz, Frequency band mode: Normal) (3.5 GHz ≤ f ≤ 6 GHz, Frequency band mode: Spurious) TOI: Third-order intermodulation distortion
Image Responses	Frequency band mode: Normal ≤-70 dBc (10 MHz ≤ f < 4 GHz) ≤-55 dBc (4 GHz ≤ f ≤ 6 GHz) ≤-60 dBc (6 GHz < f ≤ 13.5 GHz)

Sweep

Sweep Mode	Continuous, Single
Sweep Time	Setting range: 1 ms to 1000 s (Span: ≥300 Hz) 1 μs to 1000 s (Span: 0 Hz)

Waveform Display

Detector	Positive & Negative, Positive peak, Sample, Negative peak, RMS Quasi-Peak, CISPR-AVG, RMS-AVG (with MS2830A-016)
Sweep (trace) Point	1001, 2001, 5001, 10001 (Span: >500 MHz) 101, 201, 251, 401, 501, 1001, 2001, 5001, 10001 (100 MHz < Span ≤ 500 MHz) (300 Hz ≤ Span ≤ 100 MHz, Sweep time: > 10 s) 11, 21, 41, 51, 101, 201, 251, 401, 501, 1001, 2001, 5001, 10001 (300 Hz ≤ Span ≤ 100 MHz, Sweep time: ≤ 10 s) (Span: 0 Hz)
Scale	Log scale: 10 div/12 div, 0.1 to 20 dB/div (1-2-5 sequence) Linear scale: 10 div, 1 to 10%/div (1-2-5 sequence)
Trigger	Free run (Trigger off), Video, Wide IF video, External, Frame SG Marker (with MS2830A-020/021)
Gate	Off, Wide IF video, External, Frame SG Marker (with MS2830A-020/021)

Measure Function

Adjust Channel Power (ACP)	Reference: Span total, Carrier total, Both sides of carriers, Carrier select Adjust channel specifications: 3 channels × 2 (Normal mode), 8 channels × 2 (Advanced mode)
Burst Average Power	Displayed average power of specified interval at time domain
Channel Power	Measurement of absolute values: dBm, dBm/Hz
Occupied Bandwidth (OBW)	N% of power, X-dB down
Spectrum Emission Mask (SEM)	Decision to Pass/Fail at Peak/Margin measurement
Spurious Emission	Decision to Pass/Fail at Worst/Peaks measurement
Frequency Counter	Accuracy Span: ≤1 MHz, RBW: 1 kHz, S/N: ≥50 dB, Gate time: ≥100 ms ± (Marker frequency × Frequency reference accuracy + (0.1 × N / Gate time [s]) Hz) N: Mixer harmonic order
	Gate Time Setting 100 μs to 1 s
2-tone 3rd-order Intermodulation Distortion	Measures IM3 and TOI from two-tone signal.

Signal Analyzer MS2830A Specifications

Signal Analyzer

Display waveform data, such as Spectrum, Power vs. Time captured at specific time

General

Trace Mode	Spectrum, Power vs. Time, Frequency vs. Time, Phase vs. Time, CCDF, Spectrogram, No Trace
Analysis Bandwidth	Sets capture analysis bandwidth from center frequency 1 kHz to 10 MHz (1-2.5-5 sequence) (with MS2830A-006) 1 kHz to 25 MHz (1-2.5-5 sequence), 31.25 MHz (with MS2830A-005) 1 kHz to 25 MHz (1-2.5-5 sequence), 31.25 MHz, 50 MHz, 62.5 MHz (with MS2830A-077) 1 kHz to 25 MHz (1-2.5-5 sequence), 31.25 MHz, 50 MHz, 62.5 MHz, 100 MHz, 125 MHz (with MS2830A-078)
Sampling Rate	Auto setting by conditions of analysis bandwidth 2 kHz to 20 MHz (1-2-5 sequence) (with MS2830A-006) 2 kHz to 50 MHz (1-2-5 sequence) (with MS2830A-005) 2 kHz to 100 MHz (1-2-5 sequence) (with MS2830A-077) 2 kHz to 200 MHz (1-2-5 sequence) (with MS2830A-078)
Capture Time	without MS2830A-077/078, or ≤ 31.25 MHz bandwidth Setting capture time length Minimum capture time length: 2 μ s to 50 ms (Determined according to analysis bandwidth) Maximum capture time length: 2 s to 2000 s (Determined according to analysis bandwidth) Setting mode: Auto, Manual with MS2830A-077, > 31.25 MHz bandwidth Setting capture time length Minimum capture time length: 1 μ s Maximum capture time length: 500 ms Setting mode: Auto, Manual with MS2830A-078, > 31.25 MHz bandwidth Setting capture time length Minimum capture time length: 500 ns to 1 μ s (Determined according to analysis bandwidth) Maximum capture time length: 500 ms Setting mode: Auto, Manual
Trigger	Free run (Trigger off), Video, Wide IF video, Frame, External (TTL) SG Marker (with MS2830A-020/021)
ADC Resolution	without MS2830A-077/078, or ≤ 31.25 MHz bandwidth 16 bits

Spectrum Displayed Function

Function Outline	Displayed spectrum of any time length and frequency range within captured waveform data
Analysis Time Length	Analysis start time: Sets analysis start time point from waveform data header Analysis time length: Sets analysis time length Setting mode: Auto, Manual
Frequency	Can be set Center frequency and Span at frequency range in waveform data
Frequency Setting	without MS2830A-077/078, or ≤ 31.25 MHz bandwidth 0 MHz to 3.6 GHz [MS2830A-040] 0 MHz to 6 GHz [MS2830A-041] 0 MHz to 13.5 GHz [MS2830A-043] with MS2830A-077/078, > 31.25 MHz bandwidth 300 MHz to 3.6 GHz [MS2830A-040] 300 MHz to 6 GHz [MS2830A-041] 300 MHz to 13.5 GHz [MS2830A-043]
Resolution Bandwidth (RBW)	without MS2830A-077/078, or ≤ 31.25 MHz bandwidth Setting range: 1 Hz to 1 MHz (1-3 sequence) Selectivity (-60 dB/-3 dB): 4.5:1 (nominal) with MS2830A-077, > 31.25 MHz bandwidth Setting range: 1 Hz to 3 MHz (1-3 sequence) Selectivity (-60 dB/-3 dB): 4.5:1 (nominal) with MS2830A-078, > 31.25 MHz bandwidth Setting range: 1 Hz to 10 MHz (1-3 sequence) Selectivity (-60 dB/-3 dB): 4.5:1 (nominal)
Total Absolute Amplitude Accuracy*	18° to 28°C, after CAL, Input attenuator: ≥ 10 dB, RBW: Auto, Time detection: Average, Marker result: Integration or Peak (Accuracy), Center frequency, CW Excluding the noise floor effect without MS2830A-008, or Preamp: Off Input attenuator: ≥ 10 dB, Mixer input level: ≤ -10 dBm ± 0.5 dB (300 kHz $\leq f < 4$ GHz, Frequency band mode: Normal) ± 1.8 dB (300 kHz $\leq f < 3.5$ GHz, Frequency band mode: Spurious) ± 1.8 dB (4 GHz $\leq f \leq 6$ GHz, Frequency band mode: Normal) ± 1.8 dB (3.5 GHz $\leq f \leq 6$ GHz, Frequency band mode: Spurious) ± 1.8 dB (6 GHz $< f \leq 13.5$ GHz) with MS2830A-008, Preamp: On Input attenuator: 10 dB, Preamp input level: ≤ -30 dBm ± 1.0 dB (300 kHz $\leq f < 4$ GHz, Frequency band mode: Normal) ± 1.8 dB (300 kHz $\leq f < 3.5$ GHz, Frequency band mode: Spurious) ± 1.8 dB (4 GHz $\leq f \leq 6$ GHz, Frequency band mode: Normal) ± 1.8 dB (3.5 GHz $\leq f \leq 6$ GHz, Frequency band mode: Spurious)

*: Total absolute amplitude accuracy is found from root sum of squares (RSS) of RF frequency characteristics, Linearity error, and Input attenuator switching uncertainty.

Signal Analyzer MS2830A Specifications

Signal Analyzer (Continued)

In-band Frequency Characteristics	18° to 28°C, Referenced to level at center frequency, Center frequency: ±10 MHz without MS2830A-077/078, or ≤31.25 MHz bandwidth ±0.31 dB (30 MHz ≤ f ≤ 4 GHz, Frequency band mode: Normal) (30 MHz ≤ f < 3.5 GHz, Frequency band mode: Spurious)
Displayed Average Noise Level (DANL)	18° to 28°C, Input attenuator: 0 dB without MS2830A-062/066, without MS2830A-008, or Preamp: Off -131.5 dBm/Hz (100 kHz) -141.5 dBm/Hz (1 MHz) -150.5 dBm/Hz (30 MHz ≤ f < 1 GHz) -148.5 dBm/Hz (1 GHz ≤ f < 2.4 GHz) -146.5 dBm/Hz (2.4 GHz ≤ f ≤ 3.5 GHz) -143.5 dBm/Hz (3.5 GHz < f ≤ 6 GHz) [MS2830A-041/043] -139.5 dBm/Hz (6 GHz < f ≤ 13.5 GHz) [MS2830A-043] without MS2830A-062/066, with MS2830A-008, Preamp: On -144.5 dBm/Hz (100 kHz, nominal) -153.5 dBm/Hz (1 MHz) -160.5 dBm/Hz (30 MHz ≤ f < 1 GHz) -159.5 dBm/Hz (1 GHz ≤ f < 2 GHz) -157.5 dBm/Hz (2 GHz ≤ f ≤ 3.5 GHz) -154.5 dBm/Hz (3.5 GHz < f ≤ 4 GHz, Frequency band mode: Normal) [MS2830A-041/043] -154.5 dBm/Hz (3.5 GHz < f ≤ 4 GHz, Frequency band mode: Spurious) [MS2830A-041/043] -154.5 dBm/Hz (4 GHz < f ≤ 6 GHz) [MS2830A-041/043] with MS2830A-062/066, without MS2830A-008, or Preamp: Off -130.5 dBm/Hz (100 kHz) -140.0 dBm/Hz (1 MHz) -149.5 dBm/Hz (30 MHz ≤ f < 1 GHz) -147.0 dBm/Hz (1 GHz ≤ f < 2.4 GHz) -144.5 dBm/Hz (2.4 GHz ≤ f ≤ 3.5 GHz) -141.5 dBm/Hz (3.5 GHz < f ≤ 6 GHz) [MS2830A-041/043] -139.5 dBm/Hz (6 GHz < f ≤ 13.5 GHz) [MS2830A-043] with MS2830A-062/066, with MS2830A-008, Preamp: On -143.5 dBm/Hz (100 kHz, nominal) -152.5 dBm/Hz (1 MHz) -159.5 dBm/Hz (30 MHz ≤ f < 1 GHz) -158.5 dBm/Hz (1 GHz ≤ f < 2 GHz) -155.5 dBm/Hz (2 GHz ≤ f ≤ 3.5 GHz) -151.5 dBm/Hz (3.5 GHz < f ≤ 4 GHz, Frequency band mode: Normal) [MS2830A-041/043] -151.5 dBm/Hz (3.5 GHz < f ≤ 4 GHz, Frequency band mode: Spurious) [MS2830A-041/043] -151.5 dBm/Hz (4 GHz < f ≤ 6 GHz) [MS2830A-041/043]
Adjacent Channel Power (ACP)	Reference: Span total, Carrier total, Both sides of carriers, Carrier select Adjacent channel specifications: 3 channels × 2
Channel Power	Measurement of absolute values: dBm, dBm/Hz
Occupied Bandwidth (OBW)	N% of Power, X-dB Down

Power vs. Time Displayed Function

Function Outline	Displayed time changes of power for captured waveform data
Analysis Time Range	Analysis start time: Sets analysis start time position from beginning of waveform data Analysis time length: Sets analysis time length Setting mode: Auto, Manual
Resolution Bandwidth	Filter type: Rect, Gaussian, Nyquist, Root Nyquist, Off, (Default: Off) Roll-off ratio: 0.01 to 1 (Set for Nyquist, Root Nyquist) Filter frequency offset: Set center frequency of filter in wavelength data frequency band
AM Depth (Peak to Peak Measurement)	Measures with AM depth or marker function +Peak, -Peak, (P-P)/2, Average
Burst Average Power	Measures average power of burst signal

Frequency vs. Time Displayed Function

Function Outline	Displayed frequency time fluctuations of input signal from captured waveform data
Analysis Time Range	Analysis start time: Sets analysis start time point from waveform data header Analysis time length: Sets analysis time length Setting mode: Auto, Manual
Operating Level Range	-17 to +30 dBm (Input attenuator: ≥10 dB)
Frequency (Vertical axis)	Can be set Center frequency and Span at frequency range in waveform data Displayed frequency range: Selectable 1/25, 1/10, 1/5, 1/2 of analysis bandwidth Input frequency range: 10 MHz to 6 GHz
Frequency Readout Accuracy	Input level: -17 to +30 dBm, Span: ≤31.25 MHz, Scale: Span/25, CW input ± (Reference oscillator accuracy × Center frequency + Displayed frequency range × 0.01) Hz
FM Deviation (Peak to Peak Measurement)	Measures FM deviation or marker function +Peak, -Peak, (P-P)/2, Average

Signal Analyzer MS2830A Specifications

Signal Analyzer (Continued)

Phase vs. Time Displayed Function

Function Outline	Displayed phase time fluctuation of input signal from captured waveform data
Analysis Time Range	Analysis start time: Sets analysis start time point from waveform data header Analysis time length: Sets analysis time length Setting mode: Auto, Manual
Phase (Vertical Axis)	Display mode: Wrap, Unwrap Displayed phase range: 0.01 deg./div to 200 Gdeg./div Offset: -100 deg. to +100 Mdeg.

CCDF/APD Displayed Function

Function Outline	Displayed CCDF and APD of waveform data within a given length of time
Analysis Time Range	Analysis start time: Sets analysis start time point from waveform data header Analysis time length: Sets analysis time length Setting mode: Auto, Manual
Display	Displayed CCDF or APD as graphs Histogram resolution: 0.01 dB Value: Average power, Max. power, Crest factor
Resolution Bandwidth	Filter type: Rectangle, Off, (Default: Off) Filter frequency offset: Sets filter center frequency in frequency band of waveform data

Spectrogram Displayed Function

Function Outline	Displayed spectrogram for arbitrary time length in captured waveform data
Analysis Time Range	Analysis start time: Sets analysis start time point from waveform data header Analysis time length: Sets analysis time length Setting mode: Auto, Manual
Frequency	Can be set Center frequency and Span at frequency range in waveform data
Resolution Bandwidth (RBW)	Setting range: 1 Hz to 1 MHz (1-3 sequence) Selectivity (-60 dB/-3 dB): 4.5:1 (nominal)

Digitize Function

Function Outline	Captured waveform data saved to internal HDD or output to external devices
Waveform Data	Format: I, Q (each 32 bit, Float binary type) Level: 0 dBm input is $\sqrt{I^2 + Q^2} = 1$ Level accuracy: Same as signal analyzer absolute amplitude accuracy
External Output	Can be output to external PC via Ethernet

Replay Function

Function Outline	Captured waveforms can be replayed again by using the VSA function to read saved digitize data		
Conditions for Measurable Waveform Data	Format: I, Q (binary format)		
	Combination of Span, Sampling rate, and Minimum capture sample		
	Span	Sampling Rate	Minimum Capture Sample
	1 kHz	2 kHz	74000 (37 s)
	2.5 kHz	5 kHz	160000 (32 s)
	5 kHz	10 kHz	310000 (31 s)
	10 kHz	20 kHz	610000 (30.5 s)
	25 kHz	50 kHz	730000 (14.6 s)
	50 kHz	100 kHz	730000 (7.3 s)
	100 kHz	200 kHz	730000 (3.65 s)
	250 kHz	500 kHz	730000 (1.46 s)
	500 kHz	1 MHz	730000 (730 ms)
	1 MHz	2 MHz	730000 (365 ms)
	2.5 MHz	5 MHz	730000 (146 ms)
	5 MHz	10 MHz	730000 (73 ms)
	10 MHz	20 MHz	730000 (36.5 ms)
	18.6 MHz	20 MHz	730000 (36.5 ms)
	20 MHz	25 MHz	730000 (29.2 ms)
	25 MHz	50 MHz	730000 (14.6 ms)
31.25 MHz	50 MHz	730000 (14.6 ms)	
50 MHz	100 MHz	730000 (7.3 ms)	
62.5 MHz	100 MHz	730000 (7.3 ms)	
100 MHz	200 MHz	730000 (3.65 ms)	
125 MHz	200 MHz	730000 (3.65 ms)	

Signal Analyzer MS2830A Specifications

Noise Figure Measurement Function*1 MS2830A-017

Frequency

Frequency Range	MS2830A-040: 30 MHz to 3.6 GHz MS2830A-041: 30 MHz to 6 GHz MS2830A-043: 30 MHz to 13.5 GHz
Frequency Setting Range	MS2830A-040: 10 MHz to 3.6 GHz MS2830A-041: 10 MHz to 6 GHz MS2830A-043: 10 MHz to 13.5 GHz

NF Measurement

Within the measurement range,
Attenuator = 0 dB*2

Measurement Range	- 20 to +40 dB
Instrument Uncertainty	ENR: 4 to 7 dB ± 0.02 dB ENR: 12 to 17 dB ± 0.025 dB ENR: 20 to 22 dB ± 0.03 dB

Gain Measurement

Measurement Range	Within the frequency range -20 to +40 dB
Instrument Uncertainty	Within the measurement range ≤ 0.07

Resolution Bandwidth

Setting Range	100 kHz to 8 MHz
---------------	------------------

Connector

Noise Source	Connector: Rear Panel, BNC-J Output Voltage: 28 ± 0.5 V, Pulsed
--------------	--

*1: Recommending the NC346 Series noise sources by Noisecom company

*2: Recommend to use Pre Amp

Signal Analyzer MS2830A Specifications

MS2830A-018 Audio Analyzer

The Audio Analyzer is used in combination with the MX269018A Analog Measurement Software.

Audio Analyzer Function

The specifications for single tone measurement

Measurement Function	Amplitude, Frequency, THD, THD + N, SINAD
Connector	Balanced: 1/4-inch phone jack (3-pole, $\Phi 6.3$ mm) Unbalanced: BNC-J
Impedance	Balanced: 200k Ω (AC coupled, nominal) Unbalanced: 100k Ω (AC coupled, nominal)
Frequency Measurement Range	20 Hz to 50 kHz
Level Measurement Range	1 mV rms to 25 V rms (30 V rms max.)
Input Range Setting	50 mV peak, 500 mV peak, 5 V peak, 50 V peak
Level Accuracy	18° to 28°C ± 0.4 dB (20 Hz $\leq f \leq 25$ kHz) ± 3.0 dB (25 kHz $< f \leq 50$ kHz)
THD + N (Total Harmonic Distortion + Noise)	At 1 kHz, 1.4 V rms, Band: 20 Hz to 20 kHz, Range: 5 Vp-p, 18° to 28°C < -60 dB < -80 dB (nominal)
Audio Filter	LPF: Off, 3, 15, 20, 30, 50 kHz HPF: Off, 20, 50, 100, 300, 400 Hz, 30 kHz BPF (Weighting filter): Off, CCITT, C-Message, CCIR468, CCIR-ARM, A-Weighting

Audio Generator Function

The specifications for all single-tone measurements except White Noise (through ITU-T G.227 filter)

Connector Type	Balanced: 1/4-inch phone jack (3-pole, $\Phi 6.3$ mm) Unbalanced: BNC-J	
Impedance	Balanced: 100 Ω /600 Ω (AC coupled, nominal) Unbalanced: 50 Ω /600 Ω (AC coupled, nominal)	
Output Waveform	Single tone Multi tone: Tone $\times 3$, DCS, White noise (ITU-T G.227), DTMF	
Guaranteed Frequency Range	20 Hz to 25 kHz	
Frequency Setting Range	10 Hz to 50 kHz	
Frequency Resolution	0.01 Hz	
Output Level Range	Using Sub Supply/Audio Revision 2*1 Single tone	
	Open circuit voltage (≥ 100 k Ω termination)	Balanced Off, 1 mV rms to 12.4 V rms Unbalanced Off, 1 mV rms to 6.2 V rms
	600 Ω termination*	Balanced Off, -63 dBm (equivalent to 0.5 mV rms) to +18 dBm (equivalent to 6.2 V rms) Unbalanced Off, -63 dBm (equivalent to 0.5 mV rms) to +12 dBm (equivalent to 3.1 V rms)
	White noise (through ITU-T G.227 filter)	
	Open circuit voltage (≥ 100 k Ω termination)	Balanced Off, 1.545 mV rms to 3.083 V rms (nominal) Unbalanced Off, 1.545 mV rms to 1.545 V rms (nominal)
	600 Ω termination*	Balanced Off, -60 dBm (equivalent to 0.774 mV rms) to +6 dBm (equivalent to 1.545 V rms) (nominal) Unbalanced Off, -60 dBm (equivalent to 0.774 mV rms) to 0 dBm (equivalent to 0.774 V rms) (nominal)
*: Output Impedance = 600 Ω , and Output Impedance Reference = 600 Ω		
Output Level Resolution	Single tone: 1 mV (350 mV rms < Output Level \leq 6.2 V rms) 100 μ V (35 mV rms < Output Level \leq 350 mV rms) 10 μ V (Output Level \leq 35 mV rms) White noise (through ITU-T G.227 filter): 0.01 dB (nominal)	
Level Accuracy	Single tone: ± 0.3 dB (1 kHz, 100k Ω termination, 18° to 28°C) White noise (through ITU-T G.227 filter): ± 3 dB	
Maximum Output Current	100 mA (nominal, no short circuit)	
THD + N (Total Harmonic Distortion + Noise)	At 1 kHz, 0.7 V rms, Band: 20 Hz to 25 kHz, 100k Ω termination, 18° to 28°C < -60 dB < -80 dB (nominal)	

Other Functions

Demodulation Output (FM only)*2	Connector: BNC-J Level: -10 dBm ± 2 dB (Frequency Deviation = 3.5 kHz, 600 Ω) Impedance: 600 Ω Sound Monitor: Internal speaker or 3.5 mm phone jack (2-pole, monaural)
Others	Crosstalk: Crosstalk from Audio Generator to Audio Analyzer >80 dB Push To Talk (PTT) Control Connector: Banana jack ($\Phi 4.0$ mm, 30 V max., 500 mA max.) General Input/Output (Audio Function) Connector: D-Sub 15 pin (jack) Function: Open Collector $\times 1$ (5 V, 100 mA max.), TTL Output $\times 2$, TTL Input $\times 2$

*1: Sub Supply/Audio Revision is the MS2830A-018/118 printed-circuit board version.

<Sub Supply/Audio Revision Confirmation Method>

(1) MS2830A units with Sub Supply/Audio Revision 2 have a sticker marked 'A1' next to the main-frame serial number.

(2) The MS2830A Sub Supply/Audio Revision can be confirmed as follows:

Press [System Config] \rightarrow [F5] System Information \rightarrow [F4] Board Revision View to list the Board Revisions; check the displayed Sub Supply/Audio Revision number. (It may be either 1 or 2.)

*2: For Tx test of analog wireless equipment. Wide FM measurements not supported.

Signal Analyzer MS2830A Specifications

3.6 GHz Vector Signal Generator MS2830A-020/6 GHz Vector Signal Generator MS2830A-021

✦: Use the MS2830A-021 for frequencies higher than 3.6 GHz.
Available to use for signal source of Internal Signal Generator Control Function MS2830A-052.

The specifications of the MS2830A-020/021 are defined under the following conditions unless otherwise specified.

CW	Pulse modulation: Off
Modulation	after CAL Waveform pattern RMS value: At RMSw (linear value) and each combination less than following ranges: RMSnom = 20 • log (RMSw/4628) [16-bit data] RMSnom = 20 • log (RMSw/2314) [15-bit data] RMSnom = 20 • log (RMSw/1157) [14-bit data] -3.00 dB ≤ RMSnom ≤ +3.00 dB Pulse modulation: Off

Frequency

Range	250 kHz to 3.6 GHz [MS2830A-020] 250 kHz to 6 GHz [MS2830A-021]
Resolution	0.01 Hz steps

Above specifications also apply under MS2830A-052 working.

Output Level

Setting Range	without MS2830A-022 -40 to +20 dBm (>25 MHz), -40 to +2 dBm (≤25 MHz) with MS2830A-022 -136 to +15 dBm (>25 MHz), -136 to -3 dBm (≤25 MHz)																												
Units	dBm, dBμV (terminated, open)																												
Resolution	0.01 dB																												
Output Level Accuracy	18° to 28°C, CW without MS2830A-022 <table border="1"> <thead> <tr> <th></th> <th>Output level [p] (dBm)</th> </tr> </thead> <tbody> <tr> <td>±0.5 dB (typ., ≤25 MHz)</td> <td>-40 ≤ p ≤ +2</td> </tr> <tr> <td>±0.5 dB (typ., 25 MHz < f ≤ 375 MHz)</td> <td>-40 ≤ p ≤ +9</td> </tr> <tr> <td>±0.5 dB (375 MHz ≤ f ≤ 3.6 GHz)</td> <td>-40 ≤ p ≤ +9</td> </tr> <tr> <td>±0.8 dB (>3.6 GHz)</td> <td>-40 ≤ p ≤ +4</td> </tr> </tbody> </table> with MS2830A-022 <table border="1"> <thead> <tr> <th></th> <th>Output level [p] (dBm)</th> </tr> </thead> <tbody> <tr> <td>±1.0 dB (typ., ≤25 MHz)</td> <td>-110 ≤ p ≤ -3</td> </tr> <tr> <td>±1.0 dB (typ., 25 MHz < f < 100 MHz)</td> <td>-110 ≤ p ≤ +4</td> </tr> <tr> <td>±0.5 dB (typ., 100 MHz ≤ f < 375 GHz)</td> <td>-110 ≤ p ≤ +4</td> </tr> <tr> <td>±0.5 dB (375 MHz ≤ f ≤ 3.6 GHz)</td> <td>-110 ≤ p ≤ +4</td> </tr> <tr> <td>±0.8 dB (>3.6 GHz)</td> <td>-110 ≤ p ≤ -1</td> </tr> <tr> <td>±1.0 dB (100 MHz ≤ f ≤ 3.6 GHz)</td> <td>-120 ≤ p < -110</td> </tr> <tr> <td>±1.0 dB (typ., 100 MHz ≤ f ≤ 3.6 GHz)</td> <td>-127 ≤ p < -120</td> </tr> <tr> <td>±2.5 dB (typ., >3.6 GHz)</td> <td>-127 ≤ p < -110</td> </tr> </tbody> </table>		Output level [p] (dBm)	±0.5 dB (typ., ≤25 MHz)	-40 ≤ p ≤ +2	±0.5 dB (typ., 25 MHz < f ≤ 375 MHz)	-40 ≤ p ≤ +9	±0.5 dB (375 MHz ≤ f ≤ 3.6 GHz)	-40 ≤ p ≤ +9	±0.8 dB (>3.6 GHz)	-40 ≤ p ≤ +4		Output level [p] (dBm)	±1.0 dB (typ., ≤25 MHz)	-110 ≤ p ≤ -3	±1.0 dB (typ., 25 MHz < f < 100 MHz)	-110 ≤ p ≤ +4	±0.5 dB (typ., 100 MHz ≤ f < 375 GHz)	-110 ≤ p ≤ +4	±0.5 dB (375 MHz ≤ f ≤ 3.6 GHz)	-110 ≤ p ≤ +4	±0.8 dB (>3.6 GHz)	-110 ≤ p ≤ -1	±1.0 dB (100 MHz ≤ f ≤ 3.6 GHz)	-120 ≤ p < -110	±1.0 dB (typ., 100 MHz ≤ f ≤ 3.6 GHz)	-127 ≤ p < -120	±2.5 dB (typ., >3.6 GHz)	-127 ≤ p < -110
	Output level [p] (dBm)																												
±0.5 dB (typ., ≤25 MHz)	-40 ≤ p ≤ +2																												
±0.5 dB (typ., 25 MHz < f ≤ 375 MHz)	-40 ≤ p ≤ +9																												
±0.5 dB (375 MHz ≤ f ≤ 3.6 GHz)	-40 ≤ p ≤ +9																												
±0.8 dB (>3.6 GHz)	-40 ≤ p ≤ +4																												
	Output level [p] (dBm)																												
±1.0 dB (typ., ≤25 MHz)	-110 ≤ p ≤ -3																												
±1.0 dB (typ., 25 MHz < f < 100 MHz)	-110 ≤ p ≤ +4																												
±0.5 dB (typ., 100 MHz ≤ f < 375 GHz)	-110 ≤ p ≤ +4																												
±0.5 dB (375 MHz ≤ f ≤ 3.6 GHz)	-110 ≤ p ≤ +4																												
±0.8 dB (>3.6 GHz)	-110 ≤ p ≤ -1																												
±1.0 dB (100 MHz ≤ f ≤ 3.6 GHz)	-120 ≤ p < -110																												
±1.0 dB (typ., 100 MHz ≤ f ≤ 3.6 GHz)	-127 ≤ p < -120																												
±2.5 dB (typ., >3.6 GHz)	-127 ≤ p < -110																												
Output Level Linearity	18° to 28°C, CW without MS2830A-022, Referenced to -10 dBm output <table border="1"> <thead> <tr> <th></th> <th>Output level [p] (dBm)</th> </tr> </thead> <tbody> <tr> <td>±0.2 dB (typ., ≤3.6 GHz)</td> <td>-40 ≤ p ≤ -10</td> </tr> <tr> <td>±0.3 dB (typ., >3.6 GHz)</td> <td>-40 ≤ p ≤ -10</td> </tr> </tbody> </table> with MS2830A-022, Referenced to -15 dBm output <table border="1"> <thead> <tr> <th></th> <th>Output level [p] (dBm)</th> </tr> </thead> <tbody> <tr> <td>±0.2 dB (typ., ≤3.6 GHz)</td> <td>-110 ≤ p ≤ -15</td> </tr> <tr> <td>±0.3 dB (typ., >3.6 GHz)</td> <td>-110 ≤ p ≤ -15</td> </tr> </tbody> </table>		Output level [p] (dBm)	±0.2 dB (typ., ≤3.6 GHz)	-40 ≤ p ≤ -10	±0.3 dB (typ., >3.6 GHz)	-40 ≤ p ≤ -10		Output level [p] (dBm)	±0.2 dB (typ., ≤3.6 GHz)	-110 ≤ p ≤ -15	±0.3 dB (typ., >3.6 GHz)	-110 ≤ p ≤ -15																
	Output level [p] (dBm)																												
±0.2 dB (typ., ≤3.6 GHz)	-40 ≤ p ≤ -10																												
±0.3 dB (typ., >3.6 GHz)	-40 ≤ p ≤ -10																												
	Output level [p] (dBm)																												
±0.2 dB (typ., ≤3.6 GHz)	-110 ≤ p ≤ -15																												
±0.3 dB (typ., >3.6 GHz)	-110 ≤ p ≤ -15																												

Above specifications also apply under MS2830A-052 working.

Output Connector

Connector	N-J connector, 50Ω (Front panel, SG output)
VSWR	18° to 28°C without MS2830A-022, Output level ≤ -10 dBm 1.5 (≤3.6 GHz), 2.0 (>3.6 GHz) with MS2830A-022, Output level: ≤ -15 dBm 1.3 (≤3.6 GHz), 1.9 (>3.6 GHz)
Max. Reverse Input	0 Vdc (max.) without MS2830A-022 +12 dBm (<20 MHz), +24 dBm (≥20 MHz) with MS2830A-022 +18 dBm (<20 MHz), +30 dBm (≥20 MHz)

Above specifications also apply under MS2830A-052 working.

Signal Analyzer MS2830A Specifications

3.6 GHz Vector Signal Generator MS2830A-020/6 GHz Vector Signal Generator MS2830A-021 (Continued)

Signal Purity

Harmonic Spurious	Output level: ≤ 0 dBm (without MS2830A-022), ≤ -5 dBm (with MS2830A-022), CW < -30 dBc (≥ 1 MHz)
Non-Harmonic Spurious	Offset from output frequency: ≥ 15 kHz Output level: ≤ 0 dBm (without MS2830A-022), ≤ -5 dBm (with MS2830A-022), CW < -46 dBc ($100 \text{ MHz} \leq f \leq 3 \text{ GHz}$) < -40 dBc ($3 \text{ GHz} < f \leq 6 \text{ GHz}$)

Above specifications also apply under MS2830A-052 working.

Vector Modulation

Vector Accuracy	18° to 28°C, Output level: ≤ 0 dBm (without MS2830A-022), ≤ -5 dBm (with MS2830A-022) W-CDMA (DL 1 code), Output frequency: 800 MHz to 2.7 GHz LTE-DL (20 MHz), Output frequency: 600 MHz to 2.7 GHz $\leq 1.4\%$ (rms)												
Carrier Leak	18° to 28°C, RMS: 0 dB ≤ -40 dBc ($375 \text{ MHz} \leq f \leq 2.4 \text{ GHz}$)												
Image Rejection	18° to 28°C, use sine wave < 10 MHz ≤ -40 dBc												
ACLR	18° to 28°C, W-CDMA (Test Model 1 64DPCH) Output level: ≤ 0 dBm (without MS2830A-022), ≤ -5 dBm (with MS2830A-022)												
	<table border="1"> <thead> <tr> <th></th> <th>5 MHz offset</th> <th>10 MHz offset</th> </tr> </thead> <tbody> <tr> <td>$375 \text{ MHz} \leq f \leq 2.4 \text{ GHz}$</td> <td>$\leq -64$ dBc/3.84 MHz</td> <td>≤ -67 dBc/3.84 MHz</td> </tr> <tr> <td>$2.4 \text{ GHz} < f \leq 3.6 \text{ GHz}$</td> <td>$\leq -59$ dBc/3.84 MHz</td> <td>≤ -63 dBc/3.84 MHz</td> </tr> <tr> <td>$3.6 \text{ GHz} < f \leq 6 \text{ GHz}$</td> <td>$\leq -56$ dBc/3.84 MHz</td> <td>≤ -60 dBc/3.84 MHz</td> </tr> </tbody> </table>		5 MHz offset	10 MHz offset	$375 \text{ MHz} \leq f \leq 2.4 \text{ GHz}$	≤ -64 dBc/3.84 MHz	≤ -67 dBc/3.84 MHz	$2.4 \text{ GHz} < f \leq 3.6 \text{ GHz}$	≤ -59 dBc/3.84 MHz	≤ -63 dBc/3.84 MHz	$3.6 \text{ GHz} < f \leq 6 \text{ GHz}$	≤ -56 dBc/3.84 MHz	≤ -60 dBc/3.84 MHz
	5 MHz offset	10 MHz offset											
$375 \text{ MHz} \leq f \leq 2.4 \text{ GHz}$	≤ -64 dBc/3.84 MHz	≤ -67 dBc/3.84 MHz											
$2.4 \text{ GHz} < f \leq 3.6 \text{ GHz}$	≤ -59 dBc/3.84 MHz	≤ -63 dBc/3.84 MHz											
$3.6 \text{ GHz} < f \leq 6 \text{ GHz}$	≤ -56 dBc/3.84 MHz	≤ -60 dBc/3.84 MHz											
CW and Level Error at Vector Modulation	18° to 28°C, Bandwidth: 5 MHz (AWGN), Output frequency: ≥ 100 MHz Output level: ≤ 0 dBm (without MS2830A-022), ≤ -5 dBm (with MS2830A-022) ± 0.2 dB												

Pulse Modulation

On/Off Ratio	> 60 dB (≤ 3 GHz) > 40 dB ($3 \text{ GHz} < f \leq 6 \text{ GHz}$)
Rising/Falling Edge Time	≤ 90 ns (10% to 90%)
Pulse Repetition Frequency	DC to 1 MHz (Duty: 50%)
External Panel Modulation Signal Input	Aux connector (Rear panel), TTL H: Signal On, L: Signal Off

Arbitrary Waveform Generator

Waveform Resolution	14/15/16 bits
Marker Output	14 bits: Three signals in waveform pattern, or real-time three-signal generation 15 bits: One signal in waveform pattern, or real-time three-signal generation 16 bits: Real-time three-signal generation Switching positive and negative logic pulse outputs
Internal Baseband Reference Clock	Range: 20 kHz to 160 MHz Resolution: 0.001 Hz
External Baseband Reference Clock	Range: 20 kHz to 40 MHz Division, multiplier function: Internally generate 1, 2, 4, 8, 16, 1/2, 1/4, 1/8 and 1/16 times input signals and use as DAC sampling clock Input connector: Aux connector (Rear panel) Input level ≥ 0.7 Vp-p, 50Ω (AC coupling)
Waveform Memory	Memory: 64 Msamples (without MS2830A-027) 256 Msamples (with MS2830A-027) File (Package) open count: Max. package count: 100 Max. patterns per package: 1000 However, 4096 patterns in total and 128 samples minimum per pattern SG Trigger input: Synchronize with trigger signals and start waveform pattern output. Switch start trigger/frame trigger Start trigger: To start waveform output Frame trigger: To output signals at burst timing To output data for burst length at frame trigger timing and wait for next frame trigger.
Input Connector	Function switch: Common start/frame trigger connector. Switch to use. Connector: BNC-J connector (Rear panel) Input level: TTL Logic: Select rise/fall polarity

AWGN Addition Function

CN Ratio Absolute Value	≤ 40 dB (with MS2830A-028)
-------------------------	---------------------------------

Signal Analyzer MS2830A Specifications

BER Measurement Function MS2830A-026

Connector	AUX connector(Rear panel)* *: Can convert to BNC by connecting AUX Conversion Adapter (J1556A).
Input Level	TTL Level
Input Signal	Data, Clock, Enable
Input Bit Rate	100 bps to 10 Mbps
Measured Patterns	PN9, PN11, PN15, PN20, PN23, ALLO, ALL1, Alternate (0101 ...) PN9Fix, PN11Fix, PN15Fix, PN20Fix, PN23Fix, User Define (4096 bits Max.)
Synchronization Establishing Condition	PN Signal: PN stage × 2 bit error free At PNFix Signal: PN stage × 2 bit error free, PN signal and sync establishment, establish sync with PNFix signal at PN stage error free from PNFix signal header bit ALLO, ALL1, Alternate (0101 ...): 10 bit error free UserDefine: 8 to 1024 bits (variable) error free Select header bit used at sync detection
Re-synchronization Judgment Condition	x/y (Resynchronization at detection of x-bit error in y bits) y ... Measured bit count: Select from 500 bits, 5000 bits, 50000 bits x ... Number of error bits in y bits: Setting range 1 to y/2
Measured Bit Count	$\leq 2^{32} - 1$ bits
Measured Error Bit Count	$\leq 2^{31} - 1$ bits
Measurement End Conditions	Measured bit count, Measured error bit count
Auto Re-synchronization Function	Can be toggled on and off
Operation at Resync.	Select from Count Clear, and Count Keep
Measurement Mode	Single, Endless, Continuous
Display	Status, Error, Error Rate, Error Count, SyncLoss Count, Measured bit count
Polarity Inversion Function	Supports polarity reversal for Data, Clock, Enable
Clear Measurement Function	At BER measurement, hold sync status, clears measured value and measures from 0

Low Phase Noise Performance MS2830A-066

Signal Analyzer/Spectrum Analyzer

Frequency Range	9 kHz to 3.7 GHz 9 kHz to 3.5 GHz (Frequency band mode: Spurious)
Span	300 Hz to 1 MHz (Spectrum Analyzer) 1 kHz to 31.25 MHz (Signal Analyzer)
SSB Phase Noise	18° to 28°C 500 MHz, Spectrum Analyzer, Switching speed mode: Normal mode -115 dBc/Hz (100 kHz offset) -133 dBc/Hz (1 MHz offset) with MS2830A-066, MS2830A-066: On Center frequency: 500 MHz, Span: ≤ 1 MHz (Spectrum Analyzer) -109 dBc/Hz (1 kHz offset) -118 dBc/Hz (10 kHz offset) -133 dBc/Hz (100 kHz offset) -148 dBc/Hz (1 MHz offset, nominal) Center frequency: 220 MHz, Span: ≤ 500 kHz (Spectrum Analyzer) -122 dBc/Hz (25 kHz offset)

Signal Analyzer MS2830A Specifications

MS2830A-066 Low Phase Noise Performance (Continued)

Spectrum Analyzer

<p>Displayed Average Noise Level (DANL)</p>	<p>18° to 28°C, Detector: Sample, VBW: 1 Hz (Video average), Input attenuator: 0 dB with MS2830A-066 installed and inactive, without MS2830A-008, or Preamp: Off</p> <ul style="list-style-type: none"> -120 dBm/Hz (9 kHz ≤ f < 100 kHz, nominal) -133 dBm/Hz (100 kHz) -133 dBm/Hz (100 kHz < f < 1 MHz, nominal) -143 dBm/Hz (1 MHz) -143 dBm/Hz (1 MHz < f < 10 MHz, nominal) -149 dBm/Hz (10 MHz ≤ f < 30 MHz, nominal) -152 dBm/Hz (30 MHz ≤ f < 1 GHz) -150 dBm/Hz (1 GHz ≤ f < 2.4 GHz) -147 dBm/Hz (2.4 GHz ≤ f ≤ 3.5 GHz) -144 dBm/Hz (3.5 GHz < f ≤ 6 GHz) [MS2830A-041/043] -142 dBm/Hz (6 GHz < f ≤ 13.5 GHz) [MS2830A-043] <p>with MS2830A-066 installed and active, without MS2830A-008, or Preamp: Off</p> <ul style="list-style-type: none"> -133 dBm/Hz (100 kHz) -143 dBm/Hz (1 MHz) -152 dBm/Hz (30 MHz ≤ f < 1 GHz) -150 dBm/Hz (1 GHz ≤ f < 2.4 GHz) -147 dBm/Hz (2.4 GHz ≤ f ≤ 3.5 GHz) -144 dBm/Hz (3.5 GHz < f ≤ 6 GHz) [MS2830A-041/043] -142 dBm/Hz (6 GHz < f ≤ 13.5 GHz) [MS2830A-043] <p>with MS2830A-066, with MS2830A-008, Preamp: On</p> <ul style="list-style-type: none"> -146 dBm/Hz (100 kHz, nominal) -155 dBm/Hz (1 MHz) -162 dBm/Hz (30 MHz ≤ f < 1 GHz) -161 dBm/Hz (1 GHz ≤ f < 2 GHz) -158 dBm/Hz (2 GHz ≤ f ≤ 3.5 GHz) -154 dBm/Hz (3.5 GHz < f ≤ 4 GHz, Frequency band mode: Normal) [MS2830A-041/043] -154 dBm/Hz (3.5 GHz < f ≤ 4 GHz, Frequency band mode: Spurious) [MS2830A-041/043] -154 dBm/Hz (4 GHz < f ≤ 6 GHz) [MS2830A-041/043]
<p>Image Responses</p>	<p>with MS2830A-066 MS2830A-066: On, Center frequency: ≤3.6 GHz, Span: ≤1 MHz (Spectrum Analyzer) Image responses (Input signal + 150 MHz): ≤-10 dBc (110 MHz ≤ f < 3.6 GHz)</p>
<p>Multiple Responses</p>	<p>with MS2830A-066 MS2830A-066: On, Center frequency: ≤3.6 GHz, Span: ≤1 MHz (Spectrum Analyzer), Mixer input level: -15 dBm ≤10 dBc (nominal)</p>

Signal Analyzer

<p>Displayed Average Noise Level (DANL)</p>	<p>18° to 28°C, Input attenuator: 0 dB with MS2830A-066, without MS2830A-008, or Preamp: Off</p> <ul style="list-style-type: none"> -130.5 dBm/Hz (100 kHz) -140.5 dBm/Hz (1 MHz) -149.5 dBm/Hz (30 MHz ≤ f < 1 GHz) -147.5 dBm/Hz (1 GHz ≤ f < 2.4 GHz) -144.5 dBm/Hz (2.4 GHz ≤ f ≤ 3.5 GHz) -141.5 dBm/Hz (3.5 GHz < f ≤ 6 GHz) [MS2830A-041/043] -139.5 dBm/Hz (6 GHz < f ≤ 13.5 GHz) [MS2830A-043] <p>with MS2830A-066, MS2830A-008, Preamp: On</p> <ul style="list-style-type: none"> -143.5 dBm/Hz (100 kHz, nominal) -152.5 dBm/Hz (1 MHz) -159.5 dBm/Hz (30 MHz ≤ f < 1 GHz) -158.5 dBm/Hz (1 GHz ≤ f < 2 GHz) -155.5 dBm/Hz (2 GHz ≤ f ≤ 3.5 GHz) -151.5 dBm/Hz (3.5 GHz < f ≤ 4 GHz, Frequency band mode: Normal) [MS2830A-041/043] -151.5 dBm/Hz (3.5 GHz < f ≤ 4 GHz, Frequency band mode: Spurious) [MS2830A-041/043] -151.5 dBm/Hz (4 GHz < f ≤ 6 GHz) [MS2830A-041/043]
---	---

Signal Analyzer MS2830A Specifications

Analysis Bandwidth Extension to 62.5 MHz MS2830A-077 (Requires MS2830A-005 and MS2830A-006)

Analysis Bandwidth Extension to 125 MHz MS2830A-078 (Requires MS2830A-005, MS2830A-006 and MS2830A-077)

An image response is received when setting the bandwidth to more than 31.25 MHz. This can be used when not inputting a signal frequency outside the MS2830A analysis bandwidth (125 MHz max.). The Signal Analyzer series MS2690A/91A/92A is recommended for other measurement purposes.

General

Analysis Bandwidth	Sets capture analysis bandwidth from center frequency 1 kHz to 25 MHz (1-2.5-5 sequence), 31.25 MHz, 50 MHz, 62.5 MHz (with MS2830A-077) 1 kHz to 25 MHz (1-2.5-5 sequence), 31.25 MHz, 50 MHz, 62.5 MHz, 100 MHz, 125 MHz (with MS2830A-078)
Sampling Rate	Auto setting by conditions of analysis bandwidth 2 kHz to 100 MHz (1-2-5 sequence) (with MS2830A-077) 2 kHz to 200 MHz (1-2-5 sequence) (with MS2830A-078)
Capture Time	with MS2830A-077, >31.25 MHz bandwidth Setting capture time length Minimum capture time length: 1 μ s Maximum capture time length: 500 ms Setting mode: Auto, Manual with MS2830A-078, >31.25 MHz bandwidth Setting capture time length Minimum capture time length: 500 ns to 1 μ s (Determined according to analysis bandwidth) Maximum capture time length: 500 ms Setting mode: Auto, Manual
ADC Resolution	with MS2830A-077/078, >31.25 MHz bandwidth 14 bits

Frequency

Frequency Setting	with MS2830A-077/078, >31.25 MHz bandwidth 300 MHz to 3.6 GHz [MS2830A-040] 300 MHz to 6 GHz [MS2830A-041] 300 MHz to 13.5 GHz [MS2830A-043]
Resolution Bandwidth (RBW)	with MS2830A-077, >31.25 MHz bandwidth Setting range: 1 Hz to 3 MHz (1-3 sequence) Selectivity (-60 dB/-3 dB): 4.5:1 (nominal) with MS2830A-078, >31.25 MHz bandwidth Setting range: 1 Hz to 10 MHz (1-3 sequence) Selectivity (-60 dB/-3 dB): 4.5:1 (nominal)

Signal Analyzer MS2830A Specifications

Analysis Bandwidth Extension to 62.5 MHz MS2830A-077 (Requires MS2830A-005 and MS2830A-006)

Analysis Bandwidth Extension to 125 MHz MS2830A-078 (Requires MS2830A-005, MS2830A-006 and MS2830A-077) (Continued)

Amplitude

Displayed Average Noise Level (DANL)	<p>18° to 28°C, Input attenuator: 0 dB With MS2830A-077, or 078, > 31.25 MHz bandwidth</p> <p>without MS2830A-066, MS2830A-008, or with MS2830A-008, Preamp: Off</p> <ul style="list-style-type: none"> -146.5 dBm/Hz (300 MHz ≤ f < 1 GHz) -144.5 dBm/Hz (1 GHz ≤ f < 2.4 GHz) -142.5 dBm/Hz (2.4 GHz ≤ f ≤ 3.5 GHz) -139.5 dBm/Hz (3.5 GHz < f ≤ 6 GHz) [MS2830A-041/043] -135.5 dBm/Hz (6 GHz < f ≤ 13.5 GHz) [MS2830A-043] <p>without MS2830A-066, with MS2830A-008, Preamp: On</p> <ul style="list-style-type: none"> -156.5 dBm/Hz (300 MHz ≤ f < 1 GHz) -155.5 dBm/Hz (1 GHz ≤ f < 2 GHz) -153.5 dBm/Hz (2 GHz ≤ f ≤ 3.5 GHz) -150.5 dBm/Hz (3.5 GHz < f ≤ 6 GHz) [MS2830A-041/043] <p>with MS2830A-066, without MS2830A-008, or Preamp: Off</p> <ul style="list-style-type: none"> -143.5 dBm/Hz (300 MHz ≤ f < 1 GHz) -141.5 dBm/Hz (1 GHz ≤ f < 2.4 GHz) -138.5 dBm/Hz (2.4 GHz ≤ f ≤ 3.5 GHz) -135.5 dBm/Hz (3.5 GHz < f ≤ 6 GHz) [MS2830A-041/043] -135.5 dBm/Hz (6 GHz < f ≤ 13.5 GHz) [MS2830A-043] <p>with MS2830A-066, MS2830A-008, Preamp: On</p> <ul style="list-style-type: none"> -153.5 dBm/Hz (300 MHz ≤ f < 1 GHz) -152.5 dBm/Hz (1 GHz ≤ f < 2 GHz) -149.5 dBm/Hz (2 GHz ≤ f ≤ 3.5 GHz) -145.5 dBm/Hz (3.5 GHz < f ≤ 6 GHz) [MS2830A-041/043]
Image Response	<p>with MS2830A-077/078, >31.25 MHz bandwidth</p> <p>Image Response (Occurs at frequency 200 MHz away): 0 dBc (nominal, 300 MHz < f ≤ 13.5 GHz)</p>
Linearity Error	<p>Excluding the noise floor effect</p> <p>without MS2830A-008, or Preamp: Off</p> <ul style="list-style-type: none"> ±0.07 dB (Mixer input level: ≤ -20 dBm) ±0.10 dB (Mixer input level: ≤ -10 dBm) <p>with MS2830A-008, Preamp: On</p> <ul style="list-style-type: none"> ±0.07 dB (Preamp input level: ≤ -40 dBm) ±0.10 dB (Preamp input level: ≤ -30 dBm)
RF Frequency Characteristics	<p>18° to 28°C, after CAL, Input attenuator: 10 dB, Frequency band mode: Normal</p> <p>without MS2830A-008, or Preamp: Off</p> <ul style="list-style-type: none"> ±0.35 dB (300 MHz ≤ f < 4 GHz) ±1.5 dB (4 GHz ≤ f ≤ 6 GHz) ±1.5 dB (6 GHz < f) <p>with MS2830A-008, Preamp: On</p> <ul style="list-style-type: none"> ±0.65 dB (300 MHz ≤ f < 4 GHz) ±1.8 dB (4 GHz ≤ f ≤ 6 GHz)

Internal Signal Generator Control Function MS2830A-052 (Requires any of MS2830A-020, 021, or 088)

This option measures the DUT transmission characteristics using linked operation between the Spectrum Analyzer functions and the installed signal generator. For the performance, refer to specifications for the Spectrum Analyzer function and the installed vector signal generator or analog signal generator.

Signal Analyzer MS2830A Specifications

3.6 GHz Analog Signal Generator MS2830A-088

Analog Function Extension for Vector Signal Generator MS2830A-029

The Analog Signal Generator and Analog Function Extension for Vector Signal Generator are used in combination with the Analog Measurement Software MX269018A.

And these are available to use for signal source of Internal Signal Generator Control Function MS2830A-052.

The following specifications are added to or changed from the specifications of the “Vector Signal Generator MS2830A-020/021” and “Low Power Extension for Vector Signal Generator MS2830A-022” installed.

Frequency

Frequency Setting Range	With FM, φM, AM modulation signal 100 kHz to 3000 MHz With Internal Signal Generator Control Function (MS2830A-052) 100 kHz to 3.6 GHz (With MS2830A-088 or MS2830A-020 + 029) 100 kHz to 6 GHz (With MS2830A-021 + 029)
Frequency Setting Resolution	1 Hz

Output Level

Output Setting Level	With FM, φM, AM modulation signal -127 to +15 dBm (Rx frequency: >25 MHz) -127 to -3 dBm (Rx frequency: ≤ 25 MHz) With Internal Signal Generator Control Function MS2830A-052 -127 to +15 dBm (> 25 MHz), -127 to -3 dBm (≤ 25 MHz) [MS2830A-088] -136 to +15 dBm (> 25 MHz), -136 to -3 dBm (≤ 25 MHz) [MS2830A-029]				
Output Level Accuracy	18° to 28°C, CW MS2830A-029/088 <table border="1" style="margin-left: 20px;"> <thead> <tr> <th></th> <th>Output level [p] (dBm)</th> </tr> </thead> <tbody> <tr> <td>±3.0 dB (typ., 100 kHz ≤ f < 250 kHz)</td> <td>-110 ≤ p ≤ -3</td> </tr> </tbody> </table> <p>Refer to the MS2830A-020/021 Vector Signal Generator section (with MS2830A-022) for the output level accuracy for other frequency ranges.</p>		Output level [p] (dBm)	±3.0 dB (typ., 100 kHz ≤ f < 250 kHz)	-110 ≤ p ≤ -3
	Output level [p] (dBm)				
±3.0 dB (typ., 100 kHz ≤ f < 250 kHz)	-110 ≤ p ≤ -3				

Arbitrary Signal Generator

Available when the MS2830A-020, 021 or 189 (Vector Signal Generator) is installed.
--

Typical (typ.): Performance not warranted. Must products meet typical performance.

Nominal: Values not warranted. Included to facilitate application of product.

Example: Performance not warranted. Data actually measured by randomly selected measuring instruments.

Options Configuration Guide

Options Configuration

Refer two table shown below about the hardware / software which each frequency model of MS2830A can implement.

Hardware

Frequency range (MS2830A-040/041/043/044/045) not upgradable.

✓ = Can be installed, No = Cannot be installed, R = Require, U = Upgrade

Opt.	Name	Retrofit	Addition to Main frame					Combination with "Option" (Refer to the left line)																												
			040	041	043	044	045	001	002	005	006	009	077	078	008	010	011	016	017	018	020	021	022	026	052	027	028	029	066	067	068	088	189	180		
001	Rubidium Reference Oscillator		✓	✓	✓	✓	✓	✗ ^{*9}																												
002	High Stability Reference Oscillator		✓	✓	✓	No	No	✗ ^{*9}	✗																											
005	Analysis Bandwidth Extension to 31.25 MHz		✓	✓	✓	✓	No																													
006	Analysis Bandwidth 10 MHz		✓	✓	✓	✓	✓																													
009	Bandwidth Extension to 31.25 MHz for Millimeter-wave		No	No	No	No	No	No	No	R	U	U								No	No	No	No			No	No	No	No		No	No				
077	Analysis Bandwidth Extension to 62.5 MHz	No	✓	✓	✓	✓	✓																													
078	Analysis Bandwidth Extension to 125 MHz	No	✓	✓	✓	✓	✓																													
008	Preamplifier		✓	✓	✓	*1	*1																												*1	
010	Phase Noise Measurement Function		✓	✓	✓	✓	✓																													
011	2ndary HDD		✓	✓	✓	✓	✓																													
016	Precompliance EMI Function		✓	✓	✓	✓	✓																													
017	Noise Figure Measurement Function		✓	✓	✓	✓	✓								U																				U	
018	Audio Analyzer*4		✓	✓	*7	No	No																												R	
020	3.6 GHz Vector Signal Generator		✓	✓	*2	No	No																												No	
021	6 GHz Vector Signal Generator		✓	✓	*2	No	No																												No	
022	Low Power Extension for Vector Signal Generator		✓	✓	No	No	No																												No	
026	BER Measurement Function		✓	✓	✓	✓	✓																													
052	Internal Signal Generator Control Function	*12	✓	✓	*2	No	No																												*11	
027	ARB Memory Upgrade 256 Ms for Vector Signal Generator		✓	✓	✓	No	No																												No	
028	AWGN		✓	✓	✓	No	No																												No	
029	Analog Function Extension for Vector Signal Generator*4	*8	✓	✓	No	No	No																												No	
066	Low Phase Noise Performance	No	✓	✓	*2	No	No																												No	
067	Microwave Preselector Bypass		No	No	No	✓	✓	No																											No	
068	Microwave Preamplifier		No	No	No	*1	*1	No																											No	
088	3.6 GHz Analog Signal Generator*4		✓	✓	No	No	No																												No	
189	Vector Function Extension for Analog Signal Generator Retrofit		✓	✓	No	No	No																												No	
180	CPU/Windows 7 64 bit Upgrade Retrofit	*10	✓	✓	✓	✓	✓																													✗

- *1: Cannot be installed simultaneously MS2830A-008 and MS2830A-068/168. When MS2830A-168 is added to Signal Analyzer with MS2830A-008, only MS2830A-168 becomes effective.
- *2: MS2830A-043 can implement only either MS2830A-020/021 or MS2830A-066.
- *3: MS2830A-027 and MS2830A-028 are not used in analog signal generator (MS2830A-088/188).
After vector function (MS2830A-189) was added, the vector signal generator function can add MS2830A-027 and MS2830A-028.
- *4: Require MX269018A.
- *5: MS2830A-040/041/043/044 require MS2830A-005.
MS2830A-045 requires MS2830A-009.
- *6: An image response is received when setting the bandwidth to more than 31.25 MHz.
This can be used when not inputting a signal frequency outside the MS2830A analysis bandwidth (125 MHz max.).
The Signal Analyzer series MS2690A/91A/92A is recommended for other measurement purposes.
- *7: The MS2830A-018 can be installed with MS2830A-043 but cannot be installed simultaneously with a signal generator (MS2830A-088/020/021/029) because MS2830A-066 is required. Consequently, analog wireless Rx tests cannot be performed using the same main frame when the MS2830A-018 and MS2830A-043 are combined.
- *8: Please contact our sales representative when requesting retrofitting.
- *9: The Rubidium Reference Oscillator can be retrofitted to MS2830A-040/041/043 with installed High Stability Reference Oscillator.
In this case, the Rubidium Reference Oscillator is functional.
- *10: Replace current CPU board of MS2830A which Windows Embedded Standard 2009 (Windows XP) is installed (it was ordered until August 2016 approximately) and upgrade the operating system to Windows Embedded Standard 7 (Windows 7).
A seal labeled "C1" is affixed near the serial number label of MS2830A which is installed Windows 7.
- *11: Installing the MS2830A-052 requires any of the MS2830A-020/120, 021/121, or 088/188 options.
- *12: When retrofitting signal generator-linked functions (MS2830A-352), the license is delivered on an accessory DVD which is used to install the license in the MS2830A. It is not necessary to return the MS2830A to Anritsu for upgrading.

Options Configuration Guide

Software

✓ = Can be installed, No = Cannot be installed, R = Require, U = Upgrade

Model	Name	Addition to Main frame					Analysis Bandwidth					Note		
		040	041	043	044	045	005	006	009	077	078			
MX269011A	W-CDMA/HSPA Downlink Measurement Software	✓	✓	✓	✓	✓								
MX269012A	W-CDMA/HSPA Uplink Measurement Software	✓	✓	✓	✓	✓		R						
MX269013A	GSM/EDGE Measurement Software	✓	✓	✓	✓	✓		R						
MX269013A-001	EDGE Evolution Measurement Software	✓	✓	✓	✓	✓		R						Require MX269013A
MX269015A	TD-SCDMA Measurement Software	✓	✓	✓	✓	✓		R						
MX269017A	Vector Modulation Analysis Software	✓	✓	✓	*3	*3	U	R	*1	U	U			U: Upgrade of the phase noise performance (MS2830A-066) (Measured signal: Frequency <3.6 GHz, Bandwidth <1 MHz)
MX269018A	Analog Measurement Software	✓	✓	*2	No	No			No					Require MS2830A-066 and A0086C (See MX2690xxA series Measurement Software catalog for detail) Note) MS2830A-043 cannot implement a signal generator for Rx test (Because MS2830A-066 is required)
MX269020A	LTE Downlink Measurement Software	✓	✓	✓	✓	✓	R	R	*1					
MX269020A-001	LTE-Advanced FDD Downlink Measurement Software	✓	✓	✓	✓	✓	R	R	*1	U	U			Require MX269020A
MX269021A	LTE Uplink Measurement Software	✓	✓	✓	✓	✓	R	R	*1					
MX269021A-001	LTE-Advanced FDD Uplink Measurement Software	✓	✓	✓	✓	✓	R	R	*1	U	U			Require MX269021A
MX269022A	LTE TDD Downlink Measurement Software	✓	✓	✓	✓	✓	R	R	*1					
MX269022A-001	LTE-Advanced TDD Downlink Measurement Software	✓	✓	✓	✓	✓	R	R	*1	U	U			Require MX269022A
MX269023A	LTE TDD Uplink Measurement Software	✓	✓	✓	✓	✓	R	R	*1					
MX269023A-001	LTE-Advanced TDD Uplink Measurement Software	✓	✓	✓	✓	✓	R	R	*1	U	U			Require MX269023A
MX269024A	CDMA2000 Forward Link Measurement Software	✓	✓	✓	✓	✓		R						
MX269024A-001	All Measure Function	✓	✓	✓	✓	✓		R						Require MX269024A
MX269026A	EV-DO Forward Link Measurement Software	✓	✓	✓	✓	✓		R						
MX269026A-001	All Measure Function	✓	✓	✓	✓	✓		R						Require MX269026A
MX269028A	WLAN (802.11) Measurement Software	✓	✓	✓	✓	✓	R	R	*1					
MX269028A-001	802.11ac (80 MHz) Measurement Software	✓	✓	✓	✓	✓	R	R	*1	R	R			Only for MS2830A. Require MX269028A
MX269030A	W-CDMA BS Measurement Software	✓	✓	✓	✓	✓		R						
MX283027A	Wireless Network Device Test Software	↓	↓	↓	↓	↓	↓	↓	↓					
MX283027A-001	WLAN Test Software	✓	✓	✓	✓	✓	R	R	*1					Require MX283027A*4
MX283027A-002	Bluetooth Test Software	✓	✓	✓	✓	✓	R	R						Require MX283027A
MX283087A	TRX Sweep Calibration	✓	✓	✓	No	No	R	R						Require MS2830A-020/021 and MS2830A-022

*1: MS2830A-045 cannot be installed MS2830A-005. Add MS2830A-009 in substitution for MS2830A-005.

*2: MS2830A-043 can implement only either MS2830A-020/021 or MS2830A-066.

By the system that MS2830A-066 is necessary, MS2830A-020/021 is not added to MS2830A-043.

*3: By the measurement of the narrowband signal, add MS2830A-066. (Channel bandwidth: x kHz to 100 kHz)

MS2830A-044/045 cannot be installed MS2830A-066.

*4: MX283027A-001 includes MX269911A WLAN IQproducer (Cannot order MX283027A-001 and MX269911A at same time).

Signal Analyzer MS2830A Ordering Information

Please specify the model/order number, name and quantity when ordering.
The names listed in the chart below are Order Names. The actual name of the item may differ from the Order Name.

Model/Order No.	Name
MS2830A	- Main frame - Signal Analyzer
P0031A Z0541A	- Standard accessories - Power Cord: 1 pc USB Memory (≥256 MB, USB2.0 Flash Driver): 1 pc USB Mouse: 1 pc Install CD-ROM (Application software, instruction manual CD-ROM): 1 pc
MS2830A-040 MS2830A-041 MS2830A-043	- Options - 3.6 GHz Signal Analyzer 6 GHz Signal Analyzer 13.5 GHz Signal Analyzer
MS2830A-001 MS2830A-002 MS2830A-005*1	Rubidium Reference Oscillator High Stability Reference Oscillator Analysis Bandwidth Extension to 31.25 MHz (Requires MS2830A-006)
MS2830A-006 MS2830A-008 MS2830A-010 MS2830A-011 MS2830A-016 MS2830A-017 MS2830A-018 MS2830A-026*2	Analysis Bandwidth 10 MHz Preamplifier Phase Noise Measurement Function 2ndary HDD Precompliance EMI Function Noise Figure Measurement Function Audio Analyzer BER Measurement Function (J1556A AUX Conversion Adapter as standard accessory)
MS2830A-066*3 MS2830A-077*4 MS2830A-078*5 MS2830A-311	Low Phase Noise Performance Analysis Bandwidth Extension to 62.5 MHz Analysis Bandwidth Extension to 125 MHz 2ndary HDD Retrofit
MS2830A-020 MS2830A-021 MS2830A-022 MS2830A-027 MS2830A-028 MS2830A-029*6 MS2830A-052*7 MS2830A-088	3.6 GHz Vector Signal Generator 6 GHz Vector Signal Generator Low Power Extension for Vector Signal Generator ARB Memory Upgrade 256 Msa for Vector Signal Generator AWGN Analog Function Extension for Vector Signal Generator Internal Signal Generator Control Function 3.6 GHz Analog Signal Generator
MS2830A-101 MS2830A-102 MS2830A-105*1 MS2830A-106 MS2830A-108 MS2830A-110 MS2830A-111 MS2830A-116 MS2830A-117 MS2830A-118 MS2830A-126*2 MS2830A-352*7 MS2830A-120 MS2830A-121 MS2830A-122 MS2830A-127 MS2830A-128 MS2830A-188 MS2830A-189 MS2830A-152*7 MS2830A-180*8	- Retrofit options - Rubidium Reference Oscillator Retrofit High Stability Reference Oscillator Retrofit Analysis Bandwidth Extension to 31.25 MHz Retrofit (Requires MS2830A-006) Analysis Bandwidth 10 MHz Retrofit Preamplifier Retrofit Phase Noise Measurement Function Retrofit 2ndary HDD Retrofit Precompliance EMI Function Retrofit Noise Figure Measurement Function Retrofit Audio Analyzer Retrofit BER Measurement Function Retrofit (J1556A AUX Conversion Adapter as standard accessory) Internal Signal Generator Control Function User-Installable 3.6 GHz Vector Signal Generator Retrofit 6 GHz Vector Signal Generator Retrofit Low Power Extension for Vector Signal Generator Retrofit ARB Memory Upgrade 256 Msa for Vector Signal Generator Retrofit AWGN Retrofit 3.6 GHz Analog Signal Generator Retrofit Vector Function Extension for Analog Signal Generator Retrofit Internal Signal Generator Control Function Retrofit CPU/Windows 7 64 bit Upgrade Retrofit

- *1: Requires MS2830A-006/106.
- *2: The J1556A AUX Conversion Adapter is a standard accessory supplied with MS2830A-026/126.
- *3: Retrofit not supported.
- *4: MS2830A-066 sometimes cannot be installed depending on options.

Model	Case 1	Case 2	Case 3
MS2830A-020/021	Yes	Yes	No
MS2830A-043	Yes	No	Yes
MS2830A-066	No	Yes	Yes

Model/Order No.	Name
	- Software options - CD-ROM with License and Operation manuals
MX269011A MX269012A MX269013A MX269013A-001	W-CDMA/HSPA Downlink Measurement Software W-CDMA/HSPA Uplink Measurement Software GSM/EDGE Measurement Software EDGE Evolution Measurement Software (Requires MX269013A)
MX269015A MX269017A MX269018A	TD-SCDMA Measurement Software Vector Modulation Analysis Software Analog Measurement Software (For MS2830A. Requires MS2830A-066 and A0086C)
MX269020A MX269020A-001	LTE Downlink Measurement Software LTE-Advanced FDD Downlink Measurement Software (Requires MX269020A)
MX269021A MX269021A-001	LTE Uplink Measurement Software LTE-Advanced FDD Uplink Measurement Software (Requires MX269021A)
MX269022A MX269022A-001	LTE TDD Downlink Measurement Software LTE-Advanced TDD Downlink Measurement Software (Requires MX269022A)
MX269023A MX269023A-001	LTE TDD Uplink Measurement Software LTE-Advanced TDD Uplink Measurement Software (Requires MX269023A)
MX269024A MX269024A-001 MX269026A MX269026A-001 MX269028A MX269028A-001	CDMA2000 Forward Link Measurement Software All Measure Function (Requires MX269024A) EV-DO Forward Link Measurement Software All Measure Function (Requires MX269026A) WLAN (802.11) Measurement Software 802.11ac (80 MHz) Measurement Software (For MS2830A. Requires MX269028A.)
MX269030A MX283027A MX283027A-001 MX283027A-002 MX283087A	W-CDMA BS Measurement Software Wireless Network Device Test Software WLAN Test Software (Requires MX283027A) Bluetooth Test Software (Requires MX283027A) TRX Sweep Calibration
MX269901A MX269902A MX269904A MX269905A MX269908A MX269908A-001 MX269910A MX269910A-001 MX269911A MX269911A-001 MX269912A MX269970A	HSDPA/HSUPA IQproducer TDMA IQproducer Multi-Carrier IQproducer Mobile WiMAX IQproducer LTE IQproducer LTE-Advanced FDD Option (Requires MX269908A) LTE TDD IQproducer LTE-Advanced TDD Option (Requires MX269910A) WLAN IQproducer 802.11ac (80 MHz) Option (Requires MX269911A) TD-SCDMA IQproducer 1xEV-DO Reverse Receiver Test Waveform Pattern
MX705010A MX705110A	- Other Software Options - These software are for PC. Wi-SUN PHY Measurement Software Wi-SUN Protocol Monitor
MS2830A-ES210 MS2830A-ES310 MS2830A-ES510	- Warranty service - 2 years Extended Warranty Service 3 years Extended Warranty Service 5 years Extended Warranty Service

- *4: Retrofit not supported. Requires MS2830A-005 and MS2830A-006.
- *5: Retrofit not supported. Requires MS2830A-005, MS2830A-006 and MS2830A-077.
- *6: Please contact our sales representative when requesting retrofitting.
- *7: Requires any of MS2830A-020/120, 021/121, or 088/188.
For details, refer to the Options Configuration Guide: Hardware item.
- *8: Replace the CPU board and upgrade the OS to Windows 7.
For details, refer to the Options Configuration Guide: Hardware item.

Signal Analyzer MS2830A Ordering Information

Model/Order No	Name	Model/Order No	Name
	- Application parts -		
W3334AE W2851AE	Following operation manuals provided as hard copy MS2830A Operation Manual (Mainframe Operation) MS2690A/MS2691A/MS2692A and MS2830A/MS2840A/MS2850A Operation Manual (Mainframe Remote Control)	W2915AE W2916AE W2917AE W2918AE W3023AE W3221AE W3488AE W3582AE W3675AE	MX269901A Operation Manual MX269902A Operation Manual MX269904A Operation Manual MX269905A Operation Manual MX269908A Operation Manual MX269910A Operation Manual MX269911A Operation Manual MX269912A Operation Manual MX269970A Operation Manual
W3335AE	MS2830A/MS2840A/MS2850A Operation Manual (Signal Analyzer Function Operation)	K240B	Power Divider (K connector, DC to 26.5 GHz, 50Ω, K-J, 1 W max.)
W2853AE	MS2690A/MS2691A/MS2692A and MS2830A/MS2840A/MS2850A Operation Manual (Signal Analyzer Function Remote Control)	MA1612A	Four-port Junction Pad (5 MHz to 3 GHz, N-J)
W3336AE	MS2830A/MS2840A/MS2850A Operation Manual (Spectrum Analyzer Function Operation)	J0576B	Coaxial Cord, 1 m (N-P · 5D-2W · N-P)
W2855AE	MS2690A/MS2691A/MS2692A and MS2830A/MS2840A/MS2850A Operation Manual (Spectrum Analyzer Function Remote Control)	J0576D	Coaxial Cord, 2 m (N-P · 5D-2W · N-P)
W3117AE	MS2690A/MS2691A/MS2692A and MS2830A/MS2840A/MS2850A Operation Manual (Phase Noise Measurement Function Operation)	J0127A	Coaxial Cord, 1 m (BNC-P · RG58A/U · BNC-P)
W3118AE	MS2690A/MS2691A/MS2692A and MS2830A/MS2840A/MS2850A Operation Manual (Phase Noise Measurement Function Remote Control)	J0127B	Coaxial Cord, 2 m (BNC-P · RG58A/U · BNC-P)
W3655AE	MS2690A/MS2691A/MS2692A and MS2830A/MS2840A/MS2850A-017 Operation Manual (Noise Figure Measurement Function Operation)	J0127C	Coaxial Cord, 0.5 m (BNC-P · RG58A/U · BNC-P)
W3656AE	MS2690A/MS2691A/MS2692A and MS2830A/MS2840A/MS2850A-017 Operation Manual (Noise Figure Measurement Function Remote control)	J0322A	Coaxial Cord, 0.5 m (DC to 18 GHz), (SMA-P · 50Ω SUCOFLEX104 · SMA-P)
W3337AE	MS2830A/MS2840A-020/021 Operation Manual (Vector Signal Generator Option Operation)	J0322B	Coaxial Cord, 1 m (DC to 18 GHz), (SMA-P · 50Ω SUCOFLEX104 · SMA-P)
W3338AE	MS2830A/MS2840A-020/021 Operation Manual (Vector Signal Generator Option Remote Control)	J0322C	Coaxial Cord, 1.5 m (DC to 18 GHz), (SMA-P · 50Ω SUCOFLEX104 · SMA-P)
W2914AE	MS2690A/MS2691A/MS2692A and MS2830A/MS2840A Operation Manual (I/Qproducer for Vector Signal Generator Option)	J0322D	Coaxial Cord, 2 m (DC to 18 GHz), (SMA-P · 50Ω SUCOFLEX104 · SMA-P)
W2929AE	MS2690A/MS2691A/MS2692A and MS2830A/MS2840A Operation Manual (Standard Waveform Pattern for Vector Signal Generator Option)	J0805	DC Block, N type (MODEL 7003) (10 kHz to 18 GHz, N-P · N-J)
W2919AE	MX269010A Operation Manual (Operation)	J1554A	DC Block, SMA type (MODEL 7006) (9 kHz to 26.5 GHz, SMA-P · SMA-J)
W2954AE	MX269010A Operation Manual (Remote Control)	J1555A	DC Block, SMA type (MODEL 7006-1) (9 kHz to 20 GHz, SMA-P · SMA-J)
W3098AE	MX269011A Operation Manual (Operation)	K261	DC Block (10 kHz to 40 GHz, K-P · K-J)
W3099AE	MX269011A Operation Manual (Remote Control)	J0004	Coaxial Adapter (DC to 12.4 GHz, 50Ω, N-P · SMA-J)
W3060AE	MX269012A Operation Manual (Operation)	J1398A	N-SMA Adapter (DC to 26.5 GHz, 50Ω, N-P · SMA-J)
W3061AE	MX269012A Operation Manual (Remote Control)	34AKNF50	Ruggedized K-to-Type N Adapter (DC to 20 GHz, 50Ω, Ruggedized K-M · N-F, SWR: 1.5 (max.), Insertion Loss: 0.4 dB (max.))
W3100AE	MX269013A Operation Manual (Operation)	J0911	Coaxial Cable, 1.0 m for 40 GHz (DC to 40 GHz, approx. 1 m, SF102A, 11K254/K254/1.0M)
W3101AE	MX269013A Operation Manual (Remote Control)	J0912	Coaxial Cable, 0.5 m for 40 GHz (DC to 40 GHz, approx. 0.5 m, SF102A, 11K254/K254/0.5M)
W3044AE	MX269015A Operation Manual (Operation)	41KC-3	Fixed Attenuator (DC to 40 GHz, 3 dB)
W3045AE	MX269015A Operation Manual (Remote Control)	J1261A	Ethernet Cable (Shield type, Straight, 1 m)
W3305AE	MX269017A Operation Manual (Operation)	J1261B	Ethernet Cable (Shield type, Straight, 3 m)
W3306AE	MX269017A Operation Manual (Remote Control)	J1261C	Ethernet Cable (Shield type, Cross, 1 m)
W3555AE	MX269018A Operation Manual (Operation)	J1261D	Ethernet Cable (Shield type, Cross, 3 m)
W3556AE	MX269018A Operation Manual (Remote Control)	J0008	GPIB Cable, 2.0 m
W3014AE	MX269020A Operation Manual (Operation)	J1556A*9	AUX Conversion Adapter (AUX → BNC, for vector signal generator option and BER measurement function option)
W3064AE	MX269020A Operation Manual (Remote Control)	A0086C	USB Audio (for MX269018A)
W3015AE	MX269021A Operation Manual (Operation)	B0635A	Rack Mount Kit (EIA)
W3065AE	MX269021A Operation Manual (Remote Control)	B0657A	Rack Mount Kit (JIS)
W3209AE	MX269022A Operation Manual (Operation)	B0636C*10	Carrying Case (Hard type, with casters)
W3210AE	MX269022A Operation Manual (Remote Control)	B0671A*10	Front Cover for 1MW4U
W3521AE	MX269023A Operation Manual (Operation)	MA24105A	Inline Peak Power Sensor (350 MHz to 4 GHz, with USB A to mini B cable)
W3522AE	MX269023A Operation Manual (Remote Control)	MA24106A	USB Power Sensor (50 MHz to 6 GHz, with USB A to mini B cable)
W3201AE	MX269024A Operation Manual (Operation)	MA24108A	Microwave USB Power Sensor (10 MHz to 8 GHz, with USB A to Micro-B cable)
W3202AE	MX269024A Operation Manual (Remote Control)	MA24118A	Microwave USB Power Sensor (10 MHz to 18 GHz, with USB A to Micro-B cable)
W3203AE	MX269026A Operation Manual (Operation)	MA24126A	Microwave USB Power Sensor (10 MHz to 26 GHz, with USB A to Micro-B cable)
W3204AE	MX269026A Operation Manual (Remote Control)	Z0975A	Keyboard (USB)
W3528AE	MX269028A Operation Manual (Operation)	Z1345A	Installation Kit (required when retrofitting options or installing software)
W3529AE	MX269028A Operation Manual (Remote Control)		
W2860AE	MX269030A Operation Manual (Operation)		
W2861AE	MX269030A Operation Manual (Remote Control)		
W3471AE	MX283027A Operation Manual (Operation)		
W3473AE	MX283027A-001 Operation Manual (Operation)		
W3474AE	MX283027A-001 Operation Manual (Remote Control)		
W3516AE	MX283027A-002 Operation Manual (Operation)		
W3517AE	MX283027A-002 Operation Manual (Remote Control)		
W3448AE	MX283087A Operation Manual (Operation)		
W3449AE	MX283087A Operation Manual (Remote Control)		

*9: The AUX Conversion Adapter J1556A is not a standard accessory for the Vector Signal Generator Option MS2830A-020/120/021/121.

The AUX Conversion Adapter J1556A is a standard accessory supplied with BER Measurement Function MS2830A-026/126.

*10: The Carrying Case B0636C includes a Front Panel Protective Cover (B0671A).

Signal Analyzer MS2830A Ordering Information



AUX Conversion Adapter J1556A



USB Power Sensor MA24106A



Carrying Case B0636C
(Hard type, with casters)



MS2830A with Front Cover
Front Cover for 1MW4U B0671A