



Wireless Connectivity Test Set MT8862A



Contents

- Market Trend & Solutions
- MT8862A Product Introduction
- MT8862A Applications





Market Trend & Solutions

Rise of Non-cellular IoT Devices and Diversifying Wireless Standards

Increase in non-cellular IoT devices

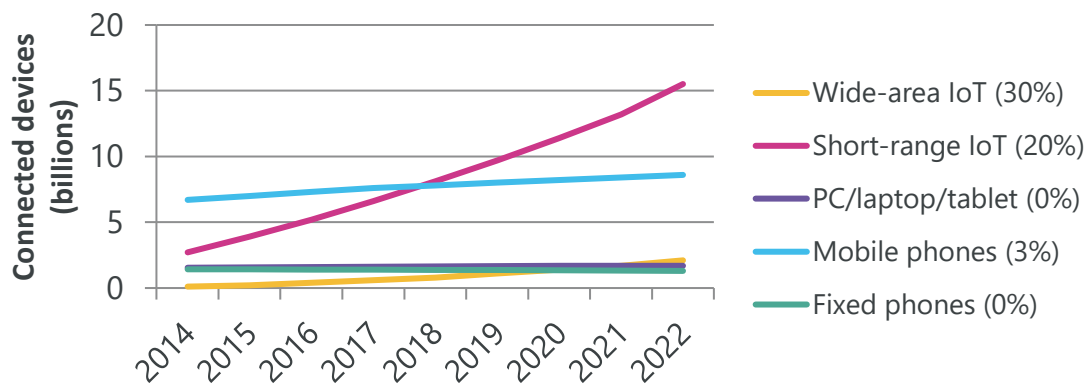

The number of Short-range IoT devices is expected to increase in future and will exceed the number of mobile phones. It is assumed that IoT devices will be used for IoT that will expand in the future.

Source: ERICSSON MOBILITY REPORT JUNE 2017

OTA testing and IEEE 802.11ax spread rapidly

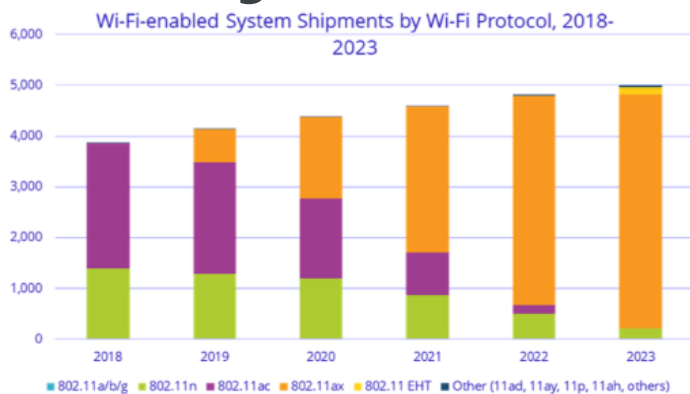

Source : Wi-Fi chipset shipment forecast by IDC towards 2023

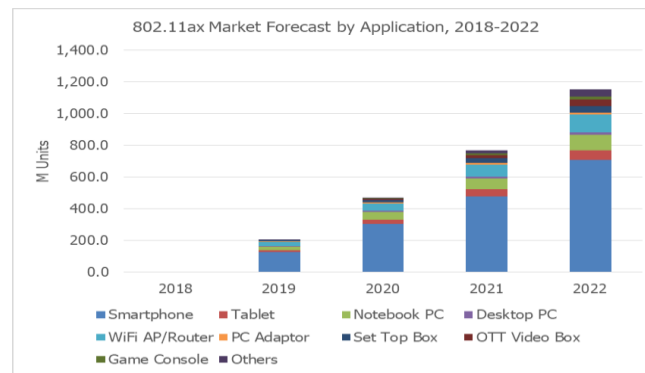

Source : 2018 Wireless Connectivity Market Analysis

11ax (Wi-Fi 6) is growing rapidly from 2019, it will be the main standard on WLAN specification behalf on 11ac. Also The demand of OTA test is expected to be increasing for the quality assurance with a focus on Smartphone market.

Market Trend

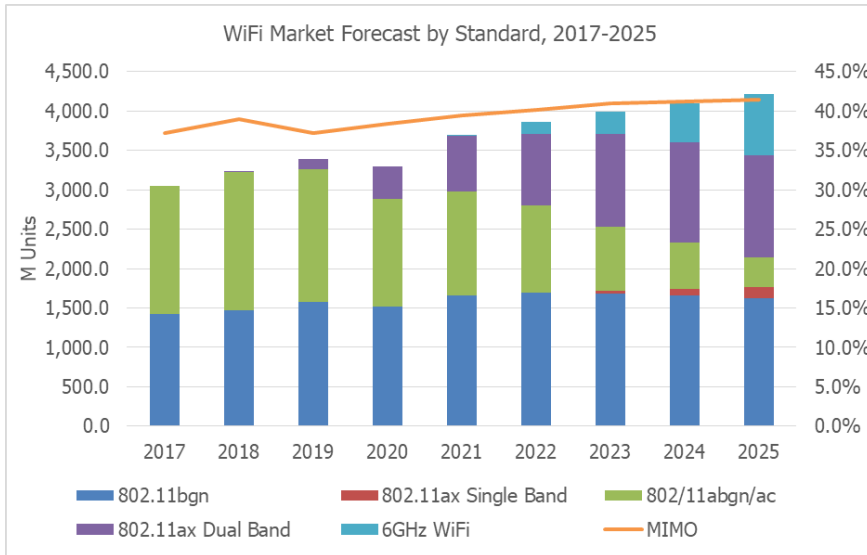

Source : Techno System Research
2020 Wireless Connectivity Market Analysis

Forecast for Smartphone 6 GHz Band

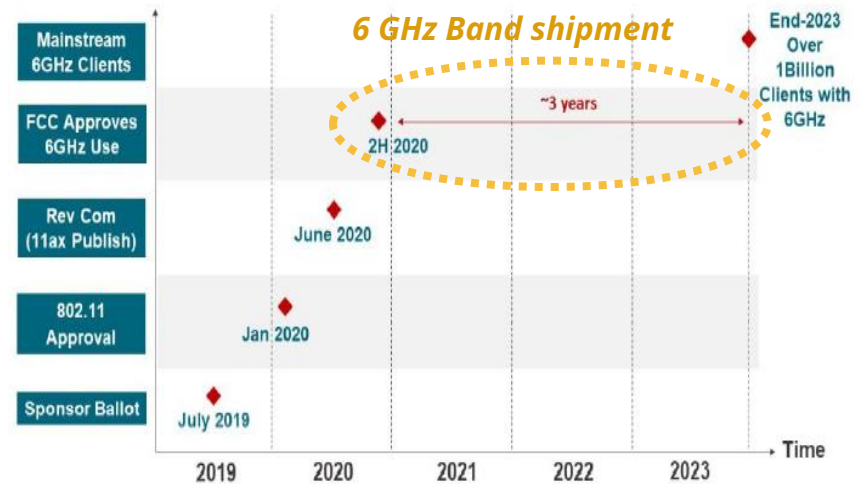

Source : Onsemi's web site
<https://www.onsemi.com/blog/iot/adaptive-mimo-in-the-era-of-6ghzwi-fi>

■ 6 GHz Band (802.11ax and 802.11be)

- IEEE802.11ax specification to be released as major standard officially in 2021.
- FCC approved 6 GHz band for unlicensed use on April 23 2020, targeting 11ax/be.
- Also reported that ETSI approval for sub-6 GHz band to be completed in December 2021.
- Leading-edge chipset suppliers started releasing Wi-Fi 6E chipsets in second quarter 2020 to match market start. Trigger should be official FCC or ETSI release.
- Number of 6 GHz devices assumed to exceed 1 billion by late 2023.

■ 6 GHz Band Test & Measurement

- Since this will be the first new WLAN band in about 20 years, it must support the new technology and evaluate the performance of the RF frontend and antennas.
- Some integration from OTA chamber suppliers is required to meet market requirements.

Unlicensed 6 GHz Band Adoption

The 6 GHz band spectrum is 1200 MHz wide from 5925 to 7125 MHz.

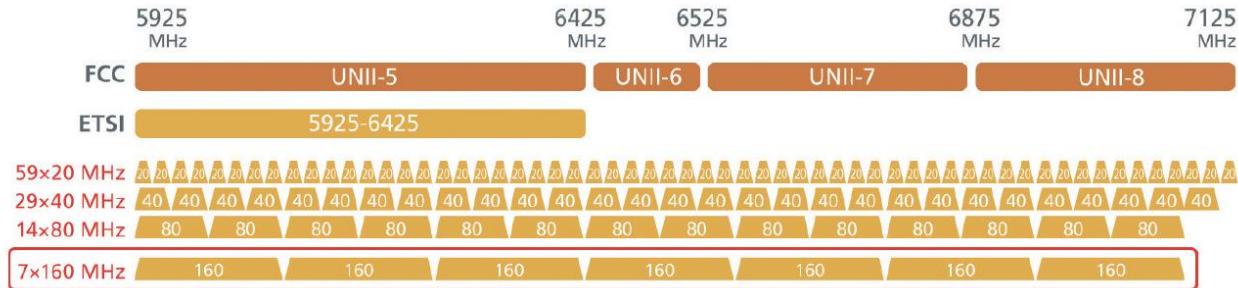

Each country is opening the 6 GHz band spectrum to unlicensed WLAN use.

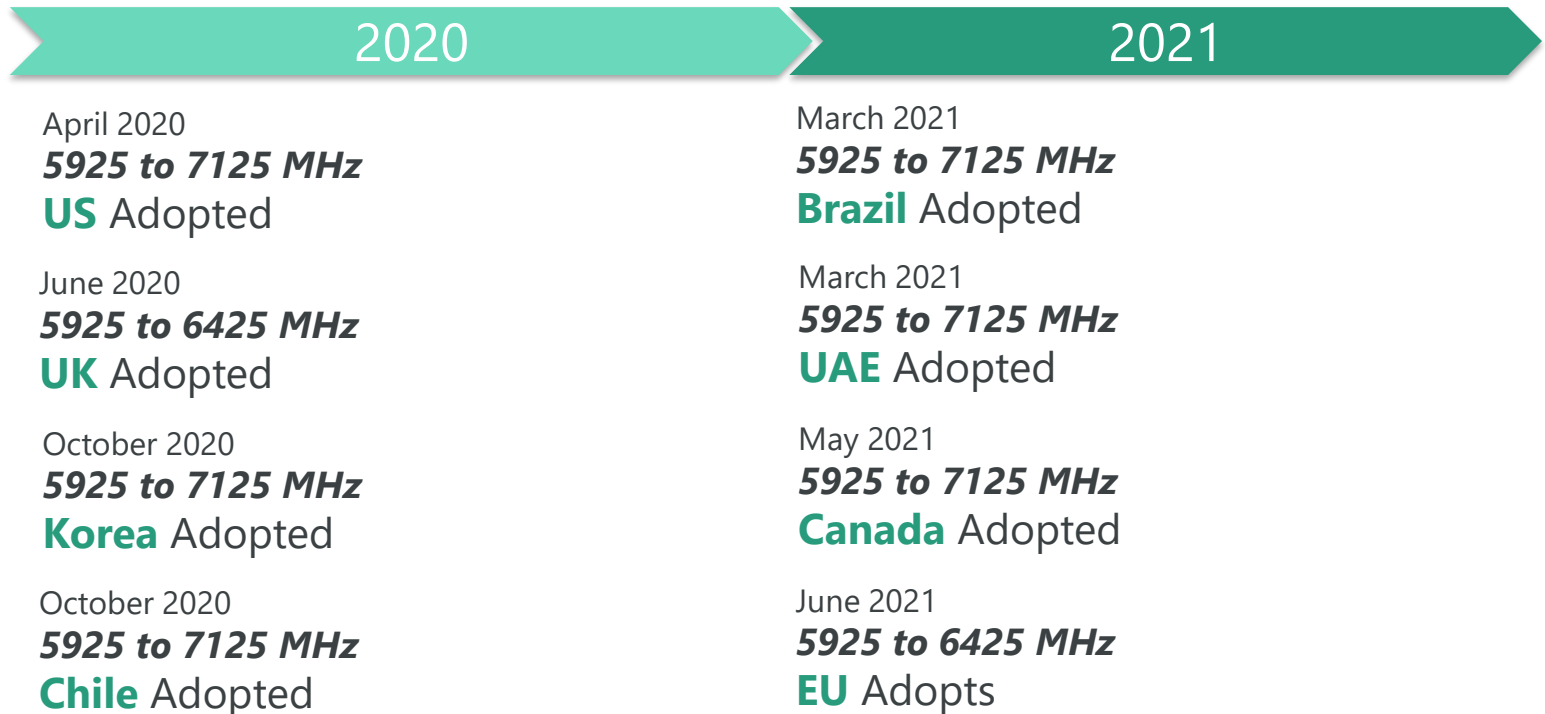

Expanding WLAN Applications & Increasing Device Complexity

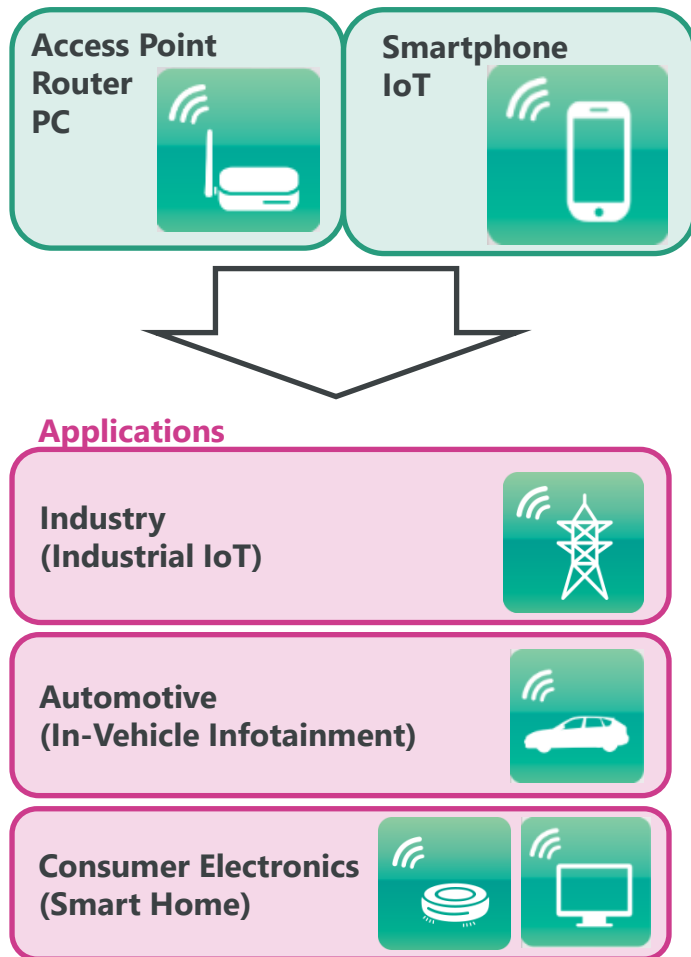

Expanding WLAN applications

WLAN applications are expanding, and usage environments and quality requirements are changing. On this background OTA test with network mode is paid a lot of attention

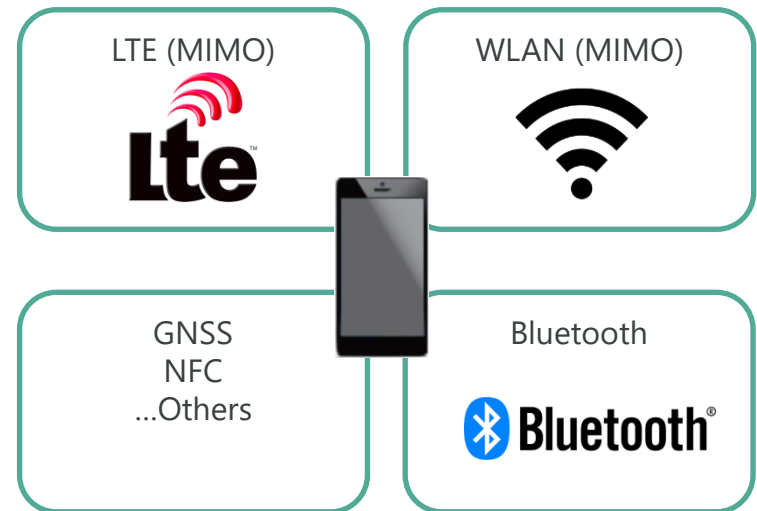

Increasing device complexity

Devices are using more wireless technologies and antennas year-by-year, increasing device complexity. Therefore, shipping products need evaluation more than ever.

Solutions from Development to Production

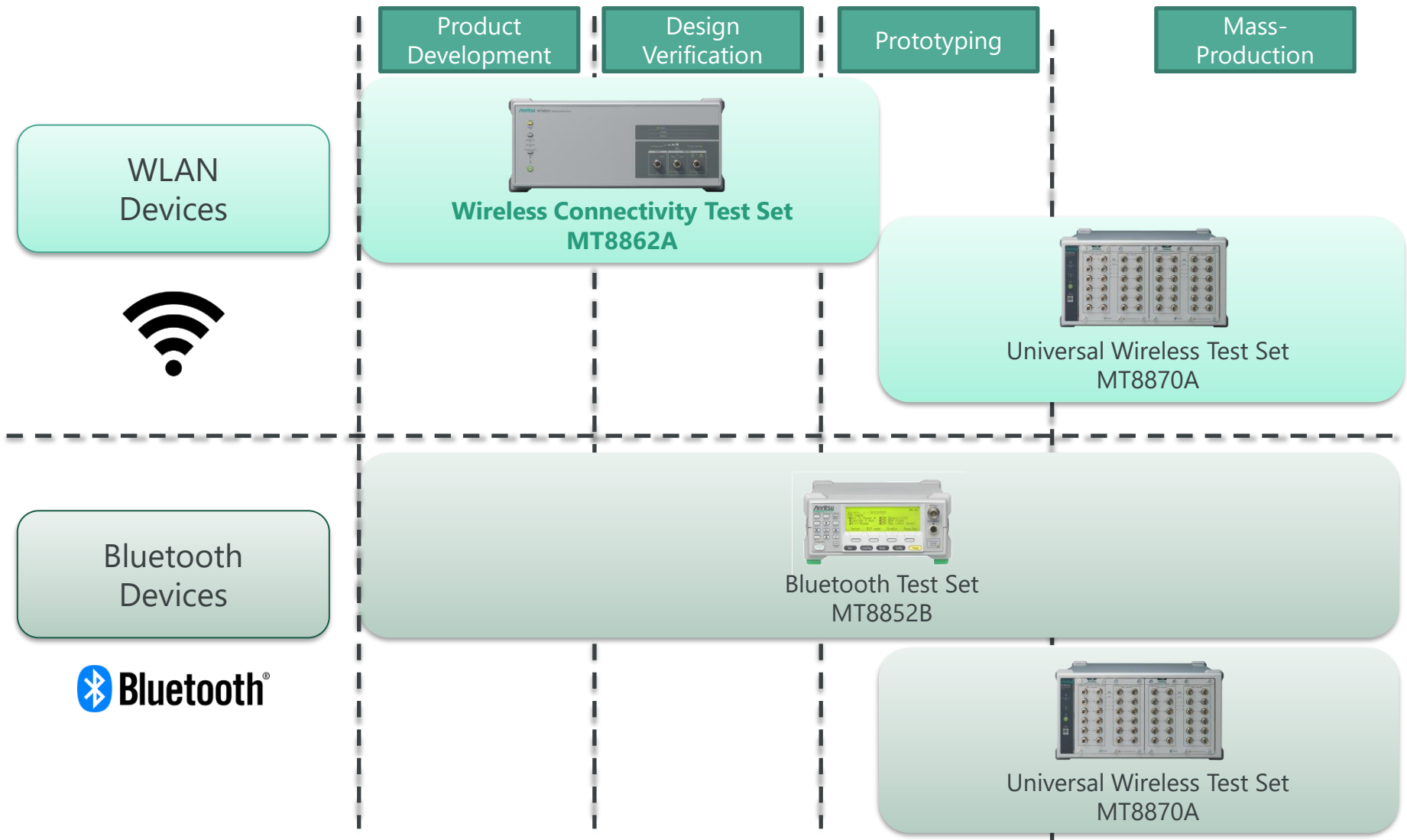

Anritsu has solutions for every stage.

Changing mode Tailored to Use

Choices matching measurement use because MT8862A has two measurement mode.



Wireless Connectivity Test Set MT8862A

	Network Mode	Direct Mode
Advantage	Easy test environment with no DUT control because measured using standard connection	Fast measurement because DUT controlled directly from external PC and optimized for mass production
Disadvantage	Time to establish connection	Requires DUT control
Use	Product development Design validation End-product verification	Prototyping Product development



MT8862A Product Introduction

MT8862A Product Summary

MT8862A is the powerful tool for RF performance tests of commercial products by simple setup with Network Mode (NW Mode) and Direct Mode on 2.4G/5G/6GHz band.

Connection

- IEEE 802.11a/b/g/n/ac (80 MHz BW on SISO)
- IEEE 802.11ac (160 MHz BW on SISO)
- IEEE 802.11ax HESU/HETB (160 MHz BW on SISO)
- IEEE 802.11ac (80 MHz BW on MIMO)
- Network mode/ Direct mode
- WEP, WPA/WPA2-Persona/WPA3-Personal [AP/STA]

RF

- Frequency 2.4/5/6 GHz Band
- Bandwidth 20/40/80/160 MHz
- Power Output: -120 dBm to 0 dBm*¹
- Input Level: -65 dBm to +25 dBm

Tools

- Simple GUI control with web browser
- Frame capture (signaling messages logging)
- Internet connection of DUT from IP data interface*²

*1: Output from Aux Out. -5 dBm when output from Main Port for frequencies above 6 GHz.

*2: MIMO and 11ax doesn't support IP data Interface.



Main Window – Tx Measurement



Rx Measurement

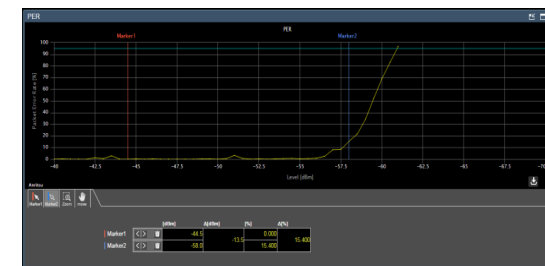

MT8862A 802.11ax 6 GHz Band Solution

- It is one box solution for RF performance test on 802.11ax 6 GHz Band (Up to 7.125 GHz).
- You also select Upgrade option for existing MT8862A.
- OTA chamber vendors have a plan to implement MT8862A to system to support 6 GHz Band.

MT8862A



Upgrade

MT8862A



One box solution advantage

- ◆ Wide TXRX dynamic range
- ◆ High Tx power
- ◆ Low Rx power available
- ◆ No external jig calibration

- ✓ Support up to 11ax
- ✓ 2.4 GHz/5 GHz Bands
- ✓ 20/40/80 MHz BW
- ✓ WEP, WPA/WPA2-Personal

- ✓ Support up to 11ax
- ✓ 2.4 GHz/5 GHz/**6 GHz Bands (up to 7.125 GHz)**
- ✓ 20/40/80/**160 MHz BW**
- ✓ WEP, WPA/WPA2-Personal/**WPA3-Personal**

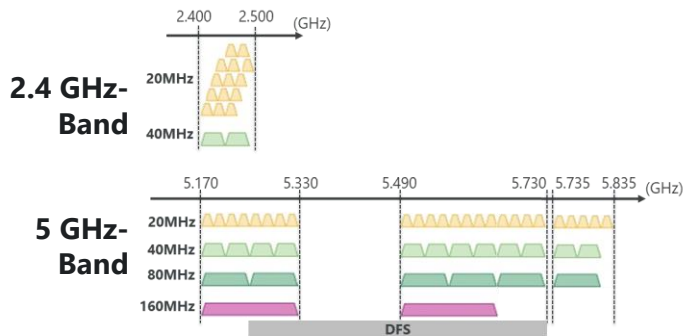

Upgrade

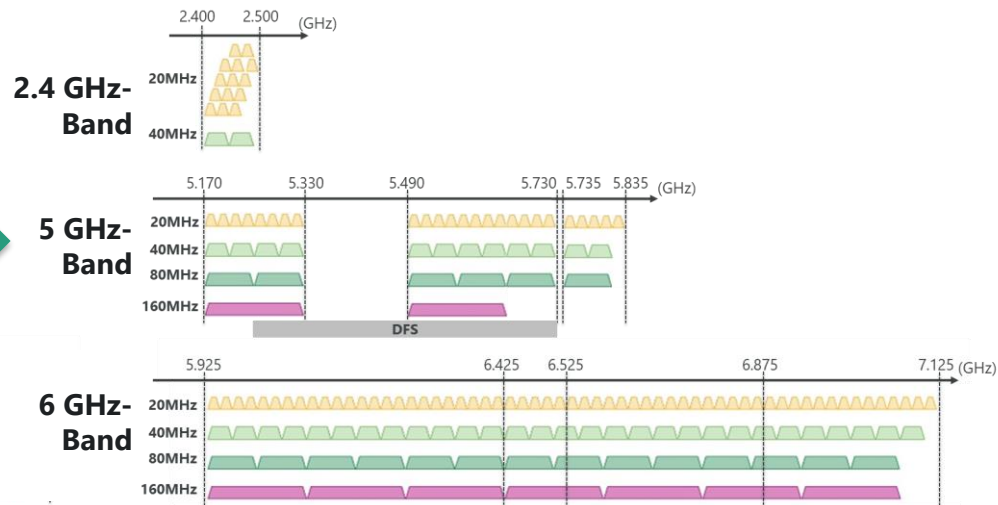

Quality Assurance of Diverse and Complex Devices

The Wireless Connectivity Test Set MT8862A supports an RF performance measurement environment under realistic operation conditions (Network Mode).



**Wireless Connectivity Test Set
MT8862A**

Wide Connectivity Support

Connections are supported in the IEEE802.11a/b/g/n/ac/ax*¹ 2x2MIMO AP and STA modes. Additionally, supporting securities, WEP, WPA-Personal and WPA2-Personal, makes measuring various devices connect in the Network Mode.

*1: 11ax supports SISO and HESU(Single user) and HETB(Multi user for STA).

*2: 11as doesn't support IP data communication.

Intuitive GUI

Setup and measurement use a browser GUI with access to Web servers from the PC controller using a Web browser. Control software installation and firmware matching are unnecessary, and there is no dependence on the PC controller OS.

Built-in IP Data Ports

Ethernet ports for IP data are built-in and IP continuity tests, such as ping between the external PC client and DUT can be performed under the same fixed-parameter conditions as at measurement. Tx measurements are also supported during IP data communication *².

Advantages of RF Measurement in Network Mode

The MT8862A Network Mode supports configuration of an RF measurement environment without test firmware, chipset control, and hardware modification.

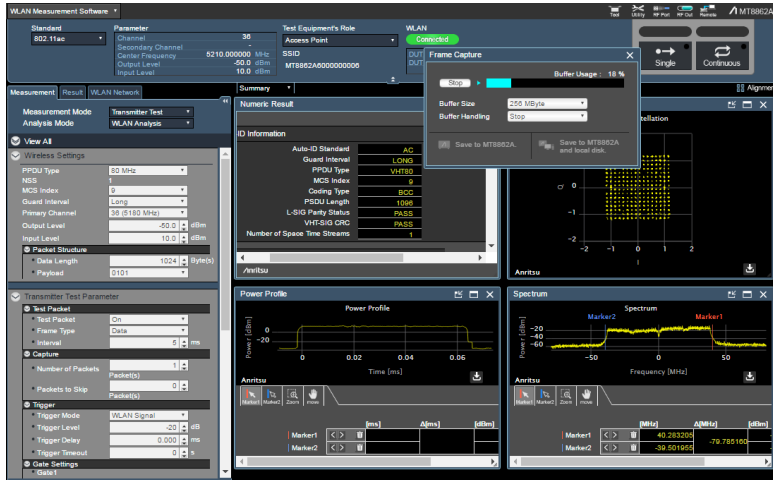

No Test Firmware

Firmware used by commercial products can be tested and RF measurements can be made without needing test firmware. RF control faults which can't be found with test firmware can be analyzed.

No Chipset Control

Chipset control required by test firmware is unnecessary and measurement is performed at the required data rate using a unique data rate control algorithm, helping unify the measurement environment for different parts used by chipsets.

No Hardware Modification

Since no interface is required for chipset control, RF tests can be run without modifying devices. This is ideal for RF measurements of devices without interfaces due to needs for miniaturization, enhanced durability, and cost control.

MT8862A's feature

Provides flexible RF tests from OTA to Conducted

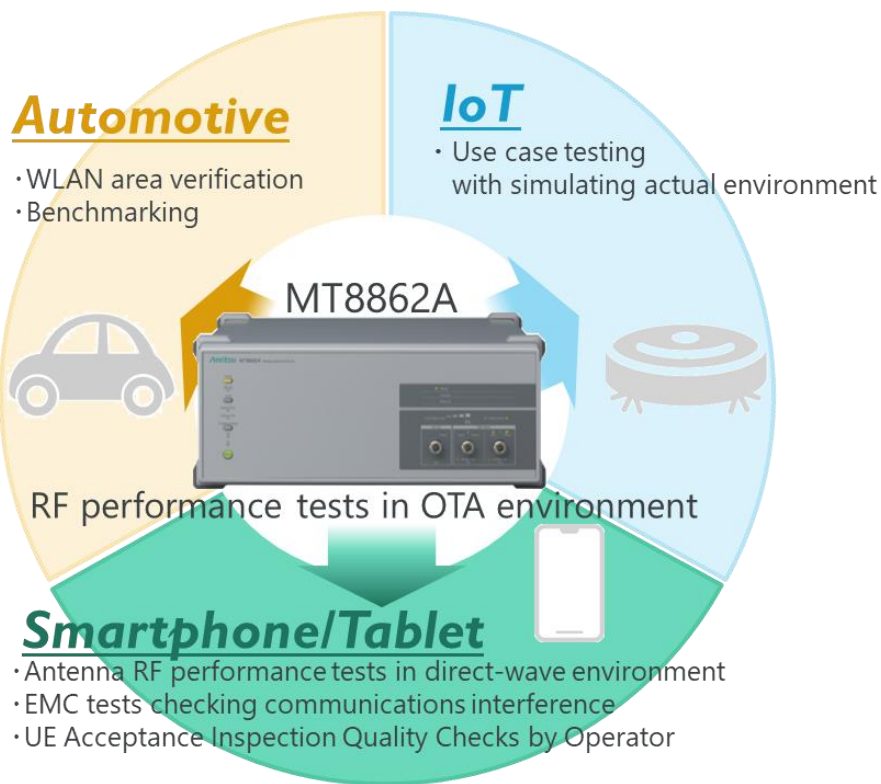

Data Rate Control Function

MT8862A can control data rate on the all standard in IEEE 802.11 a/b/g/n/ac (IEEE802.11a/b/g/n/ac/ax). The other WLAN tester cannot control data rate on 11ac/ax. Data rate control is required to check the antenna performance of DUR.

Wide Dynamic Range

MT8862A can demodulate low power and wide-band Wi-Fi signal by wide dynamic range. It is very important key feature on the OTA test environment has a big air loss. All Anritsu RF testers has this feature with priority.

MIMO measurement

MT8862A realizes 2x2 MIMO test on OTA. MT8862A is only WLAN tester to measure RF performance on MIMO OTA environment. The demand of MIMO OTA test is increasing for User experience.

*it supports 11n/ac

High Speed measurement

MT8862A measures RF performance so quickly by maintaining the connection when parameters are changed.

DUT Tx Test

- RF transmit tests are based on IEEE 802.11.
- The headers of packets received from the DUT are analyzed and RF measurements, such as power, modulation accuracy, spectrum, etc., are performed to display results. Pass/Fail evaluation of measurement results is performed based on the set reference values.
- At ACK measurement, the MT8862A sends a Test Packet to the DUT; at Data measurement, it sends a ICMP Echo Request packet. Tx measurement is performed when either the ACK or ICMP Echo Reply sent from the DUT is received.
- Packets sent using the IP data TRx ports can also be measured.

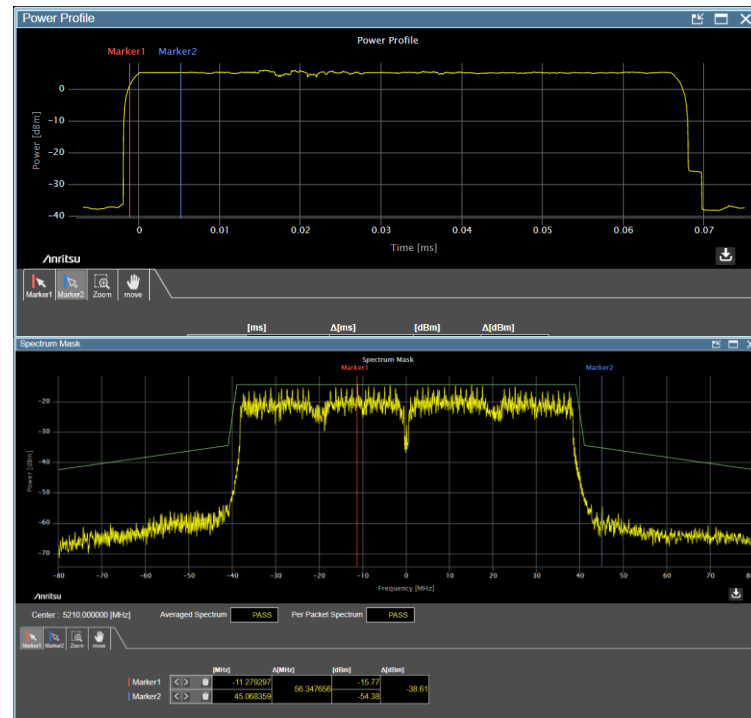
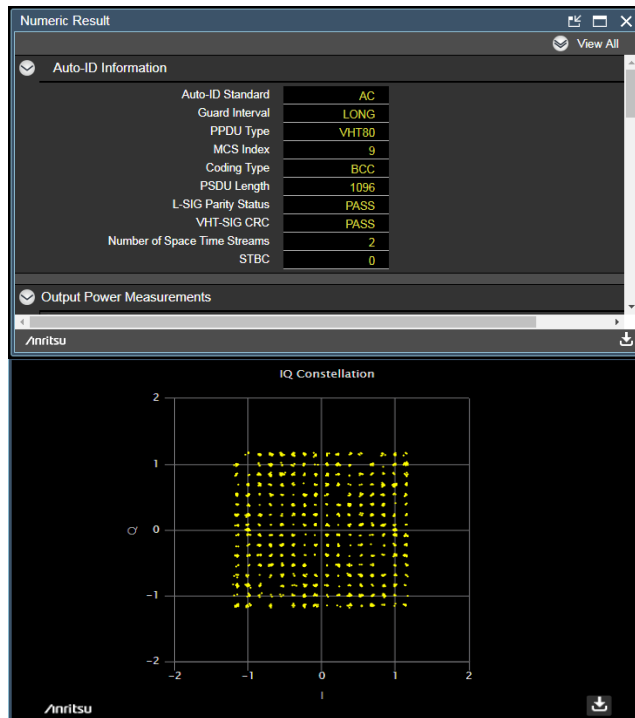

DUT Rx Test

- RF receiver tests are based on IEEE 802.11.
- PER/FRR is measured by counting ACK frames sent from DUT in response to Test Packet.
- Configuring a measurement environment is easy by changing power automatically.
- The PER (Packet Error Rate) standard of the Receiver Blocking test in ETSI EN 300 328 V 2.1.1 has been added for broadband wireless devices operating in the 2.4 GHz ISM Band, including WLAN. This test is done easily using the PER measurement function of the MT8862A and a signal generator to generate the interference wave.

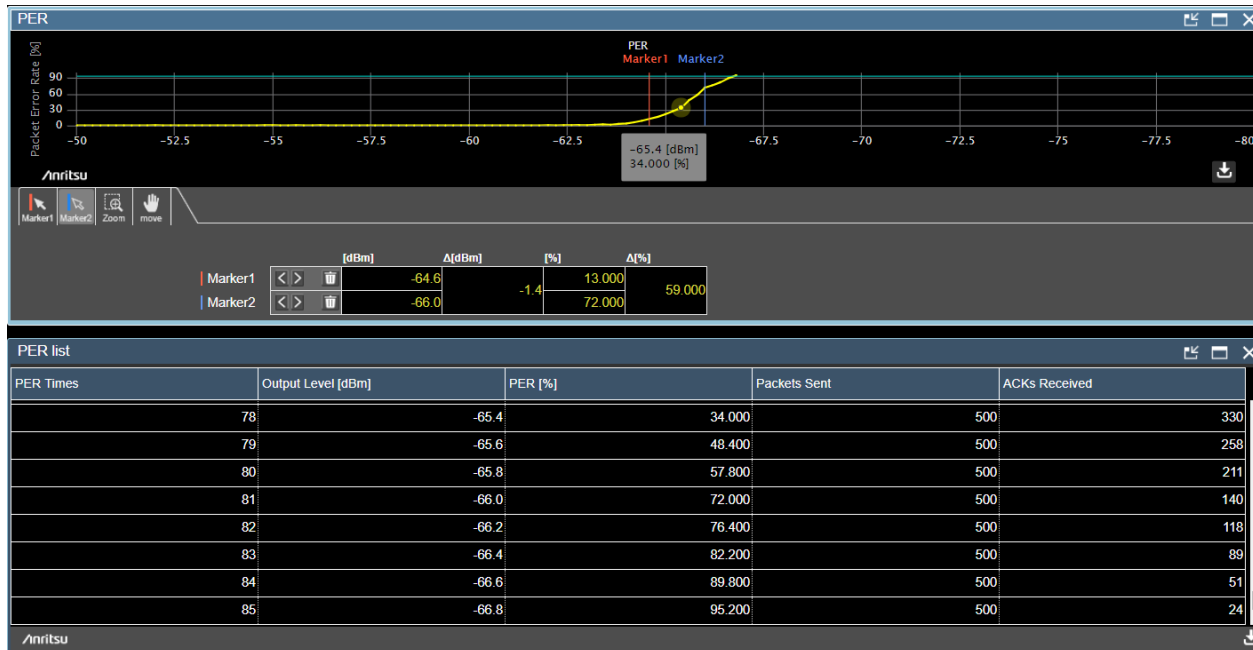

Frame Capture for Troubleshooting DUT Connections

- The WLAN Measurement Software MX886200A captures WLAN frames sent to and received from the DUT. Captured logs can be saved by the PC controller in pcap format for analysis by software such as Wireshark. This eliminates the need for a separate packet sniffer to capture WLAN frames and supports troubleshooting of WLAN frames in the RF measurement environment.

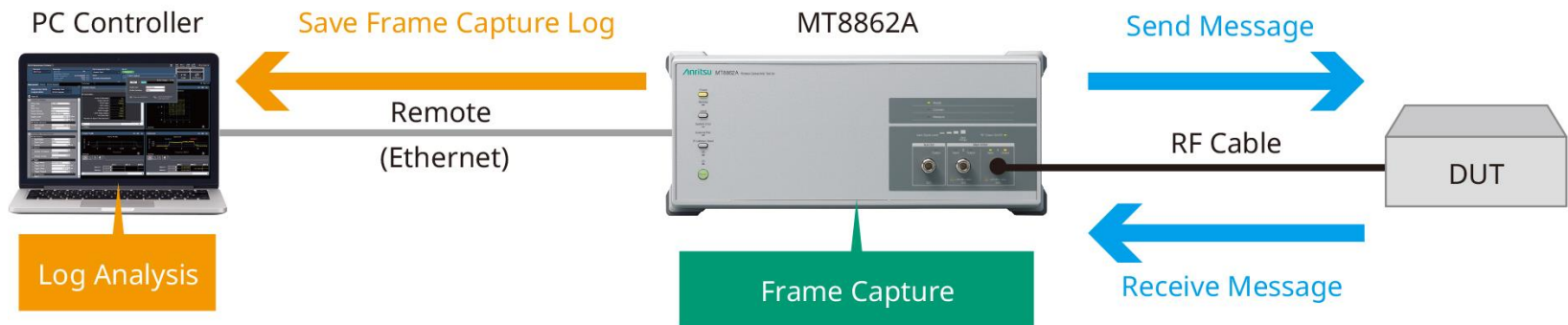

2x2MIMO Tx Test / Rx Test

- RF Performance of 2x2MIMO signals can be measured by 2 boxes in IEEE802.11n/ac.
- RF Tx test results will be showed by measurement of power and spectrum and analysis a packet header received from DUT.
- RF Rx test results will be shown as PER and FRR measurement by counting ACK frames.

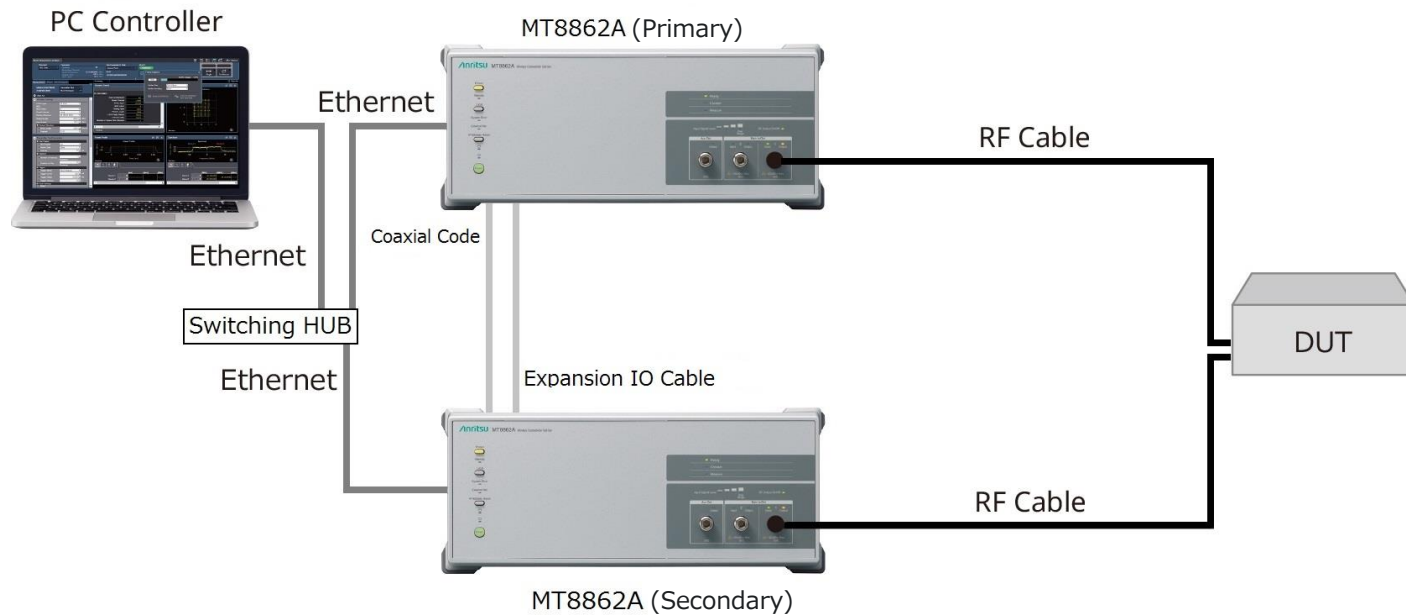



MT8862A Applications

OTA Measurements using OTA Chamber

- As WLAN applications diversify, WLAN devices and their usage environment are becoming more complex, resulting in a growing need to quantify and verify that antenna characteristics meet the design specifications by testing antenna characteristics, such as TX power range, receiver sensitivity, etc.
- Anritsu supports an OTA measurement test environment with OTA chamber vendors for measuring the reception power range and receiver sensitivity, such as TRP/TIS, to validate RF performance in WLAN final-use environments.

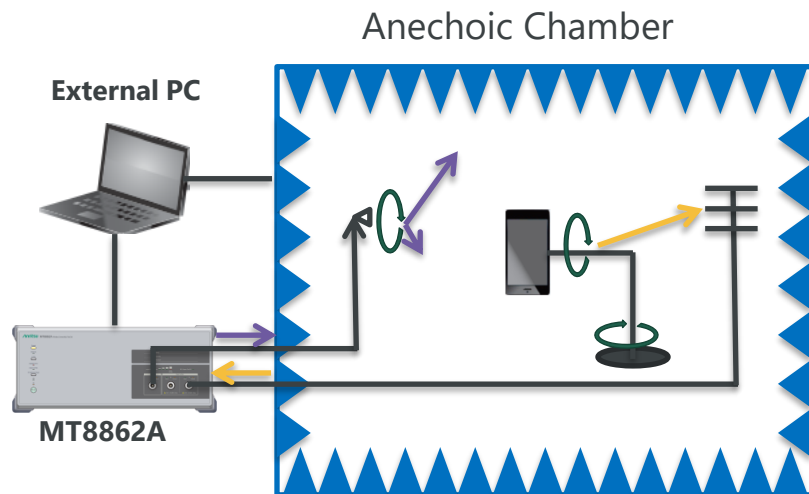

→ Downlink Signal → Uplink Signal

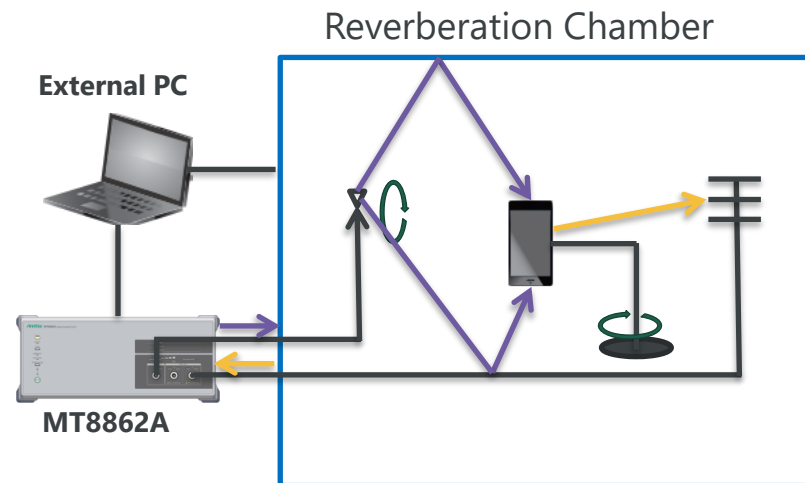

→ Downlink Signal → Uplink Signal

Regulatory Test

Overview of ETSI Regulatory Test

Originally, the ETSI standard covered tests of transmitted power, spurious emission and etc., which were measured with power meter and spectrum analyzer. However, "Receiver Blocking Test" has been added in 2015, so a **Signaling Unit** or **Companion Device** is required as the opposing equipment. This test item requires the calculation of the Packet Error Rate while communicating under the specific conditions of **Minimum Bandwidth** and **Minimum Data Rate**, so the MT8862A Network Mode works effectively.

And, the EMC test, updated in September 2020, also uses PER as an indicator of performance, increasing the need for Signaling measurement instruments.

Standard Number

RF testing for 2.4 GHz-Band : EN 300 328 V2.2.2

RF testing for 5 GHz-Band : EN 301 893 V2.1.1

EMC testing : EN 301 489-17 V3.2.4

Why MT8862A is better?

- Using the Companion Device, it is difficult to control to a given bandwidth and data rate.
- It's also difficult to measure PER without using the Signaling Unit.
- It takes a lot of resources and time to build an environment for communication state control and communication quality monitoring using devices other than the Signaling Unit.

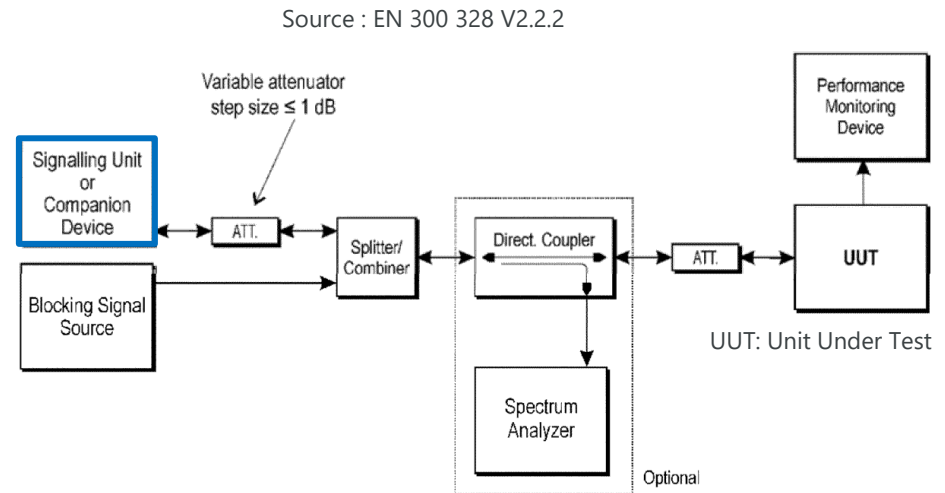

Test Set-up for receiver blocking

IP Data Transfer

- The Ethernet port on the back panel of the MT8862A can be used for exchanging IP data with an external server.
- IP connections between the client PC connected to the DUT and the external server connected to the MT8862A can be checked using the ping function, etc.
- Connections can be checked and RF measurements can be made under fixed parameter conditions, such as data rate.
- When it is necessary to access a specific server on the Internet at DUT connection, the MT8862A can also be used for connection maintenance purposes.
- IP Data transfer supports IEEE 802.11a/b/g/n/ac.

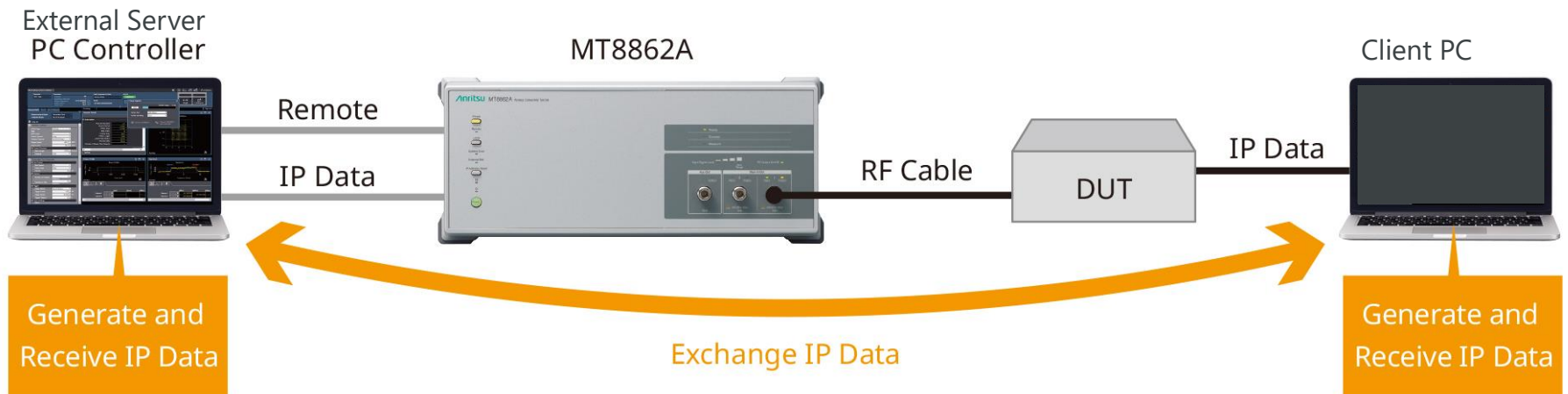

All Frame Power measurement

Purpose: Measure Tx Power before connection is established. Because some devices output max power during the period.

Target Customer : Smartphone/PC/Tablet, Operators, Automotive, CE, Test House etc

MT8862A measures output power, specified on the radio low, of all frame including connection attempt period by this function.

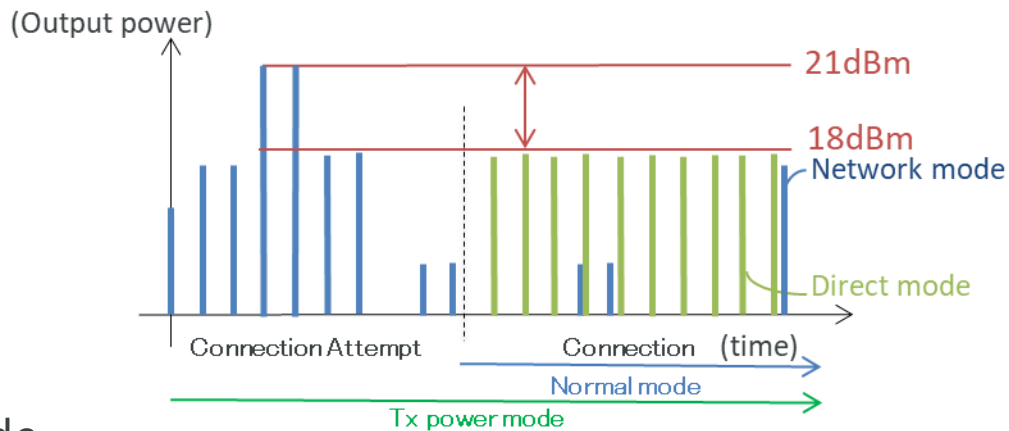

Normal mode

RF measurement starts after call connection established, with Single/Continuous buttons. This mode complies with IEEE procedure.

Tx Power mode

RF measurement starts from before connection established at all frames.

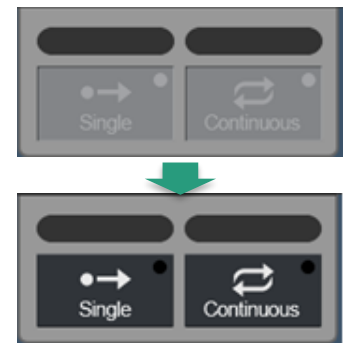

Output Power Measurements			
Transmit Power			
	Average	Maximum	Minimum
Gate1 Average Power [dBm]	-21.47	-21.43	-21.70
Gate1 Peak Power [dBm]	-12.92	-12.81	-13.08
Crest Factor			
	Average	Maximum	Minimum
Gate1 [dB]	8.56	8.63	8.41

Average Power (Average, Max, Min)
Peak Power (Average, Max, Min)
Crest Factor (Average, Max, Min)



Appendix

MT8862A – Key Specifications



Connectivity Test Set MT8862A

- RF Input/Output: Main 1, Main 2, Aux (Aux: output only)
- Frequency Range: 2.4 to 2.5 GHz, 5.0 to 6.0 GHz , 6.0 to 7.3 GHz (in 1 Hz steps)
- Input Level Range: –65 to +25 dBm (in 0.1 dB steps)
- Output Level Range: –120 to 0 dBm (in 0.1 dB steps)
- Dimensions: 426 (W) × 177 (H) × 390 (D) mm (excluding protruding parts)
- Mass: 14 kg max.
- Power Supply: 100 to 120 Vac/200 to 240 Vac, 50/60 Hz, ≤ 350 VA
- Environmental Conditions: +5°C to +45°C (operating), –20°C to +60°C (storage)

WLAN Connectivity (1/2)

	802.11a	802.11b	802.11g
Frequency Range	5180 MHz to 5885 MHz	2412 MHz to 2484 MHz	2412 MHz to 2484 MHz
Operation Mode	-	-	ERP-OFDM
Modulation	OFDM(BPSK, QPSK, 16QAM, 64 QAM)	DSSS, CCK	OFDM(BPSK, QPSK, 16QAM, 64 QAM)
Data Rate	6, 9, 12, 18, 24, 36, 48, 54 Mbps	1, 2, 5.5, 11 Mbps	6, 9, 12, 18, 24, 36, 48, 54 Mbps
Security* ²	WEP, WPA-Personal, WPA2-Personal, WPA3-Personal		
	802.11n	802.11ac* ¹	
Frequency Range	2412 MHz to 2484 MHz 5180 MHz to 5885 MHz	5180 MHz to 5885 MHz	
Bandwidth	20 MHz, 40 MHz	20 MHz, 40 MHz, 80 MHz, 160 MHz* ³	
MCS	MCS0 to MCS7	MCS0 to MCS9	
FEC	BCC	BCC	
PPDU Format	HT-mixed, HT-greenfield	VHT	
Guard Interval	Long, Short	Long, Short	
RF Chain	Single (SISO), 2x2MIMO* ⁴	Single (SISO) , 2x2MIMO* ⁴	
Security* ²	WEP, WPA-Personal, WPA2-Personal, WPA3-Personal		

*1: 802.11ac connection requires MX886200A-001.

*4: 2x2MIMO requires MX886200A-010.

*2: Secure connections require the MX886200A-020.

*3: 160 MHz Bandwidth requires MX886200A-030.

WLAN Connectivity (2/2)

	802.11ax*1
Frequency Range	2412 MHz to 2484 MHz 5180 MHz to 5885 MHz 5995 MHz to 7115 MHz*3
Bandwidth	20 MHz, 40 MHz, 80 MHz, 160 MHz*4
MCS	MCS0 to MCS11
FEC	LDPC, BCC
PPDU Format	HE SU, HE TB
GI+ LTF Size	HE_SU: "0.8us GI, 1xHE-LTF", "0.8us GI, 2xHE-LTF", "1.6us GI, 2xHE-LTF", "0.8us GI, 4xHE-LTF", "3.2us GI, 4xHE-LTF" HE_TB: "1.6us GI, 2xHE-LTF", "3.2us GI, 4xHE-LTF"
RF Chain	Single (SISO)
Security*2	WEP, WPA-Personal, WPA2-Personal, WPA3-Personal

*1: 802.11ax connection requires MX886200A-002.

*2: Secure connections require the MX886200A-020.

*3: For this frequency range only, the transmit level setting range of the Main 1/2 connector is -120 to -5 dBm.

*4: 160 MHz Bandwidth requires MX886200A-030.

Comparison with MT8860C



	MT8862A	MT8860C
WLAN Connectivity	802.11a/b/g/ n/ac/ax 160 MHz bandwidth SISO / 2x2MIMO *1	802.11a/b/g 20 MHz bandwidth SISO
Operating Mode	Network mode [AP/STA]	Network mode (AP/STA/ AdHoc) Direct mode
Security	WEP, WPA-Personal, WPA2-Personal, WPA3-Personal	-
RF In/Out	Main In/Out (N-Type) x 2 Aux Out (N-Type)	Main In/Out (N-Type) Interference In, WLAN Ref In (N-Type)
RF Maximum Output Level	0 dBm [2.4 / 5 / 6 GHz band] *2	-3 dBm [2.4 GHz band]/ -8 dBm [5 GHz band]
Control Software	Control GUI on web browser	LANLook, CombiTest (Windows app)
Remote Interface	Ethernet (VXI-11/HiSLIP /Raw)	GPIO , Ethernet
Remote Command	MT8862A Native	MT8860C Native
IP Data Interface	Gbit Ethernet *1	-
Packet Log	pcap Output	-
Size	1MW 4U 390 mm	3/4MW 4U 350 mm

Red: Additional items, **Bold:** Changed items

*1: It doesn't support 11ax.

*2: Aux Out

- Supports 802.11n/ac/ax and AP/STA security connections for more DUT measurements
- Improved usability with separate Tx and Rx RF ports, higher maximum output level, and OTA measurements
- Renewed control software and simpler DUT connection for easier measurement
- Built-in IP data interface for IP continuity tests in reproducible test environment
- Frame capture logs and messaging logging

Supported status of 11ax

11ax has four frame formats (PPDU format*). MT8862A supports two use cases, and will add one use case.

*PPDU= PLCP Protocol Data Unit

Single User (STA)

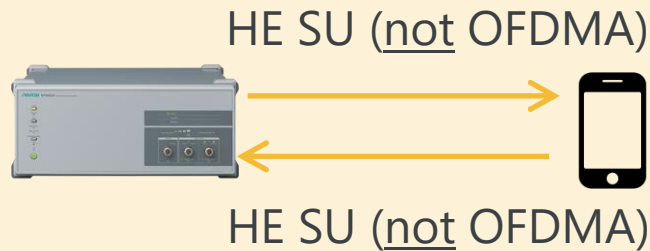

Single User (AP)

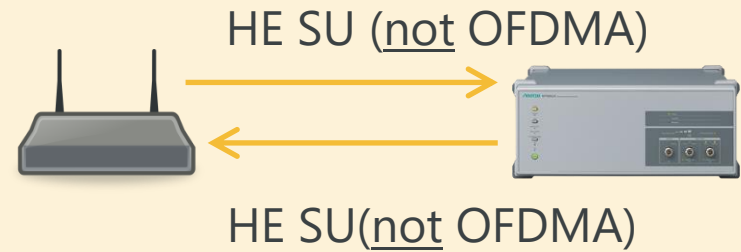

Multi User(STA)

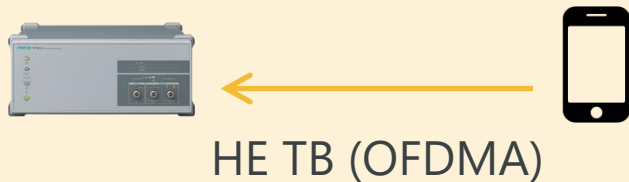

*RX test is not defined with IEEE

Multi User(AP)

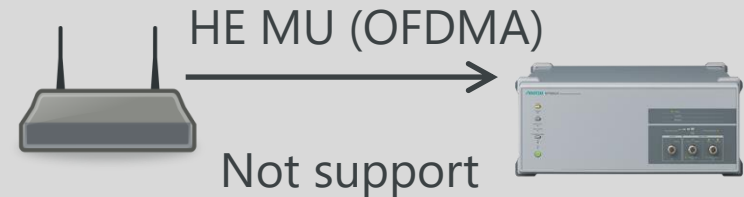

*RX test is not defined with IEEE

Single User for IoT(DUT)

HE ER SU (Not support)

Single User for IoT(AP)

HE ER SU (Not support)

11ax Key feature – HE TB RU Allocation

With support for OFDMA in IEEE802.11ax HE TB, the MT8862A can configure the DUT to transmit specific RU allocations in the channel.

160 MHz HE PPDU

26-tone RU

52-tone RU

106-tone RU

242-tone RU

484-tone RU

996-tone RU

2x996-tone RU

Side: Lower

160MHz: 68

Primary Channel: 5.5975 MHz

Output Level: -50.0 dBm

Input Level: 10.0 dBm

Packet Structure: Data Length: 1024, Payload: 0101

Transmitter Test Parameter: Measurement Execution: Connected, Test Packet: On, Frame Type: Data, Interval: 5 ms

Multi-user (DUT)

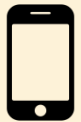

HE TB(OFDMA)

*RX test undefined by IEEE

802.11ax Option Test Coverage

Category	Chapter	Title	Detail	DUT	Measurement
Transmit requirements for an HE TB PPDU	27.3.15.3	Pre-correction accuracy requirements	Transmit power and RSSI measurement accuracy	STA	HETB
			carrier frequency offset error	STA	HETB
			symbol clock error	STA	HETB
			the arrival time of the HE TB PPDU at the AP	STA	HETB
Transmit specification	27.3.19.1	Transmit spectral mask ^{*1}		AP/STA	All PPDU Format ^{*2}
	27.3.19.2	Spectral flatness		AP/STA	All PPDU Format ^{*2}
	27.3.19.3	Transmit center frequency and symbol clock frequency tolerance		AP/STA	All PPDU Format ^{*2}
	27.3.19.4.2	Transmit center frequency leakage		AP/STA	All PPDU Format ^{*2}
	27.3.19.4.3	Transmitter constellation error		AP/STA	All PPDU Format ^{*2}
	27.3.19.4.4	Transmitter modulation accuracy (EVM) test		AP/STA	All PPDU Format ^{*2}
Receiver specification	27.3.20.2	Receiver minimum input sensitivity		AP/STA	HESU
	27.3.20.3	Adjacent channel rejection		AP/STA	HESU
	27.3.20.4	Nonadjacent channel rejection		AP/STA	HESU
	27.3.20.5	Receiver maximum input level		AP/STA	HESU

*1: Frequency SPAN of 802.11ax supports up to ± 80 MHz

*2: HEMU Tx is not supported

MT8862A – RF Input/Output Port Specifications

- Supports up to 0 dBm output in 3 bands for easier configuration of OTA measurement environment.
- A simple system can be configured even when an external amplifier is required by separating Tx/Rx using Aux Output.
- DUTs can be switched during measurement by using the Main 1 and Main 2 ports, supporting automated measurement of multiple DUTs.
- The input level range : -65 to + 25 dBm (Main 1/2).
- The output range : -120 to 0 dBm (Aux, 2.4/5/6 GHz Band)
 - 120 to 0 dBm (Main1/2, 2.4/5 GHz Band)
 - 120 to -5 dBm (Main1/2, 6 GHz Band)

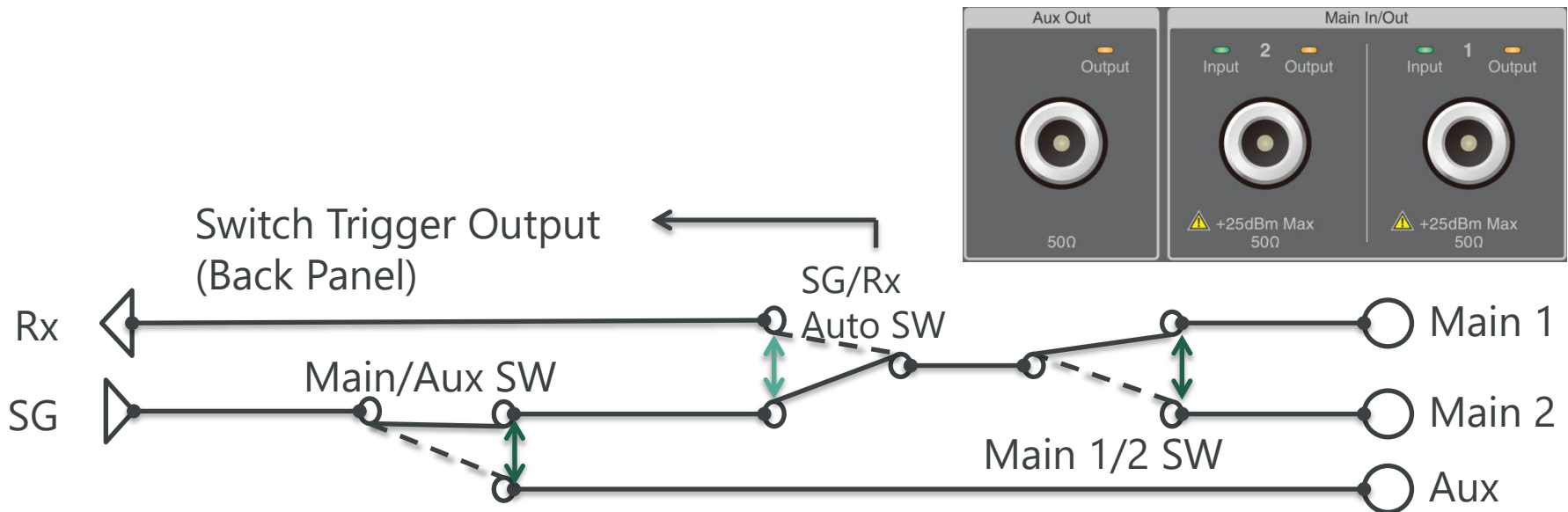

Remote Control Environment

- Using the MT8862A, remote-control protocols, such as HiSLIP, VXI11, etc., for controlling instruments using the general-purpose Raw-Socket connection method, can be selected to match an existing remote-control environment.
- The same remote-control commands are used for the GUI running on the Web browser and the GUI remote control command log can also be captured. Creation times are greatly reduced by using remote-control command sequences.
- In addition, sample sequences are also provided for the SmartStudio Manager MX847503A for the MT8862A.



1. Making & Selecting test items

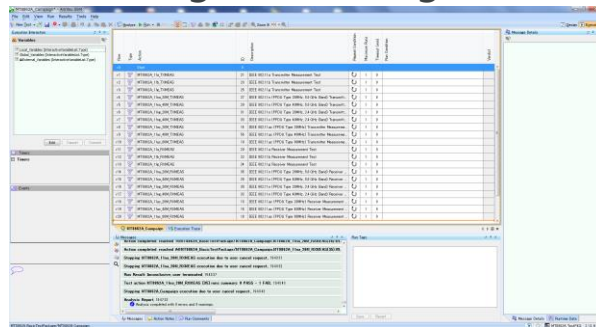

2. Run

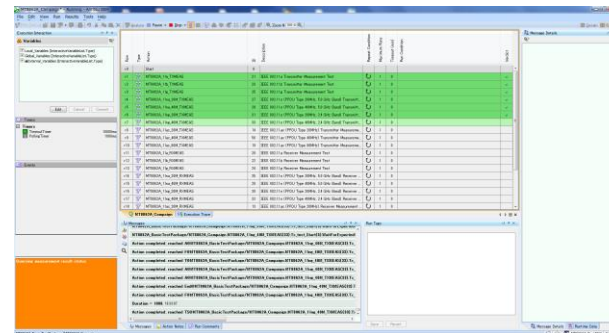

5 GHz Band DFS testing

WLAN, weather radar, marine radar, etc., use the same frequency bands in the 5.3 GHz (Ch52-Ch64[W53/U-NII-2A]) and 5.6 GHz bands (Ch100-Ch144[W56/U-NII-2C]), so the DFS (Dynamic Frequency Selection) technology is used to prevent signal interference when these signals are detected.

Combining the Vector Signal Generator MG3710E with the waveform pattern product supports the DFS test defined by TELEC, ETSI, and FCC for 5 GHz band WLAN devices.

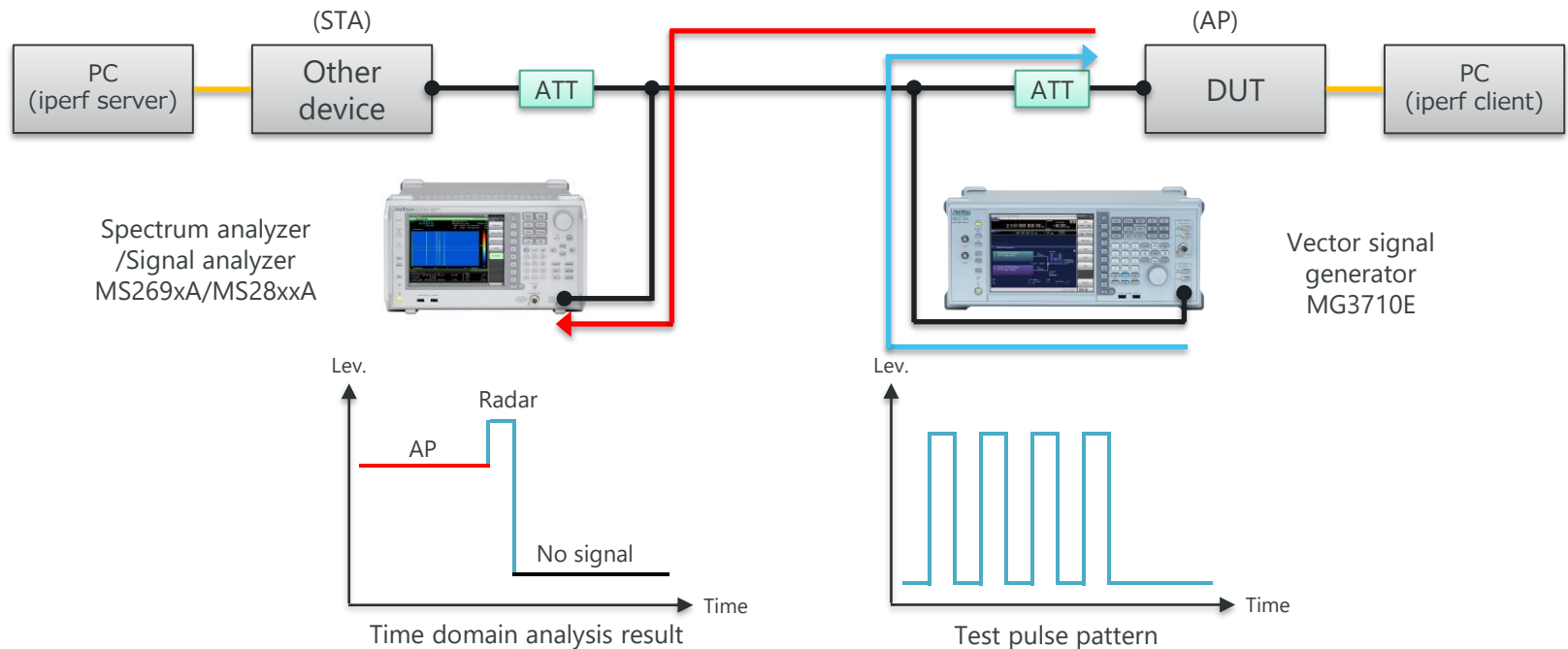

Documents and Firmware Web Downloads

- Anritsu Web Site
 - Download catalogs, product introduction, etc.
 - Open access by anyone

<https://www.anritsu.com/en-GB/test-measurement/products/mt8862a>

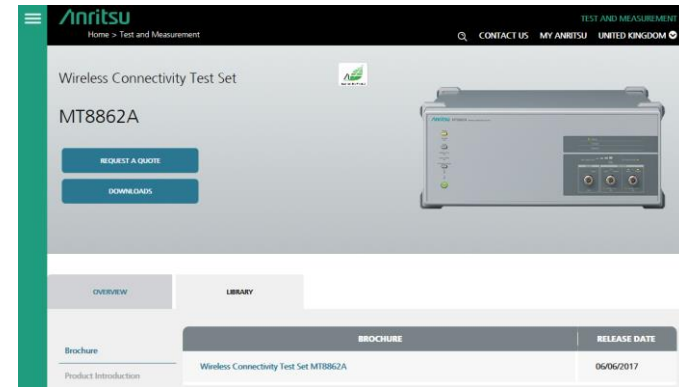

- My Anritsu
 - Download operation manuals, firmware, tools, etc.
 - Requires creation of My Anritsu account and product registration

<https://login.anritsu.com/signin?>

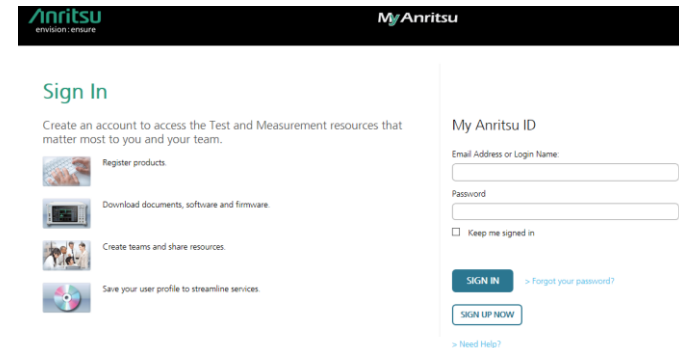

The Anritsu logo is displayed in a bold, teal, sans-serif font. Below it, the tagline "Advancing beyond" is written in a smaller, black, sans-serif font. The background features a light green gradient with several curved, parallel lines in shades of green and yellow on the right side.

Anritsu

Advancing beyond