







Introduction

The **RGPS-R9244GP+-P** is a Layer-3 Gigabit managed Ethernet switch with 24x10/100/1000Base-T(X) IEEE802.3at P.S.E. ports and 4x1G/10GBase-X SFP+ ports. The P.S.E-enabled ports are able to provide sufficient power for power-hungry devices with up to 30w per port. The switch supports various Ethernet redundancy protocols such as O-Ring (recovery time < 30ms over 250 units of connection) and MSTP (RSTP/STP compatible) to protect mission-critical applications from network interruptions or temporary malfunctions. With dual power inputs for redundancy, the switch has an operating temperature from -40°C to 60°C. It can be managed via ORing's proprietary Open-Vision software as well the Web-based interface, Telnet and command line interface.

Package Contents

The device is shipped with the following items. If any of these items is missing or damaged, please contact your customer service representative for assistance.



Contents	Pictures	Number
RGPS-R9244-GP+-P		X 1
Console Cable		X 1
CD		X 1
QIG		X 1
Screw (M4 X6)		X 6
Rack-mounted kit (L&R)		X 1
Power cord		X 1

Preparation

Before you begin installing the switch, make sure you have all of the package contents available and a PC with Microsoft Internet Explorer 6.0 or later, for using web-based system management tools.

Safety & Warnings

Elevated Operating Ambient: If installed in a closed or multi-unit rack assembly, the operating ambient temperature of the rack environment may be greater than room ambient. Therefore, consideration should be given to installing the equipment in an environment compatible with the maximum ambient temperature (T_{ma}) specified by the manufacturer.

-  **Reduced Air Flow:** Installation of the equipment in a rack should be such that the amount of air flow required for safe operation of the equipment is not compromised.
-  **Mechanical Loading:** Mounting of the equipment in the rack should be such that a hazardous condition is not achieved due to uneven mechanical loading.
-  **Circuit Overloading:** Consideration should be given to the connection of the equipment to the supply circuit and the effect that overloading of the circuits might have on overcurrent protection and supply wiring. Appropriate consideration of equipment nameplate ratings should be used when addressing this concern.

Dimension

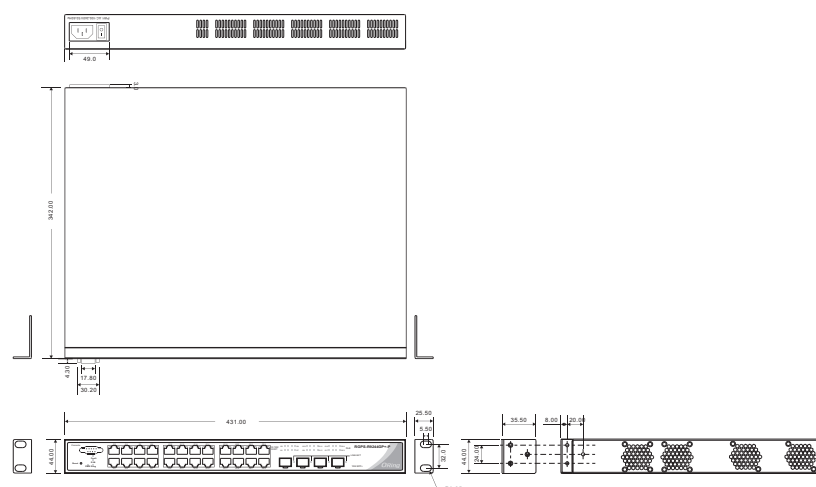

Panel Layouts

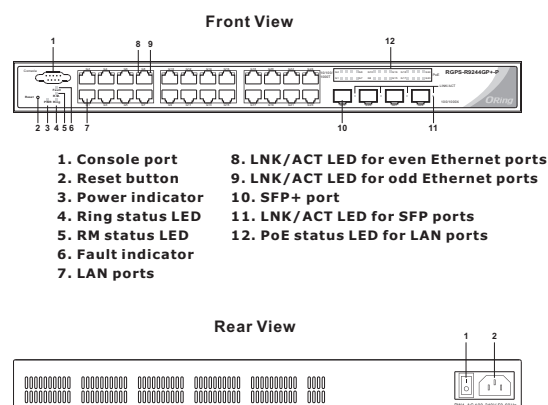

Installation

Rack-mounting

- Step 1:** Install left and right front mounting brackets to the switch using three screws on each side.
- Step 2:** With front brackets orientated in front of the rack, fasten the brackets to the rack using two more screws.

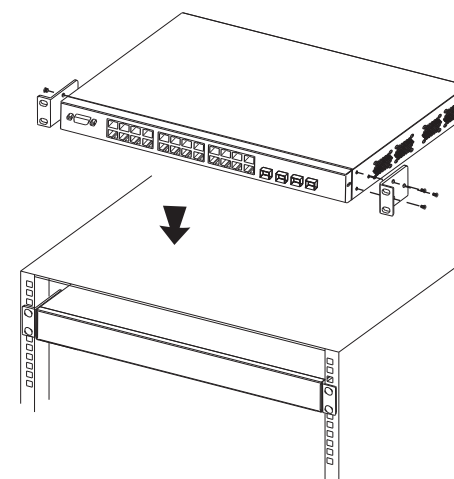

Network Connection

The series have standard Ethernet ports. According to the link type, the switch uses CAT 3, 4, 5, 5e UTP cables to connect to any other network devices (PCs, servers, switches, routers, or hubs). Please refer to the following table for cable specifications.

Cable Types and Specifications:

Cable	Type	Max. Length	Connector
10BASE-T	Cat. 3, 4, 5 100-ohm	UTP 100 m (328 ft)	RJ-45
100BASE-TX	Cat. 5 100-ohm UTP	UTP 100 m (328 ft)	RJ-45
1000BASE-T	Cat. 5 / Cat. 5e 100-ohm UTP	UTP 100 m (328 ft)	RJ-45

With 10/100BASE-T(X) cables, pins 1 and 2 are used for transmitting data, and pins 3 and 6 are used for receiving data. The device also supports auto MDI/MDI-X operation. You can use a cable to connect the switch to a PC

For pin assignments for different types of cables, please refer to the following tables.

10/100Base-T(X) P.S.E. RJ-45 port	
Pin Number	Assignment
# 1	TD+ with PoE Power input +
# 2	TD- with PoE Power input +
# 3	RD+ with PoE Power input -
# 6	RD- with PoE Power input -

1000Base-T P.S.E. RJ-45 port	
Pin Number	Assignment
# 1	BI_DA+ with PoE Power input +
# 2	BI_DA- with PoE Power input +
# 3	BI_DB+ with PoE Power input -
# 4	BI_DC+
# 5	BI_DC-
# 6	BI_DB- with PoE Power input -
# 7	BI_DD+
# 8	BI_DD-

Configurations

After installing the switch and connecting cables, start the switch by turning on power. The green power LED should turn on.

LED indication table

LED	Color	Status	Description
PWR	Green	On	System power is connected
R.M	Green	On	Device is operating as a ring master
Ring	Green	On	Ring is enabled and device is running in Ring mode
		Blinking	Ring structure is broken
Fault	Amber	On	Errors (power failure or port malfunctioning)
10/100/1000Base-T(X) RJ45 port			
Link/Act	Green	On	Port is linked and runs at 1000Mbps
		Amber	Port is linked and runs at 10/100Mbps
PoE	Green	On	Power is supplied over Ethernet cable
1G/10G SFP port			
Link/Act	Green	On	Port is connected
		Blinking	Transmitting data

1. Launch the Internet Explorer and type in IP address of the switch. The default static IP address is **192.168.10.1**

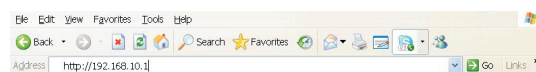

2. Log in with default user name and password (both are **admin**). After logging in, you should see the following screen. For more information on configurations, please refer to the user manual. For information on operating the switch using ORing's Open-Vision management utility, please go to ORing website.

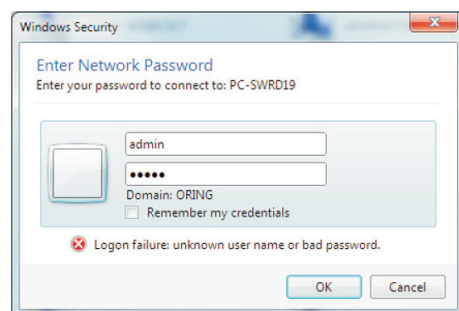

Resetting

To reboot the switch, press the Reset button for 2-3 seconds.

To restore the switch configurations back to the factory defaults, press the Reset button for 5 seconds.

Specifications

ORing Switch Model	RGPS-R9244GP+-P
Physical Ports	
10/100/1000Base-T(X) with P.S.E. Ports in RJ45 Auto MDI/MDIX	24
1G/10GBase-X with SFP+ port	4
Technology	
Ethernet Standards	IEEE 802.3 for 10Base-T IEEE 802.3u for 100Base-TX IEEE 802.3z for 1000Base-X IEEE 802.3ab for 1000Base-T IEEE 802.3ae for 10Gigabit Ethernet IEEE 802.3x for Flow control IEEE 802.3ad for LACP (Link Aggregation Control Protocol) IEEE 802.1p for COS (Class of Service) IEEE 802.1Q for VLAN Tagging IEEE 802.1w for RSTP (Rapid Spanning Tree Protocol) IEEE 802.1s for MSTP (Multiple Spanning Tree Protocol) IEEE 802.1x for Authentication IEEE 802.1AB for LLDP (Link Layer Discovery Protocol) IEEE 802.3at PoE specification (up to 30 Watts per port for P.S.E.) -40~55°C : PoE output 720W Max. 55~60°C : PoE output 360W Max.
MAC Table	8K
Priority Queues	8
Processing	Store-and-Forward
Switch Properties	Switch latency: 7 us Switch bandwidth: 128Gbps Max. Number of Available VLANs: 256 IGMP multicast groups: 128 for each VLAN Port rate limiting: User Define
Jumbo frame	Up to 9.6K Bytes
Security Features	Device Binding security feature Enable/disable ports, MAC based port security Port based network access control (802.1x) Single 802.1x and Multiple 802.1x MAC-based authentication QoS assignment Guest VLAN MAC address limit TACACS+ VLAN (802.1Q) to segregate an secure network traffic Radius centralized password management SNMPv3 encrypted authentication and access security Https / SSH enhance network security Web and CLI authentication and authorization Authorization (15 levels) IP source guard
Software Features	Hardware routing, RIP and static routing IEEE 1588v2 clock-synchronization IEEE 802.1D Bridge, auto MAC address learning/aging and MAC address (static) Multiple Registration Protocol (MRP) MSTP (RSTP/STP compatible) Redundant Ring (O-Ring) with recovery time less than 30ms over 250 units TOS/Diffserv supported Quality of Service (802.1p) for real-time traffic VLAN (802.1Q) with VLAN tagging IGMP v2/v3 Snooping IP-based bandwidth management Application-based QoS management DOS/DDoS auto prevention Port configuration, status, statistics, monitoring, security DHCP Server/Client DHCP Relay Modbus TCP DNS client proxy SMTP Client
Network Redundancy	O-Ring, Open-Ring, O-Chain, MRP, MSTP (RST/STP compatible)
RS-232 Serial Console Port	RS-232 in DB-9 connector with console cable. 115200bps, 8, N, 1
Power	
Overload current protection	100~240VAC with power socket
Power supply	1000 Watts power supply included (720W power budget)
Power consumption(Typ.)	75 Watts (PoE output not included)
Overload current protection	Present
Physical Characteristic	
Enclosure	19 inches rack mountable
Dimension (W x D x H)	431 (W) x 342 (D) x 44 (H) mm (16.97 x 13.47 x 1.73 inches)
Weight (g)	6520g
Environmental	
Storage Temperature	-40 to 85°C (-40 to 185°F)
Operating Temperature	-40 to 60°C (-40 to 140°F)
Operating Humidity	5% to 95% Non-condensing

Regulatory Approvals	
EMI	FCC Part 15, CISPR (EN55022) class A
EMS	EN61000-4-2 (ESD)
	EN61000-4-3 (RS)
	EN61000-4-4 (EFT)
	EN61000-4-5 (Surge)
	EN61000-4-6 (CS)
	EN61000-4-8
	EN61000-4-11
Shock	IEC60068-2-27
Free Fall	IEC60068-2-32
Vibration	IEC60068-2-6
Safety	EN60950-1
Warranty	5 years

ORing

 Copyright© 2014 ORing
All rights reserved.

ORing Industrial Networking Corp.

 TEL: +886-2-2218-1066 Website: www.oring-networking.com
 FAX: +886-2-2218-1014 E-mail: support@oring-networking.com