

User Guide
6643-22901

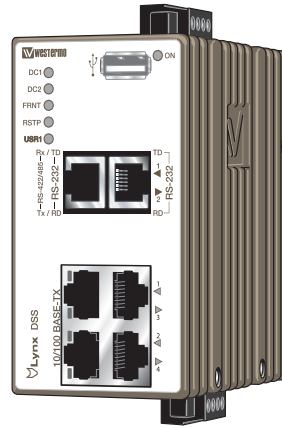

Lynx DSS

L106-S2 EX / L206-S2 EX



**Industrial Ethernet
6-port Device Server Switch**

www.westermo.com

Safety



Warning

Do not open connected unit. Hazardous voltage may occur within this unit when connected to power supply.

Note that this unit can be connected to two different power sources.

When this unit is operated at an ambient temperature above +55°C (+131°F), the External Surface of Equipment may exceed Touch Temperature Limit according to EN/IEC/UL 60950-1.

To reduce the risk of fire, use only No. 26 AWG or larger telecommunication line cord.

For more information see General safety 100-5001.



Software tools

Related software tools are available in the folder software tools under technical support on the Westermo website.

License Information

This device contains public available software which is under the GPL license.

For more information see legal.pdf included with all firmware releases.

This product includes software developed by the OpenSSL Project for use in the **OpenSSL Toolkit**. <http://www.openssl.org>

Legal information

The contents of this document are provided "as is". Except as required by applicable law, no warranties of any kind, either express or implied, including, but not limited to, the implied warranties of merchantability and fitness for a particular purpose, are made in relation to the accuracy and reliability or contents of this document. Westermo reserves the right to revise this document or withdraw it at any time without prior notice.

Under no circumstances shall Westermo be responsible for any loss of data or income or any special, incidental, and consequential or indirect damages howsoever caused.

More information about Westermo can be found at the following Internet address:

<http://www.westermo.com>



ATEX certification number

Baseefa12ATEX0119X

Standards

EN 60079-0:2012, EN 60079-15:2010.

Certification code

Ex nA IIC T3 Gc ($-40^{\circ}\text{C} \leq \text{Ta} \leq +70^{\circ}\text{C}$)

ATEX code

 II 3G

Specific Conditions of Use

The equipment must be installed in an area of not more than pollution degree 2 in accordance with IEC/EN 60664-1, and in an enclosure that provides a minimum degree of protection of at least IP54 and complies with the relevant requirements of EN 60079-0 and EN 60079-15.

All external connections to the equipment and, where applicable, the SFP modules must not be inserted or removed unless either the area in which the equipment is installed is known to be non-hazardous, or the circuits connected have been de-energized.

The network cables once installed must be properly fixated by the use of cable ties or similar to reduce the risk of accidentally withdrawing the plugs.

Equipment input parameters

Power Connector: +DC1, +DC2 & –COM

Working Voltage Range = 24 V to 48 VDC.

I/O Connector: 'Status +' & 'Status –' and 'Digital in +' and 'Digital in –'

Maximum I/P Voltage = 60 VDC.



ATEX-Zulassungsnummer

Baseefa12ATEX0119X

Standards

EN 60079-0:2012, EN 60079-15:2010

Zertifizierungscode

Ex nA [op ist T4] IIC T3 Gc ($-40\text{ °C} \leq T_a \leq +70\text{ °C}$)

ATEX-Code

 II 3G

Spezifische Einsatzbedingungen

Die Geräte müssen in einem Bereich welcher einem maximalen Verschmutzungsgrad der Stufe 2 gemäß IEC/EN 60664-1 entspricht und in einem Gehäuse, das einen Schutzgrad von mindestens IP54 bietet und die relevanten Anforderungen von N 60079-0 und EN 60079-15 erfüllt, installiert werden.

Alle äußeren Anschlüsse des Gerätes und auch die SFP-Module dürfen nur dann verbunden oder getrennt werden, wenn entweder der Bereich, in dem das Gerät installiert ist, nachweislich ungefährlich ist, oder die verbundenen Stromkreise spannungsfrei sind.

Die Netzkabel müssen nach der Installation mithilfe von Kabelbindern oder ähnlichem Material ordnungsgemäß befestigt werden, um ein versehentliches Abziehen der Stecker zu verhindern.

Eingangsparameter der Geräte

Stromversorgung: +DC1, +DC2 & –COM

Betriebsspannungsbereich = 24 V to 48 VDC.

I/O-Anschluss: 'Status +' & 'Status –' und 'Digital in +' und 'Digital in –'

Maximale I/P-Spannung = 60 VDC.



Certification ATEX



Numéro de certification ATEX

Baseefa12ATEX0119X

Normes

EN 60079-0:2012, EN 60079-15:2010

Code de certification

Ex nA [op is T4] IIC T3 Gc ($-40^{\circ}\text{C} \leq T_a \leq +70^{\circ}\text{C}$)

Code ATEX

 II 3G

Conditions spéciales d'utilisation

L'équipement doit être installé dans une zone où le degré de pollution ne dépasse pas le degré 2 conformément à l'IEC/EN 60664-1, et dans un boîtier qui fournit un niveau de protection au moins égal à IP54 et conforme aux exigences applicables à EN 60079-0 et EN 60079-15

Toutes les connexions externes à l'équipement et, le cas échéant, les modules SFP ne doivent pas être insérés ou retirés sauf si la zone dans laquelle l'équipement est installé est reconnue comme non dangereuse, ou si les circuits raccordés sont hors-tension.

Une fois les câbles réseau installés, ils doivent être correctement fixé grâce à des attaches de câbles ou autre élément semblable afin de réduire le risque de débranchement accidentel.

Paramètres d'entrée des équipements

Connecteur d'alimentation : +DC1, +DC2 & –COM

Double entrée d'alimentation 24 V à 48 VCC

Connecteur E/S : « Statut + » et « Statut – » et « Entrée digitale + » et « Entrée digitale – »

Tension maximale I/P = 60 VCC.

Maintenance

No maintenance is required, as long as the unit is used as intended within the specified conditions.

Agency approvals and standards compliance

Type	Approval / Compliance
EMC	EN 61000-6-1, Immunity residential environments
	EN 61000-6-2, Immunity industrial environments
	EN 61000-6-3, Emission residential environments
	EN 61000-6-4, Emission industrial environments
	EN 55022 +A1, Emission IT equipment
	EN 55024 +A1 + A2, Immunity IT equipment
	FCC part 15 Class B
	EN 50121-4, Railway signalling and telecommunications apparatus
Safety	UL/IEC/EN 60950-1, IT equipment
Marine	DNV Standard for Certification no. 2.4
EX	EN 60079-0 and EN 60079-15

FCC Part 15.105

Notice:

This equipment has been tested and found to comply with the limits for a Class B digital device, pursuant to Part 15 of the FCC Rules. These limits are designed to provide reasonable protection against harmful interference in a residential installation. This equipment generates, uses and can radiate radio frequency energy and, if not installed and used in accordance with the instructions, may cause harmful interference to radio communications. However, there is no guarantee that interference will not occur in a particular installation. If this equipment does cause harmful interference to radio or television reception, which can be determined by turning the equipment off and on, the user is encouraged to try to correct the interference by one or more of the following measures:

- ⌘ Reorient or relocate the receiving antenna
- ⌘ Increase the separation between the equipment and receiver
- ⌘ Connect the equipment into an outlet on a circuit different from that to which the receiver is connected
- ⌘ Consult the dealer or an experienced radio/TV technician for help.

Corrosive environment

Notice:

This product has been successfully tested in a corrosion test according to IEC 60068-2-60, method 3. This means that the product meets the requirements to be placed in an environment classified as ISA-S71.04 class G3.

Note! If the product is placed in a corrosive environment, it is important that all un-used connector sockets are protected with a suitable plug in order to avoid corrosion attacks on the gold plated pins in connectors.

Declaration of Conformity



Westermo Teleindustri AB

Declaration of conformity

The manufacturer Westermo Teleindustri AB
SE-640 40 Stora Sundby, Sweden

Herewith declares that the product(s)

Type of product	Model ¹	
Industrial Ethernet 6-port Device Server Switch	Lynx DSS	L*06-S2-EX*

is in conformity with the following EC directive(s).

No	Short name
2004/108/EC	Electromagnetic Compatibility (EMC)
2011/65/EU	Restriction of the use of certain hazardous substances in electrical and electronic equipment (RoHS)

References of standards applied for this EC declaration of conformity.

No	Title	Issue
EN 61000-6-1	Electromagnetic compatibility – Immunity for residential environments	2007
EN 61000-6-2	Electromagnetic compatibility – Immunity for industrial environments	2005
EN 61000-6-3	Electromagnetic compatibility – Emission for residential environments	2007 +A1:2011
EN 61000-6-4	Electromagnetic compatibility – Emission for industrial environments	2007 +A1:2011
EN 55024	Information technology equipment - Immunity	1998 +A1:2001 +A2:2003
EN 55022	Information technology equipment - Emission	2006 +A1:2007
EN 50121-4	Railway applications - Electromagnetic compatibility Emission and immunity of the signalling and telecommunications apparatus	2006
EN 60079-0	Explosive atmospheres Equipment – General requirements	2012
EN 60079-15	Electrical apparatus for explosive gas atmospheres – Construction, test and marking of type of protection “n”	2010

The last two digits of the year in which the CE marking was affixed: 13

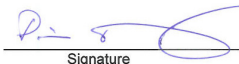
Signature

Pierre Öberg
Technical Manager
08th December 2013

¹ The first “*” in the model name can be any alphanumeric character, indicating software version. The second “*” in the model name can be any alphanumeric characters indicating customer specific models, or blank.

Postadress/Postal address	Tel.	Telefax	Postgiro	Bankgiro	Org.nr/ Corp. identity number	Registered office
S-640 40 Stora Sundby	016-428000	016-428001	52 72 79-4	5671-5550	556361-2604	Eskilstuna
Sweden	Int+46 16428000	Int+46 16428001				

Type tests and environmental conditions

Environmental phenomena	Basic standard	Description	Test levels
Electrostatic discharge	EN 61000-4-2	Enclosure	Contact: ± 6 kV Air: ± 8 kV
Fast transients	EN 61000-4-4	Power port	± 2 kV
		Ethernet	
		Status out/Digital in	
		Serial ports	
Surge	EN 61000-4-5	Enclosure	L-L: ± 0.5 kV, 2Ω , $18 \mu\text{F}$ L-E: ± 2 kV, 42Ω , $0.5 \mu\text{F}$ L-L: ± 1 kV, 42Ω , $0.5 \mu\text{F}$ L-E: ± 2 kV, 12Ω , $9 \mu\text{F}$ L-L: ± 1 kV, 12Ω , $9 \mu\text{F}$
		Power port	
		Ethernet	
		Status out/Digital in	
		RS-232	
Power frequency magnetic field	EN 61000-4-8	Enclosure	RS-422/485 L-E: ± 2 kV, 42Ω , $0.5 \mu\text{F}$
		Enclosure	300 A/m; 0, 16.7, 60 Hz 1000 A/m; 50 Hz
Pulsed magnetic field	EN 61000-4-9	Enclosure	300 A/m
Radiated RF immunity	EN 61000-4-3	Enclosure	20 V/m @ (80 – 2700) MHz 1 kHz sine, 80% AM
Conducted RF immunity	EN 61000-4-6	Power port	10 V, 80% AM, 1 kHz; (0.15 – 80) MHz
		Ethernet	
		Status out/Digital in	
		Serial ports	
		Earth port	
Radiated RF emission	EN 55022/ FCC Part 15/ DNV 2.4	Enclosure	Class B / DNV bridge
Conducted RF emission	EN 55022/ FCC Part 15/ DNV 2.4	Power port	Class B / DNV bridge
		Ethernet	Class B
Compass safe distance	DNV 2.4	Enclosure	Standard compass (5.4°/H deviation) = 15 cm Steering/standby steering/emergency compass (18°/H deviation) = 10 cm
Dielectric strength	EN 60950-1	Power port to all other ports	1.5 kVrms, 50 Hz, 1 min
		Ethernet ports to all other ports	
		RS-232 port to all other ports	
		RS-422/485 port to all other ports	

Environmental			
Temperatures		Operating	-40 to +70°C (-40 to +158°F)*
		Storage and transport	-50 to +85°C (-58 to +185°F)
Humidity		Operating	5 to 95 % relative humidity
		Storage and transport	5 to 95 % relative humidity
Altitude		Operating	2 000 m / 70 kPa
MTBF	MIL-C217F2, Parts count	Ground Benign, 25°C (77°F)	593 000 hours
Service life		Operating	10 year
Vibration	IEC 60068-2-6 (sine)	Operating	3 – 13.2 Hz: 1mm 13.2 – 100 Hz: 0.7 g 5.5 – 30 Hz: 1.5 g 30 – 50 Hz: 0.42 mm 50 – 500 Hz: 4.2 g**
	IEC 60068-2-64 (random)		5 – 20 Hz: 2 m ² /s ³ , 20 – 2000 Hz: – 3 dB/oct
Shock	IEC 60068-2-27	Operating	30 g, 11 ms 100 g, 6 ms**
Bump	IEC 60068-2-27	Operating	10 g, 11 ms
Packaging			
Enclosure	EN 60950-1	Zinc	Fire enclosure
Dimension W x H x D With connectors			52.5 x 100 x 101 mm 52.5 x 119 x 101 mm
Weight			0.7 kg
Degree of protection	EN 60529	Enclosure	IP 40
Cooling			Convection

* Refer to “Safety” section in User Guide.

** Might require Ethernet cables to be fastened close to the unit.

Description

L10-S2 EX / L206-S2 EX is an Industrial switch and device server made for harsh environments. WeOS is the operating system of L106-S2/L206-S2 enabling the unit to operate in two functional levels. The switch can be used in either 10 or 100 Mbit networks.

Lynx DSS L106-S2 EX / L206-S2 EX has two serial ports, one that supports RS-232 and the other configurable for RS-232/422/485 as well as serial protocols for interconnection with legacy equipment.

Our unique FRNT (Fast Recovery of Network Topology) technology is the fastest protocol on the market to re-configure a network in the event of any link or hardware failure. That is why our equipment are used in safety critical applications such as tunnels, traffic signal control and railway systems.

Interface specifications

Power	
Operating voltage	Rated: 24 to 48 VDC Operating: 19 to 60 VDC
Rated current	150 mA (300 mA) @ 24VDC (with 500 mA USB load) 80 mA (150 mA) @ 48VDC (with 500 mA USB load)
Rated frequency	DC
Inrush current, I ² t	22.7·10 ⁻³ A ² s @ 48 VDC
Startup current*	2 x Rated current
Polarity	Reverse polarity protected
Redundant power input	Yes
Isolation to	All other
Connection	Detachable screw terminal
Connector size	0.2 – 2.5 mm ² (AWG 24 – 12)
Shielded cable	Not required

* External supply current capability for proper start-up

Ethernet TX	
Electrical specification	IEEE std 802.3. 2005 Edition
Data rate	10 Mbit/s, 100 Mbit/s, manual or auto
Duplex	Full or half, manual or auto
Circuit type	TNV-1
Transmission range	Up to 150 m with CAT5e cable or better*
Isolation to	All other
Connection	RJ-45, auto MDI/MDI-X
Cabling	Shielded CAT5e or better is recommended
Conductive housing	Yes
Number of ports	4

* Refer to Safety section.

RS-232	
Electrical specification	EIA RS-232
Data rate	50 bit/s – 115.2 kbit/s
Data format	7 or 8 data bits, Odd, even or none parity, 1 or 2 stop bits
Protocol	Transparent, optimised by packing algorithm
Circuit type	SELV
Transmission range	15 m / 49 ft
Isolation to	All other
Connection	RJ-45 according to EIA-561
Shielded cable	Recommended
Conductive housing	Yes
Number of ports	1

RS-232/422/485		
Electrical specification		Configurable for EIA RS-232 or EIA RS-422/485
Data rate	RS-232	50 bit/s – 115.2 kbit/s
	RS-422/485	50 bit/s – 2 Mbit/s
Data format		7 or 8 data bits, Odd, even or none parity, 1 or 2 stop bits (2 stop bits only when no parity is set)
Circuit type		TNV-1
Transmission range	RS-232	15 m / 49 ft
	RS-422/485	Up to 1200 m / 0.74 mi, depending on data rate and cable type
Isolation to		All other
Connection	RS-232	RJ-45 according to EIA-561
	RS-422/485	RJ-45
Shielded cable	RS-232	Recommended
	RS-422/485	Not required, but recommended in railway installations close to the rails.*
Conductive housing		Yes
Number of ports		1

* To minimise the risk of interference, a shielded cable is recommended when the cable is located inside 3 m boundary or the cable is longer than 30 m and inside 10 m boundary to the rails and connected to this port.

I/O / Relay output	
Maximum voltage/current	60 VDC / 80 mA
Contact resistance	Max 30 Ω
Isolation to	All other
Connection	Detachable screw terminal
Connector size	0.2 – 2.5 mm ² (AWG 24 – 12)

I/O / Digital input	
Maximum voltage/load current	60 VDC / 2 mA
Voltage levels	Logic one: >12V Logic zero: <1V
Isolation to	All other
Connection	Detachable screw terminal
Connector size	0.2 – 2.5 mm ² (AWG 24 – 12)

USB	
Electrical specification	USB 2.0 host interface
Data rate	Up to 12 Mbit/s (full-speed mode)
Circuit type	SELV
Maximum supply current	500 mA
Connection	USB receptacle connector type A

Console	
Electrical specification	LVTTTL/LVCMOS-level
Data rate	115.2 kbit/s
Data format	8 data bits, no parity, 1 stop bit, no flow control
Circuit type	SELV
Connection	2.5 mm jack, use only Westermo cable 1211-2027

Safety control drawing

Location of interface ports and LED's

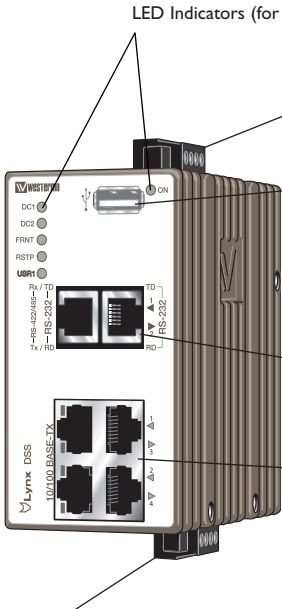

LED Indicators (for details see page 16)

Power connection (for details see page 9)

USB

Position	Direction* / description	Output values
1	Out / VBUS	$U_{out} = 5\text{VDC max}$ $I_{out} = 500\text{ mA max}$
2	In/out / D-	
3	In/out / D+	
4	GND	
Shield	PE	

RS-232, RS-422/485 (for details see page 9, 10 and 13)

Ethernet connection TX (4 ports)

Position	Signal	Direction	Description	Input/output values
No.1	TD+	In/Out	Transmitted/Received data	Per port: $U = \pm 1\text{V}$ (4 $\mu\text{V/s}$) $I = \pm 20\text{ mA}$ Data rate: 10/100 Mbit/s
No. 2	TD-	In/Out	Transmitted/Received data	
No. 3	RD+	In/Out	Transmitted/Received data	
No. 4	-	-	Not Connected	
No. 5	-	-	Not Connected	
No. 6	RD-	In/Out	Transmitted/Received data	
No. 7	-	-	Not Connected	
No. 8	-	-	Not Connected	
Shield			Connected to PE	

Galvanically isolated via signal transformers and capacitively isolated to GND/PE through a 2kV 1000pF capacitor.
See user manual for proven transient protection.

I/O connection
(for details see page 10 and 15)

RJ-45 connector (Front view)

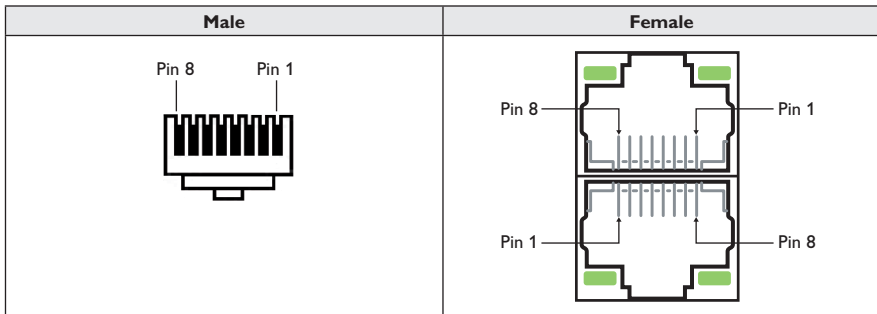

RS-422/485 (for more details see below)

Position	Signal		Direction	Description	Input/Output values
	RS-422 (4-wire)	RS-485 (2-wire)			
No. 1	T+	T+/R+	Out/In	RS-422: Transmit RS-485: Transmit/Receive	U = 5 V max I = 250 mA max Data rate: 50 bit/s – 2 Mbit/s
No. 2	T-	T-/R-	Out/In	RS-422: Transmit RS-485: Transmit/Receive	
No. 3	R-	-	In	RS-422: Receive	
No. 4	-	-	-	Not used	
No. 5	-	-	-	Not used	
No. 6	R+	-	In	RS-422: Receive	
No. 7	-	-	-	Not used	
No. 8	-	-	-	Not used	

RS-232

Position	Signal	Direction	Description	Input/Output values
No. 1	DSR	Out	Data Set Ready	U = ±12 V max I = ±60 mA max Data rate: 50 bit/s – 115.2 kbit/s
No. 2	DCD	Out	Data Carrier Detect	
No. 3	DTR	In	Data Terminal Ready	
No. 4	SG	-	Signal Ground, not chassis ground	
No. 5	RD	Out	Receive Data	
No. 6	TD	In	Transmit Data	
No. 7	CTS	Out	Clear To Send	
No. 8	RTS	In	Request To Send	

Lynx DSS is equipped with internal termination that is configurable through software in RS-422/485 mode. The following termination schemes are supported:

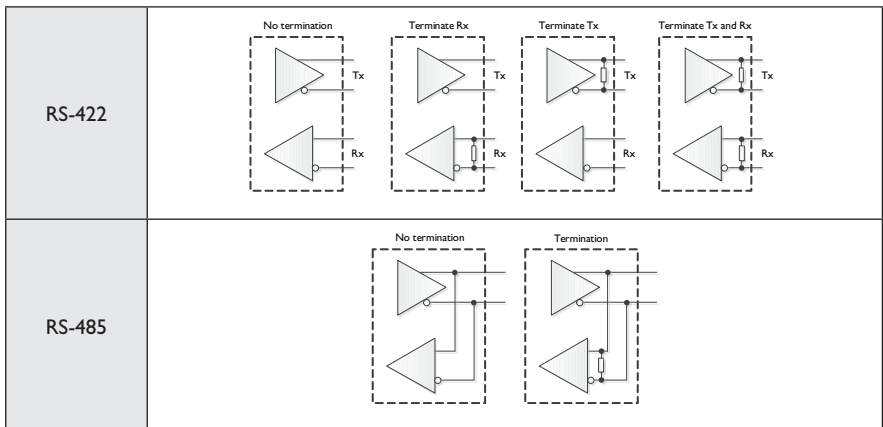

When the unit is powered-off or during reboot, any internal termination will be disconnected from the signal lines.

Note: Due to that the port is configurable for both RS-232 and RS-422/485, there are no fail-safe biasing available for RS-422/485 signals.

Safety control drawing

I/O connection (for details see page 15)

Console port
(for details see page 15)

Cable 1211-2027

Bottom view

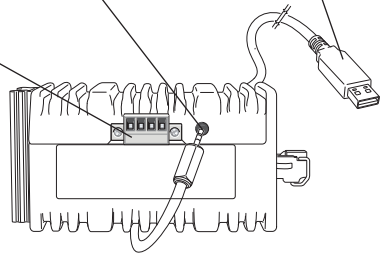

Connection to console port

The console port can be used to connect to the CLI (Command Line Interface).

The following steps needs to be taken

1. Connect the serial diagnostic cable to the console port (use only Westermo cable 1211-2027).
2. Connect cable to your computer (USB port, if drivers are needed they can be downloaded from our Web page).
3. Use a terminal emulator and connect with correct speed and format (115200, 8N1) to the assigned port.

For more information about the CLI, see the WeOS management guide.

Accessories	
Description	Art no
Westermo console cable	1211-2027
RJ45 to terminal block	1200-2490
RJ45 to DB9 cable	1211-2210

Safety control drawing

Power connection

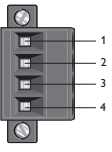
	4-position	Product marking	Direction	Description	Input values
	No. 1	+DC1	Input	Supply voltage input DC1	$U_{in} = (19 - 60) \text{VDC}$ $I_{in} = 300 \text{ mA @ } 24 \text{VDC}$ $P_{in} = 7.2 \text{ W @ } 24 \text{VDC}$
	No. 2	+DC2	Input	Supply voltage input DC2	
	No. 3	-COM	Input	Common	
	No. 4	-COM	Input	Common	

Lynx supports redundant power connection. The positive inputs are +DC1 and +DC2, the negative input for both supplies are -COM. Connect the primary voltage (e.g. +24VDC) to the +DC1 pin and return to one of the -COM pins on the power input.

I/O connection

	4-position	Product marking	Direction	Description	Input / Output values
	No. 1	Status +	Output	Alarm relay (status) contact	$U_{in} = 60 \text{ VDC max}$
	No. 2	Status -	Output	Alarm relay (status) contact	$I_{in} = 80 \text{ mA max}$
	No. 3	Digital in +	Input	Digital in +	$U_{in} = 60 \text{ VDC max}$
	No. 4	Digital in -	Input	Digital in -	$I_{in} = 2 \text{ mA max}$

The Status output is a potential free, opto-isolated normally closed solid-state relay. This can be configured to monitor various alarm events within the Lynx unit, see VWeOS Management Guide. An external load in series with an external voltage source is required for proper functionality. For voltage/current ratings, see Interface Specification section.

Console port

Position	Direction* / description	Input/output values
No.1	In / out / GND	$U = 3.3 \text{ VDC max}$ $I = 24 \text{ mA max}$
No. 2	Out / Tx	
No. 3	In / Rx	

* Direction relative to this unit.

The Digital in is an opto-isolated digital input which can be used to monitor external events. For voltage/current ratings, see Interface Specification section:

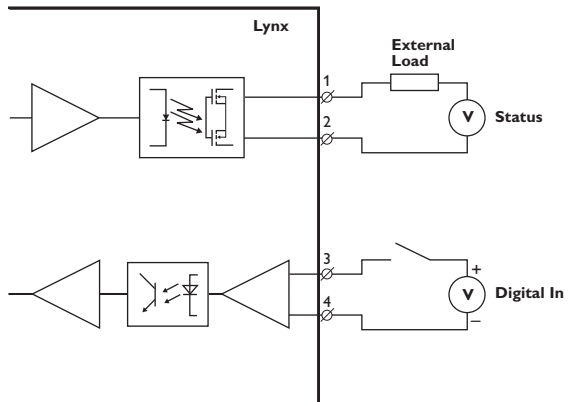

LED indicators

LED	Status	Description
ON	OFF	Unit has no power.
	GREEN	All OK, no alarm condition.
	RED	Alarm condition, or until unit has started up. (Alarm conditions are configurable, see "WeOS Management Guide").
	BLINK	Location indicator ("Here I am!"). Activated when connected to IPConfig Tool, or upon request from Web or CLI.
DC1	OFF	Unit has no power.
	GREEN	Power OK on DC1.
	RED	Power failure on +DC1.
DC2	OFF	Unit has no power.
	GREEN	Power OK on DC2.
	RED	Power failure on +DC2.
FRNT	OFF	FRNT disabled.
	GREEN	FRNT OK.
	RED	FRNT Error.
	BLINK	Unit configured as FRNT Focal Point.
RSTP	OFF	RSTP disabled.
	GREEN	RSTP enabled.
	BLINK	Unit elected as RSTP/STP root switch.
USR1	OFF	Configurable, see WeOS Management Guide.
	GREEN	
	RED	
Rx/TD, TD	OFF	No serial data received.
	GREEN FLASH	Serial data received.
Tx/RD, RD	OFF	No serial data transmitted.
	GREEN FLASH	Serial data transmitted.
1 to 4	OFF	No Link.
	GREEN	Link established.
	GREEN FLASH	Data traffic indication.
	YELLOW	Port alarm and no link. Or if FRNT or RSTP mode, port is blocked.

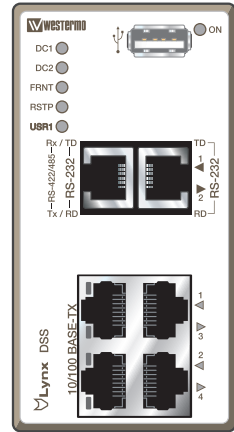

Mounting

This unit should be mounted on 35 mm DIN-rail, which is horizontally mounted inside an apparatus cabinet or similar. It is recommended that the DIN-rail is connected to ground. Snap on mounting, see figure.

Mounting Lynx with integrated DIN-clip:

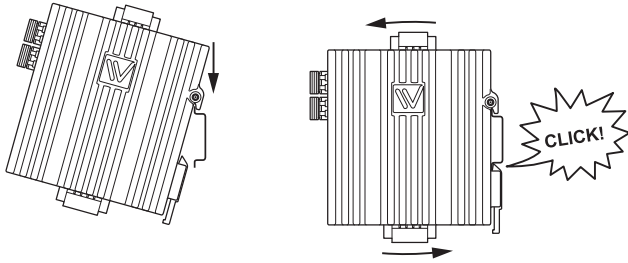

Removal

Removing Lynx with integrated DIN-clip:

Press down the support at the back of the unit using a screwdriver. See figure.

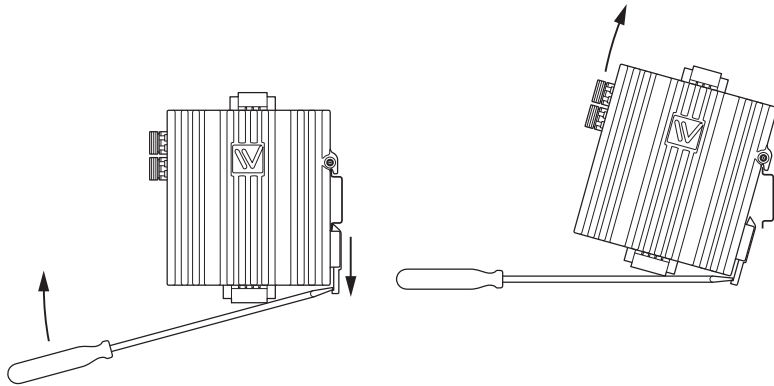

Cooling

This unit uses convection cooling. To avoid obstructing the airflow around the unit, use the following spacing rules. Minimum spacing 25 mm (1.0 inch) above / below and 10 mm (0.4 inches) left / right the unit. Spacing is recommended for the use of unit in full operating temperature range and service life.

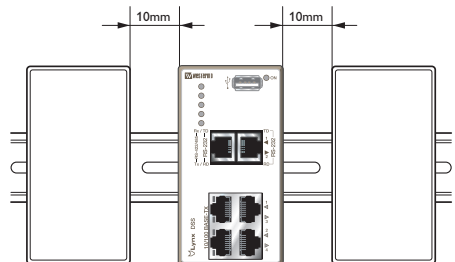

Getting Started

This product runs Westermo Operating System (WeOS) which provides several management tools that can be used for configuration of the unit.

- **IPConfig tool**

This is a custom Westermo tool used for discovery of attached Westermo units.
Note! Version of IP Config tool must be 10.4.0 or higher.

- **Web**

Configuration of the unit using the web browser.

- **CLI**

Configuration of the unit via the Command Line Interface.

Username: admin

Password: westermo

If the computer is located in the same subnet as the switch you can easily use a web browser to configure the unit. Within the web you can configure most of the available functions.

For advanced network settings and more diagnostic information, please use the CLI. Detailed documentation is available in the chapter "The Command Line Management Tool" in the WeOS management guide.

Factory default *IP address:* 192.168.2.200
 Netmask: 255.255.255.0
 Gateway: Disabled

Note! If you are not sure about the subnet – consult your network administrator.

Configuration

Configure the unit via Web browser

The unit can easily be configured via a Web browser.

Open the link <http://192.168.2.200> in your web browser, and you will be prompted with a Login screen, where the default settings for Username and Password are:

Username: admin

Password: westermo

Once you have logged in, you can use the extensive integrated help function describing all configuration options. Two common task when configuring a new switch is to assign appropriate IP settings, and to change the password of the admin account.

The password can be up to 64 characters long, and should consist of printable ASCII characters (ASCII 33-126); 'Space' is not a valid password character.

Referring documents

Type	Description	Document number
Management Guide	Westermo OS management guide	6101-3201

Factory default on L106-S2 EX / L206-S2 EX

It is possible to set the unit to factory default settings by using two straight standard Ethernet RJ-45 cables.

1. Power off the switch and disconnect all Ethernet cables (copper and fibre).
 2. Connect one Ethernet cable between Ethernet ports 1 and 4, and the other between Ethernet ports 2 and 3.
The ports need to be connected directly by an Ethernet cable, i.e., not via a hub or switch. Use a straight cable – not a cross-over cable – when connecting the ports.
 3. Power on the unit.
 4. Wait for the unit to start up. Control that the ON LED is flashing red.
The ON LED flashing indicates that the unit is now ready to be reset to factory default. You now have the choice to go ahead with the factory reset, or to skip factory reset and boot as normal.
 - Go ahead with factory reset:
Acknowledge that you wish to conduct the factory reset by unplugging the Ethernet cables. The ON LED will stop flashing.
This initiates the factory reset process*, and the unit will restart with factory default settings. When the switch has booted up, the ON LED will show a green light, and is now ready to use.
 - Skip the factory reset:
To skip the factory reset process, just wait for approximately 30 seconds (after the ON LED starts flashing RED) without unplugging the Ethernet cables.
The switch will conduct a normal boot with the existing settings.
- * **Note** Do not power off the unit while the factory reset process is in progress.

Dimensions

Measurements are stated in millimeters.

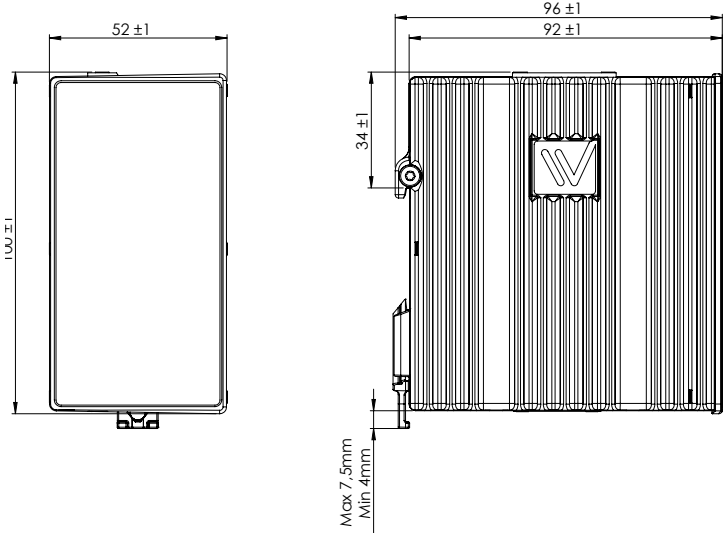



Westermo • SE-640 40 Stora Sundby, Sweden
Tel +46 16 42 80 00 Fax +46 16 42 80 01
E-mail: info@westermo.com
www.westermo.com

Sales Units

Westermo Data Communications

China

sales.cn@westermo.com
www.cn.westermo.com

France

infos@westermo.fr
www.westermo.fr

Germany

info@westermo.de
www.westermo.de

North America

info@westermo.com
www.westermo.com

Singapore

sales@westermo.com.sg
www.westermo.com

Sweden

info.sverige@westermo.se
www.westermo.se

United Kingdom

sales@westermo.co.uk
www.westermo.co.uk

Other Offices



For complete contact information, please visit our website at www.westermo.com/contact or scan the QR code