



TGS-9120-M12

Industrial Managed Ethernet Switch

User Manual

Version 1.0

September, 2014

www.oring-networking.com

COPYRIGHT NOTICE

Copyright © 2014 ORing Industrial Networking Corp.

All rights reserved.

No part of this publication may be reproduced in any form without the prior written consent of ORing Industrial Networking Corp.

TRADEMARKS

ORing is a registered trademark of ORing Industrial Networking Corp.

All other trademarks belong to their respective owners.

REGULATORY COMPLIANCE STATEMENT

Product(s) associated with this publication complies/comply with all applicable regulations.

Please refer to the Technical Specifications section for more details.

WARRANTY

ORing warrants that all ORing products are free from defects in material and workmanship for a specified warranty period from the invoice date (5 years for most products). ORing will repair or replace products found by ORing to be defective within this warranty period, with shipment expenses apportioned by ORing and the distributor. This warranty does not cover product modifications or repairs done by persons other than ORing-approved personnel, and this warranty does not apply to ORing products that are misused, abused, improperly installed, or damaged by accidents.

Please refer to the Technical Specifications section for the actual warranty period(s) of the product(s) associated with this publication.

DISCLAIMER

Information in this publication is intended to be accurate. ORing shall not be responsible for its use or infringements on third-parties as a result of its use. There may occasionally be unintentional errors on this publication. ORing reserves the right to revise the contents of this publication without notice.

CONTACT INFORMATION

ORing Industrial Networking Corp.

3F., NO.542-2, Jhongjheng Rd., Sindian District, New Taipei City 231, Taiwan, R.O.C.

Tel: + 886 2 2218 1066 // Fax: + 886 2 2218 1014

Website: www.oring-networking.com

Technical Support

E-mail: support@oring-networking.com

Sales Contact

E-mail: sales@oring-networking.com (Headquarters)

sales@oring-networking.com.cn (China)

Table of Content

Getting Started	6
1.1 About the TGS-9120-M12	6
1.2 Software Features	6
1.3 Hardware Specifications.....	7
Hardware Overview.....	8
2.1 Front Panel.....	8
2.2 Front Panel LED	9
2.3 Bypass Technology (TGS-9120-M12-BP2 Only).....	9
Hardware Installation.....	11
3.1 Wall-mount Installation	11
3.2 Wiring.....	12
3.2.1 Grounding.....	13
3.2.2 Fault Relay	13
3.2.3 Redundant Power Inputs.....	13
3.3 Connection	13
3.3.1 Cables.....	13
10/100/1000BASE-T(X) Pin Assignments	13
Console port wiring	15
3.3.2 O-Ring/O-Chain	15
O-Ring	15
Redundancy	19
4.1 O-Ring	19
4.1.1 Introduction.....	19
4.1.2 Configurations.....	19
4.2 OPEN-Ring.....	21
4.2.1 Introduction.....	21
4.2.2 Configurations.....	21
4.3 O-Chain	22
4.3.1 Introduction.....	22
4.3.2 Configurations.....	22
4.4 Bypass (TGS-9120-M12-BP2 Only).....	23
4.4.1 Introduction.....	23
4.4.2 Bypass & Ring Topology	24

4.5	MRP.....	26
4.5.1	Introduction.....	26
4.5.2	Configurations.....	26
4.6	STP/RSTP/MSTP	27
4.6.1	STP/RSTP.....	27
	STP Bridge Status.....	27
	STP Bridge Configurations	29
4.6.2	MSTP.....	30
	Port Settings	30
	Mapping	31
	Priority	33
4.6.3	CIST.....	33
4.7	Fast Recovery.....	35
Management		37
5.1	Basic Settings.....	38
5.1.1	System Information.....	38
5.1.2	Admin & Password	39
5.1.3	Authentication Methods	40
5.1.4	IP Settings.....	40
5.1.5	IPv6 Settings	41
5.1.6	Daylight Saving Time.....	43
5.1.7	HTTPS	45
5.1.8	SSH	45
5.1.9	LLDP	46
5.1.10	NTP	49
5.1.11	Modbus TCP	50
5.1.12	Backup/Restore Configurations	50
5.1.13	Firmware Update.....	51
5.2	DHCP Server.....	51
5.2.1	Basic Settings	51
5.2.2	Dynamic Client List.....	52
5.2.3	Client List	52
5.2.4	Relay Agent.....	53
5.3	Port Setting	55
5.3.1	Port Control.....	55
5.3.2	Port Trunk	56
5.3.4	Loop Gourd.....	61

5.4	VLAN	63
5.4.1	VLAN Membership	63
5.4.2	Port Configurations.....	64
	Introduction of Port Types	66
	Examples of VLAN Settings	69
5.4.3	Private VLAN.....	73
5.5	SNMP.....	74
5.5.1	SNMP System Configurations.....	75
5.5.2	SNMP Community Configurations.....	77
5.5.3	SNMP User Configurations.....	78
5.5.4	SNMP Group Configurations	79
5.5.5	SNMP View Configurations.....	80
5.5.6	SNMP Access Configurations	81
5.6	Traffic Prioritization	82
5.6.1	Storm Control	82
5.6.2	Port Classification.....	83
5.6.3	Port Tag Remaking	85
5.6.4	Port DSCP	85
5.6.5	Policing	87
	Queue Policing	88
5.6.7	Scheduling and Shaping.....	88
5.6.8	Port Scheduler	91
5.6.9	Port Shaping	92
5.6.10	DSCP-based QoS	92
5.6.11	DSCP Translation.....	93
5.6.12	DSCP Classification	94
5.6.13	QoS Control List.....	94
	Label	95
	Description.....	95
5.6.14	QoS Counters	97
5.6.15	QCL Status.....	97
5.7	Multicast.....	98
5.7.1	IGMP Snooping.....	98
5.7.2	VLAN Configurations of IGMP Snooping.....	99
5.7.3	IGMP Snooping Status	101
5.7.4	Groups Information of IGMP Snooping	101
5.8	Security	102

5.8.1	Remote Control Security Configurations	102
5.8.2	Device Binding	103
5.8.3	ACL.....	108
5.8.4	Authentication, Authorization, and Accounting.....	120
	Authentication and Accounting Server Status	123
	Authentication and Accounting Server Statistics	124
5.8.6	NAS (802.1x).....	127
5.9	Alerts.....	137
5.9.1	Fault Alarm.....	137
5.9.2	System Warning	138
5.10	Monitor and Diag	141
5.10.1	MAC Table	141
5.10.2	Port Statistics	144
5.10.3	Port Mirroring	146
5.10.4	System Log Information.....	147
5.10.5	Cable Diagnostics	148
5.10.6	SFP Monitor.....	149
5.10.7	Ping	150
	IPv6 Ping.....	151
5.11	Synchronization.....	151
5.12	Troubleshooting.....	153
5.12.1	Factory Defaults	153
5.12.2	System Reboot.....	154
	Command Line Management	155

Getting Started

1.1 About the TGS-9120-M12

The TGS-9120-M12 series is a managed Gigabit Ethernet switch with 12x10/100/1000Base-T(X) ports. The series consists of BP2 models (TGS-9120-M12-BP2) and non-BP2 models (TGS-9120-M12). The BP2 models provide bypass functions to ensure constant network connectivity if power outage or node failure occurs. In such situations, the device will bypass the inactive switch and continue to transfer network traffic to the next switch in the relay. The series supports various Ethernet redundancy protocols such as O-Ring (recovery time < 30ms over 250 units of connection), Open-Ring, O-Chain, MRP and MSTP (RSTP/STP compatible) to protect your mission-critical applications from network interruptions or temporary malfunctions. With EN50155 compliance and M12 connectors, the series is a perfect choice for tough industrial environments as the features can ensure tight, robust connections, and guarantee reliable operation against environmental disturbances, such as vibration and shock. Supporting wide operating temperature from -40 to 75 degrees, the device can be managed centrally via Open-Vision, the Web-based interface, Telnet and console (CLI) configuration.

1.2 Software Features

- Supports Open-Ring interoperates with other vendors' ring technology in open architecture
- Supports O-Ring (recovery time < 30ms over 250 units of connection) and MSTP(RSTP/STP compatible) for Ethernet Redundancy
- Supports O-Chain that allows the device to operate in multiple redundant ring topologies
- Supports standard IEC 62439-2 MRP (Media Redundancy Protocol)
- Supports IEEE 1588v2 clock synchronization
- Supports IPv6 new Internet protocol version
- Supports Modbus TCP protocol
- HTTPS/SSH protocols for higher network security
- Supports IEEE 802.3az Energy-Efficient Ethernet technology
- Supports SMTP client
- Supports IP-based bandwidth management
- Supports application-based QoS management
- Supports Device Binding security
- Supports DOS/DDOS auto prevention
- IGMP v2/v3 (IGMP snooping support) for filtering multicast traffic

- Supports SNMP v1/v2c/v3 & RMON & 802.1Q VLAN network management
- Supports ACL, TACACS+ and 802.1x user authentication
- Supports 9.6K bytes Jumbo frame
- Multiple notifications during unexpected events
- Configuration via Web-based ,Telnet, Console (CLI), and Windows utility (Open-Vision)
- Supports LLDP Protocol

1.3 Hardware Specifications

- 2 12x10/100/1000Base-T(X) ports
- 3 1 x console port
- 4 2 sets of bypass ports (TGS-9120-M12-BP2)
- 5 EN50155-compliance
- 6 Redundant DC power inputs
- 7 Operating temperature: -40 to 75°C
- 8 Storage temperature: -40 to 85°C
- 9 Operating humidity: 5% to 95%, non-condensing
- 10 Casing: IP-30
- 11 Dimensions: 260 (W) x 91.3 (D) x216 (H) mm

Hardware Overview

2.1 Front Panel

The device provides the following ports on the front panel. All connectors are in M12 type to ensure tight, robust connections, as well as reliable operation against environmental disturbances, such as vibration and shock.

Port	Description
Power connector	1 x power connector
Ethernet ports	12 x 10/100/1000Base-T(X) M12 ports
Console	1 x console port
Relay output	1 x relay output
Reset button	1 x reset button

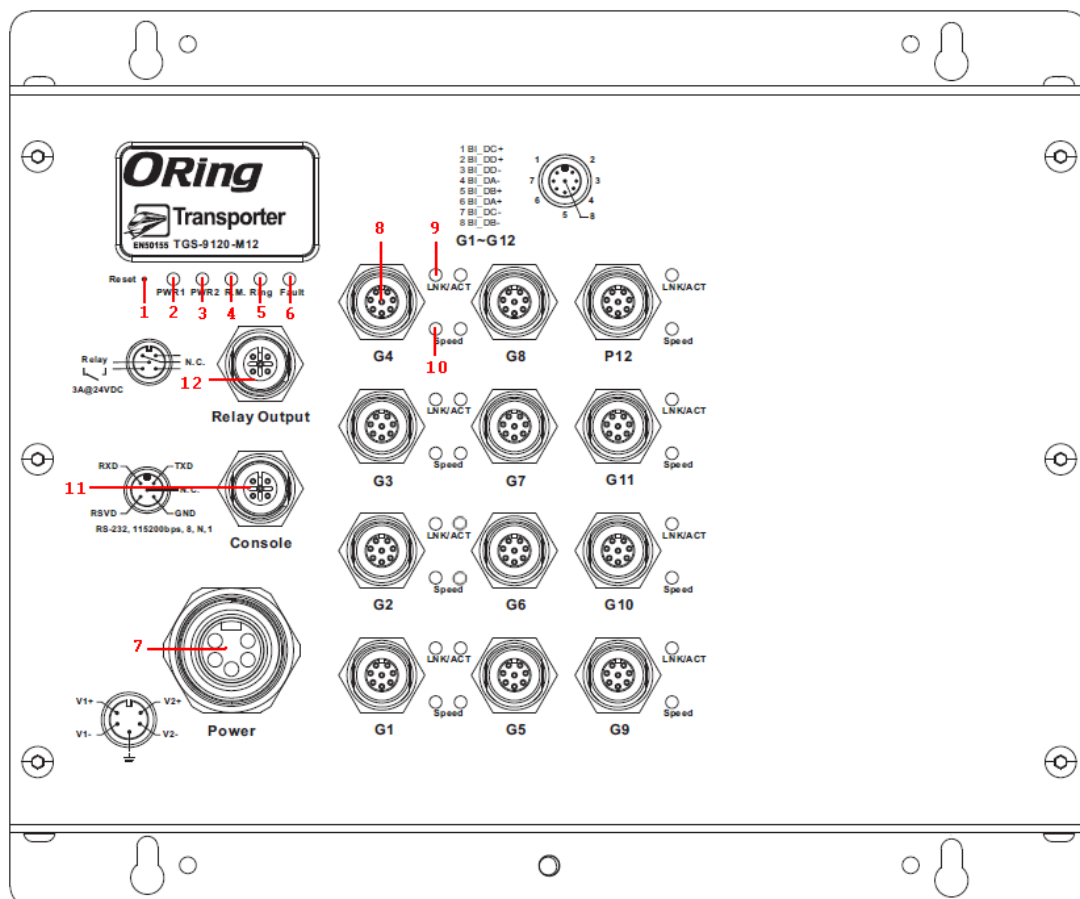

1. Reset button
2. Power 1 LED
3. Power 2 LED
4. R.M status LED
5. Ring status LED
6. Fault LED
7. Power connector
8. Gigabit Ethernet ports (G1 – G4 of BP2 model are bypass ports)
9. Link/ACT LED for Gigabit ports
10. Speed LED for Gigabit ports
11. Console port
12. Relay output

2.2 Front Panel LED

LED	Color	Status	Description
PW1	Green	On	DC power module 1 activated
PW2	Green	On	DC power module 2 activated
R.M	Green	On	Device operating in Ring Master mode
Ring	Green	On	Ring enabled
		Blinking	Ring structure is broken
Fault	Amber	On	Errors occur (i.e. power failure or port malfunctioning)
10/100/1000Base-T(X) Ethernet ports			
LNK/ACT	Green	On	Port is linked
		Blinking	Transmitting data
Speed	Green	On	Port is running at 1000Mbps
	Amber	On	Port is running at 100Mbps
	Green/Amber	Off	Port is running at 10Mbps

2.3 Bypass Technology (TGS-9120-M12-BP2 Only)

When a device connected to other devices through a switch without bypass function, the device will lose connection if the switch loses power as traffic will not be able to flow through the link (as shown in the figure below).

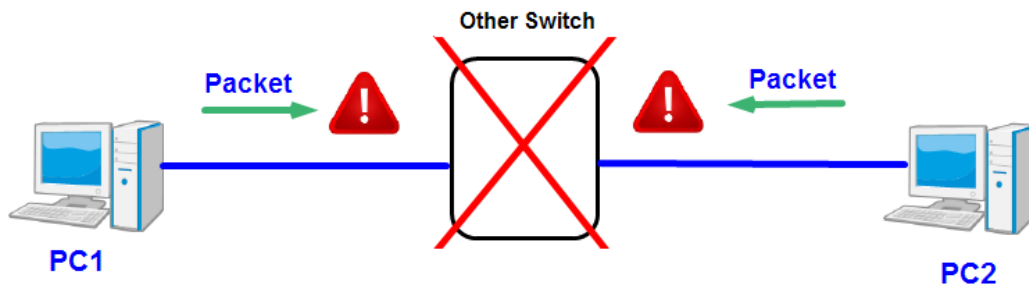

Switches with bypass functions such as the TGS-9120-M12-BP2 provide one or more sets of bypass ports that ensure constant network connectivity during power failure.

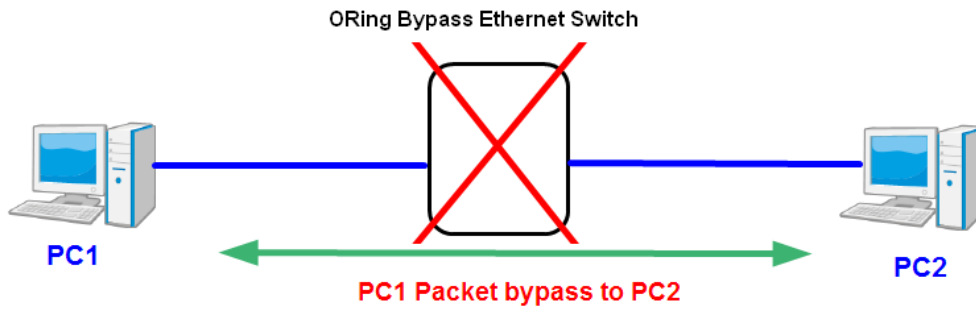

Hardware Installation

3.1 Wall-mount Installation

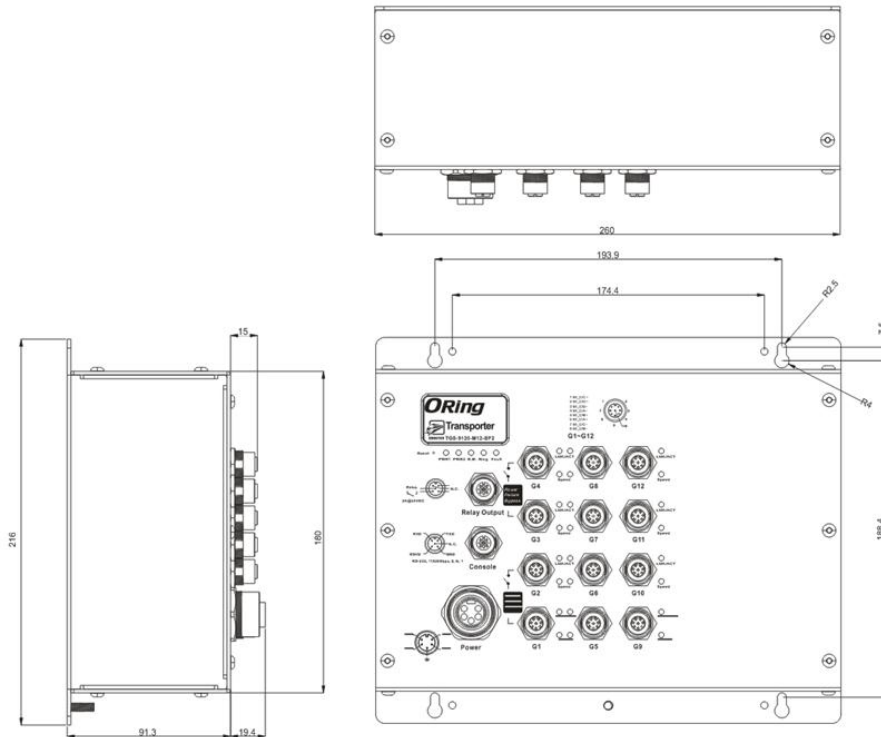

Wall-mount Measurement (Unit = mm)

Follow the steps below to mount the switch to the wall.

Step 1: Hold the switch upright against the wall

Step 2: Insert two screws through the screw holes located at the top and bottom of the unit and fasten the screw to the wall with a screwdriver.

Step 3: Slide the switch downwards and tighten the screws for added stability.

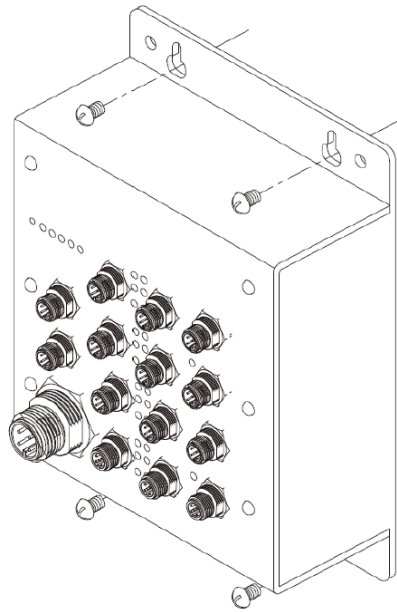

Instead of screwing the screws in all the way, it is advised to leave a space of about 2mm to allow room for sliding the switch between the wall and the screws.

3.2 Wiring



WARNING

Do not disconnect modules or wires unless power has been switched off or the area is known to be non-hazardous. The devices may only be connected to the supply voltage shown on the type plate.



ATTENTION

1. Be sure to disconnect the power cord before installing and/or wiring your switches.
2. Calculate the maximum possible current in each power wire and common wire. Observe all electrical codes dictating the maximum current allowable for each wire size.
3. If the current goes above the maximum ratings, the wiring could overheat, causing serious damage to your equipment.
4. Use separate paths to route wiring for power and devices. If power wiring and device wiring paths must cross, make sure the wires are perpendicular at the intersection point.
5. Do not run signal or communications wiring and power wiring through the same wire conduit. To avoid interference, wires with different signal characteristics should be routed separately.
6. You can use the type of signal transmitted through a wire to determine which wires should be kept separate. The rule of thumb is that wiring sharing similar electrical characteristics can be bundled together.
7. You should separate input wiring from output wiring.
8. It is advised to label the wiring to all devices in the system.

3.2.1 Grounding

Grounding and wire routing help limit the effects of noise due to electromagnetic interference (EMI). Run the ground connection on the power connector to the grounding surface prior to connecting devices.

3.2.2 Fault Relay

The switch uses the M12 A-coded 5-pin male connector on the front panel for relay output. Use a power cord with an M12 A-coded 5-pin female connector to connect the relay contacts from the switch. The relay contacts will detect user-configured events and form an open circuit when an event is triggered.

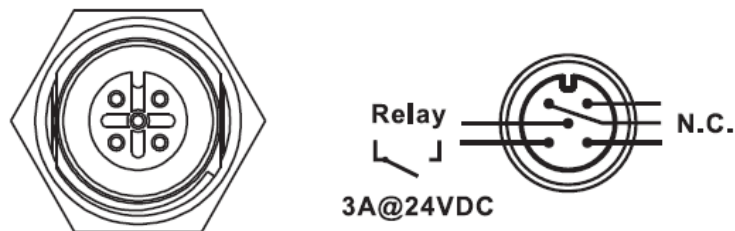

3.2.3 Redundant Power Inputs

The switch provides two sets of power supply on a M23 5-pin connector to enable dual power inputs.

Step 1: Insert a power cable to the power connector on the device.

Step 2: Rotate the outer ring of the cable connector until a snug fit is achieved. Make sure the connection is tight.

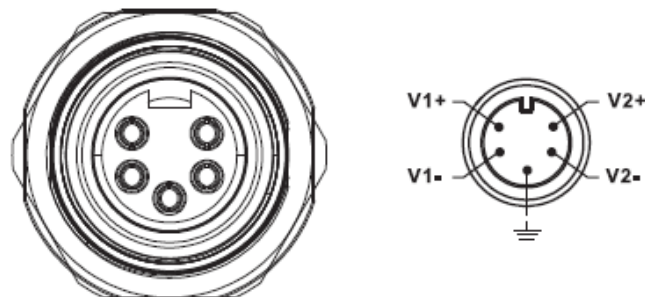

3.3 Connection

3.3.1 Cables

10/100/1000BASE-T(X) Pin Assignments

The device provides Ethernet ports in M12 connector type. According to the link type, the

switch uses CAT 3, 4, 5,5e UTP cables to connect to any other network devices (PCs, servers, switches, routers, or hubs). Please refer to the following table for cable specifications.

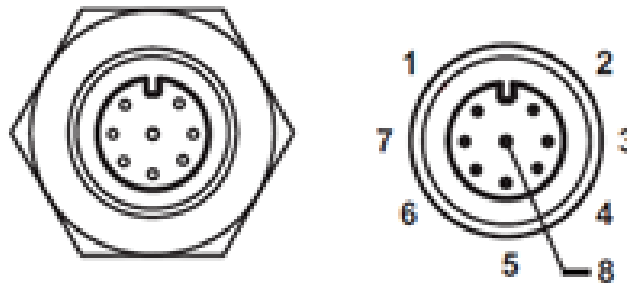

Cable Types and Specifications:

Cable	Type	Max. Length	Connector
10BASE-T	Cat. 3, 4, 5 100-ohm	UTP 100 m (328 ft)	M12 A-coding connector
100BASE-TX	Cat. 5 100-ohm UTP	UTP 100 m (328 ft)	M12 A-coding connector
1000BASE-TX	Cat. 5/Cat. 5e 100-ohm UTP	UTP 100 m (328ft)	M12 A-coding connector

Below is the pin assignment for the Ethernet ports.

10/100/1000Base-T(X) M12 port

Pin Number	Assignment
#1	BI_DC+
#2	BI_DD+
#3	BI_DD-
#4	BI_DA-
#5	BI_DB+
#6	BI_DA+
#7	BI_DC-
#8	BI_DB-

The device supports auto MDI/MDI-X operation. You can use a cable to connect the switch to a PC. The table below shows the 10/100Base-T(X) MDI and MDI-X port pin outs.

10/100 Base-T(X) MDI/MDI-X Pin Assignments:

Pin Number	MDI port	MDI-X port
1	TD+(transmit)	RD+(receive)
2	TD-(transmit)	RD-(receive)
3	RD+(receive)	TD+(transmit)
4	Not used	Not used
5	Not used	Not used
6	RD-(receive)	TD-(transmit)
7	Not used	Not used
8	Not used	Not used

1000Base-T MDI/MDI-X Pin Assignments:

Pin Number	MDI port	MDI-X port
1	BI_DA+	BI_DB+
2	BI_DA-	BI_DB-
3	BI_DB+	BI_DA+
4	BI_DC+	BI_DD+
5	BI_DC-	BI_DD-
6	BI_DB-	BI_DA-
7	BI_DD+	BI_DC+
8	BI_DD-	BI_DC-

Note: "+" and "-" signs represent the polarity of the wires that make up each wire pair.

Console port wiring

The switch has one RS-232 (M12 5-pin) console port, located on the front panel. Use a M12-to-DB9 console cable to connect the console port to your PC's COM port.

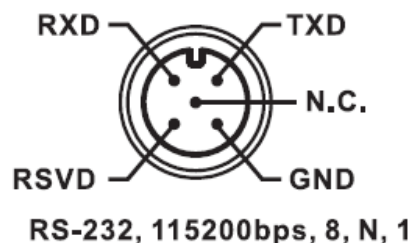
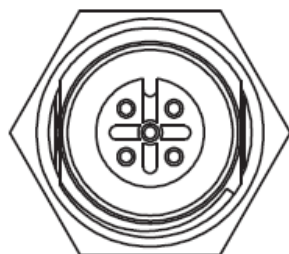

3.3.2 O-Ring/O-Chain

O-Ring

You can connect three or more switches to form a ring topology to gain network redundancy

capabilities through the following steps.

1. Connect each switch to form a daisy chain using an Ethernet cable.
2. Set one of the connected switches to be the master and make sure the port setting of each connected switch on the management page corresponds to the physical ports connected. For information about the port setting, please refer to [4.1.2 Configurations](#).
3. Connect the last switch to the first switch to form a ring topology.

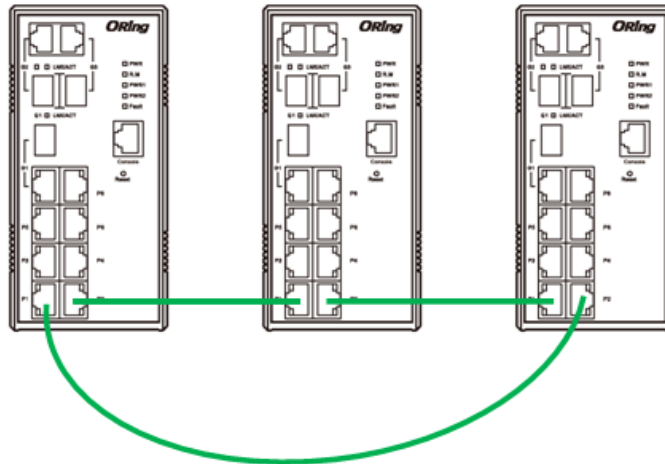

Coupling Ring

If you already have two O-Ring topologies and would like to connect the rings, you can form them into a coupling ring. All you need to do is select two switches from each ring to be connected, for example, switch A and B from Ring 1 and switch C and D from ring 2. Decide which port on each switch to be used as the coupling port and then link them together, for example, port 1 of switch A to port 2 of switch C and port 1 of switch B to port 2 of switch D. Then, enable Coupling Ring option by checking the checkbox on the management page and select the coupling ring in correspondence to the connected port. For more information on port setting, please refer to [4.1.2 Configurations](#). Once the setting is completed, one of the connections will act as the main path while the other will act as the backup path.

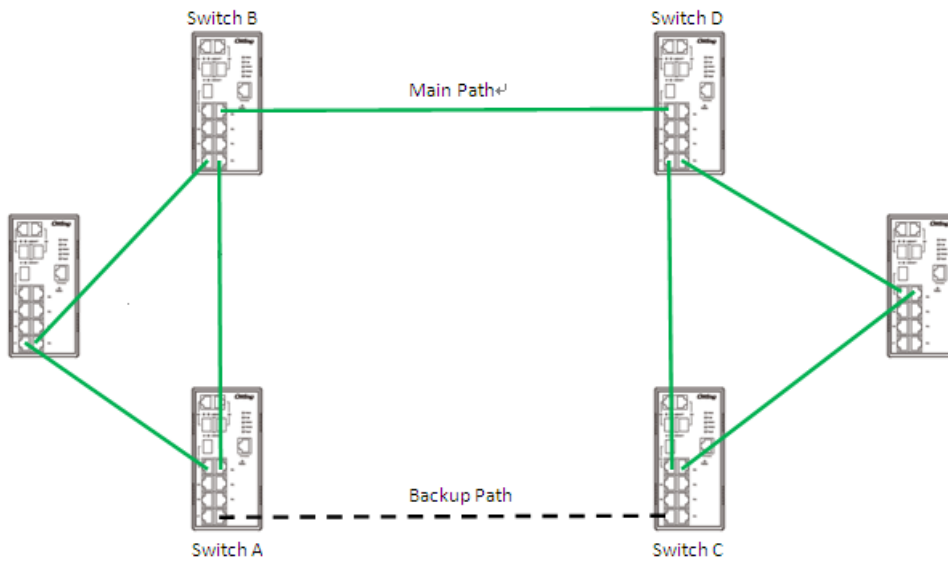

Dual Homing

If you want to connect your ring topology to a RSTP network environment, you can use dual homing. Choose two switches (Switch A & B) from the ring for connecting to the switches in the RSTP network (core switches). The connection of one of the switches (Switch A or B) will act as the primary path, while the other will act as the backup path that is activated when the primary path connection fails.

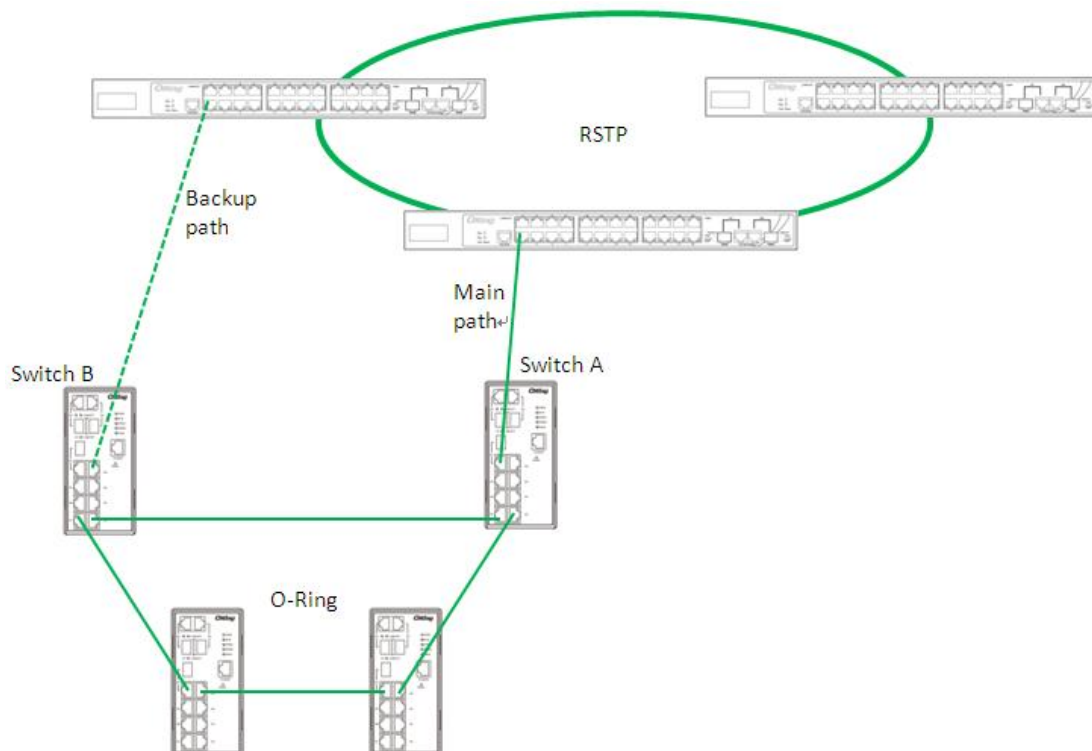

O-Chain

When connecting multiple O-Rings to meet your expansion demand, you can create an O-Chain topology through the following steps.

1. Select two switches from the chain (Switch A & B) that you want to connect to the O-Ring and connect them to the switches in the ring (Switch C & D).
2. In correspondence to the port connected to the ring, configure an edge port for both of the connected switches in the chain by checking the box in the management page (see [4.1.2 Configurations](#)).
3. Once the setting is completed, one of the connections will act as the main path, and the other as the backup path.

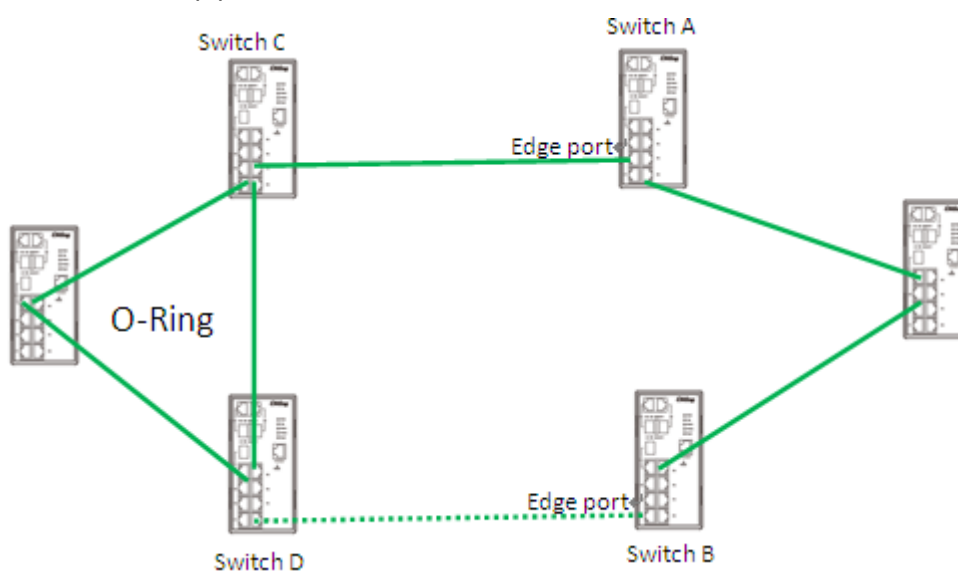

Redundancy

Redundancy for minimized system downtime is one of the most important concerns for industrial networking devices. Hence, ORing has developed proprietary redundancy technologies including O-Ring and Open-Ring featuring faster recovery time than existing redundancy technologies widely used in commercial applications, such as STP, RSTP, and MSTP. ORing’s proprietary redundancy technologies not only support different networking topologies, but also assure the reliability of the network.

4.1 O-Ring

4.1.1 Introduction

O-Ring is ORing's proprietary redundant ring technology, with recovery time of less than 30 milliseconds (in full-duplex Gigabit operation) or 10 milliseconds (in full-duplex Fast Ethernet operation) and up to 250 nodes. The ring protocols identify one switch as the master of the network, and then automatically block packets from traveling through any of the network’s redundant loops. In the event that one branch of the ring gets disconnected from the rest of the network, the protocol automatically readjusts the ring so that the part of the network that was disconnected can reestablish contact with the rest of the network. The O-Ring redundant ring technology can protect mission-critical applications from network interruptions or temporary malfunction with its fast recover technology.

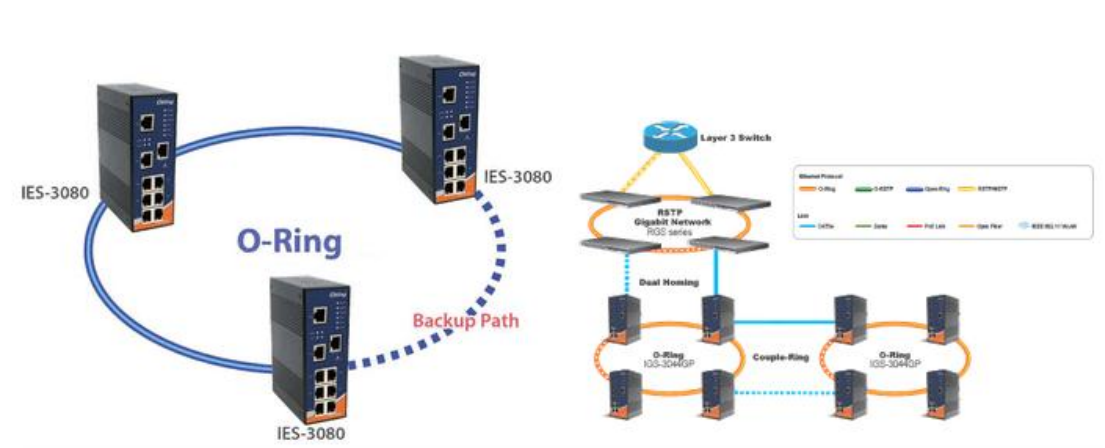

4.1.2 Configurations

O-Ring supports three ring topologies: **Ring Master**, **Coupling Ring**, and **Dual Homing**. You can configure the settings in the interface below.

O-Ring Configuration

<input checked="" type="checkbox"/> O-Ring		
Ring Master	Disable ▾	This switch is Not a Ring Master.
1st Ring Port	Port 1 ▾	LinkDown
2nd Ring Port	Port 2 ▾	LinkDown
<input type="checkbox"/> Coupling Ring		
Coupling Port	Port 3 ▾	LinkDown
<input type="checkbox"/> Dual Homing		
Homing Port	Port 4 ▾	LinkDown

Label	Description
Redundant Ring	Check to enable O-Ring topology.
Ring Master	Only one ring master is allowed in a ring. However, if more than one switches are set to enable Ring Master , the switch with the lowest MAC address will be the active ring master and the others will be backup masters.
1st Ring Port	The primary port when the switch is ring master
2nd Ring Port	The backup port when the switch is ring master
Coupling Ring	Check to enable Coupling Ring . Coupling Ring can divide a big ring into two smaller rings to avoid network topology changes affecting all switches. It is a good method for connecting two rings.
Coupling Port	Ports for connecting multiple rings. A coupling ring needs four switches to build an active and a backup link. Links formed by the coupling ports will run in active/backup mode.
Dual Homing	Check to enable Dual Homing . When Dual Homing is enabled, the ring will be connected to normal switches through two RSTP links (ex: backbone Switch). The two links work in active/backup mode, and connect each ring to the normal switches in RSTP mode.
Apply	Click to apply the configurations.

Note: due to heavy computing loading, setting one switch as ring master and coupling ring at the same time is not recommended.

4.2 OPEN-Ring

4.2.1 Introduction

Open-Ring is a technology developed by ORing to enhance ORing switches' interoperability with other vendors' products. With this technology, you can add any ORing switches to the network based on other ring technologies.

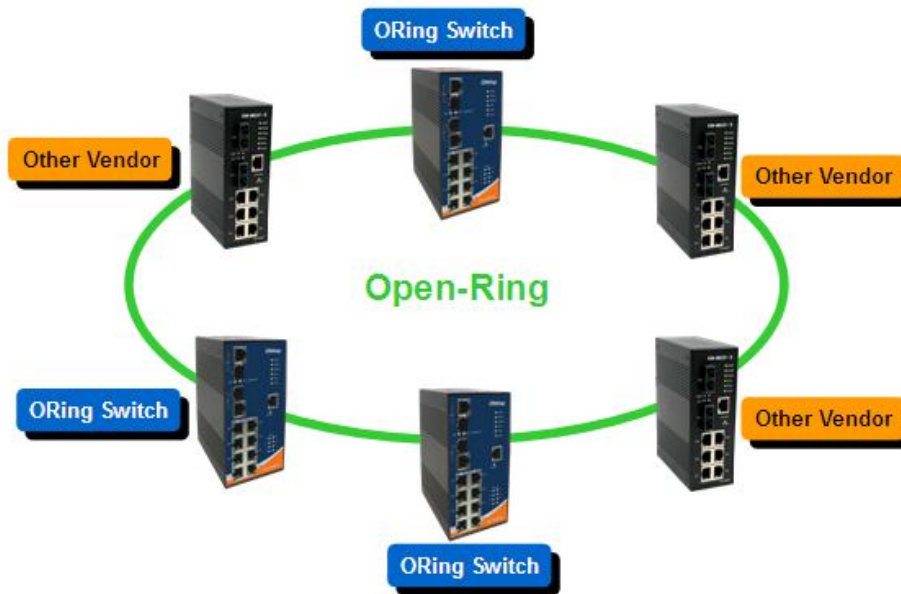

4.2.2 Configurations

Open-Ring

<input checked="" type="checkbox"/> Enable	
Vender	Moxx ▼
1st Ring Port	Port.01 ▼
2nd RingPort	Port.02 ▼

Label	Description
Enable	Check to enable Open-Ring topology
Vender	Choose the vendors that you want to join in their rings

1st Ring Port	The first port to connect to the ring
2nd Ring Port	The second port to connect to the ring

4.3 O-Chain

4.3.1 Introduction

O-Chain is ORing’s revolutionary network redundancy technology which enhances network redundancy for any backbone networks, providing ease-of-use and maximum fault-recovery swiftness, flexibility, compatibility, and cost-effectiveness in a set of network redundancy topologies. The self-healing Ethernet technology designed for distributed and complex industrial networks enables the network to recover in less than 30 milliseconds (in full-duplex Gigabit operation) or 10 milliseconds (in full-duplex Fast Ethernet operation) for up to 250 switches if at any time a segment of the chain fails.

O-Chain allows multiple redundant rings of different redundancy protocols to join and function together as a large and the most robust network topologies. It can create multiple redundant networks beyond the limitations of current redundant ring technologies.

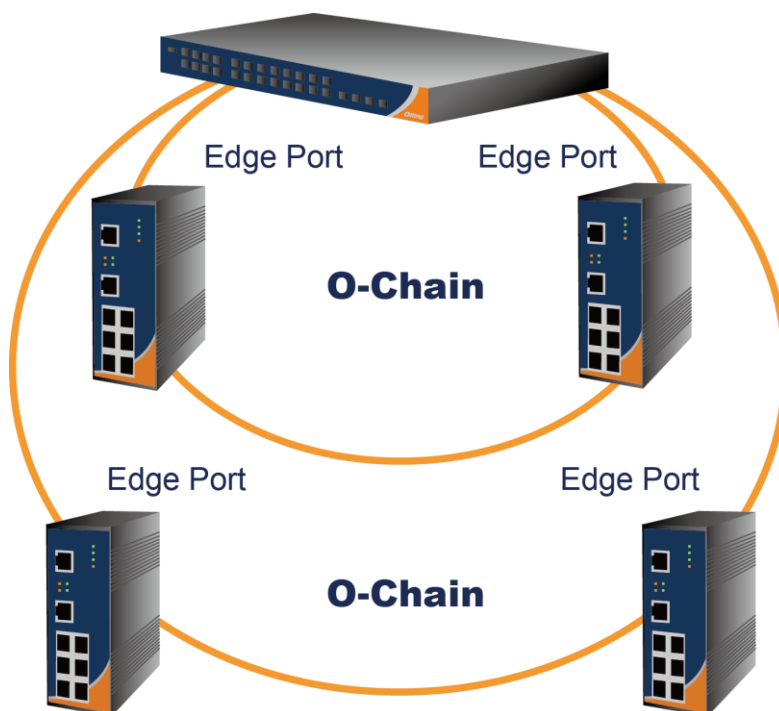

4.3.2 Configurations

O-Chain is very easy to configure and manage. Only one edge port of the edge switch needs to be defined. Other switches beside them just need to have O-Chain enabled.

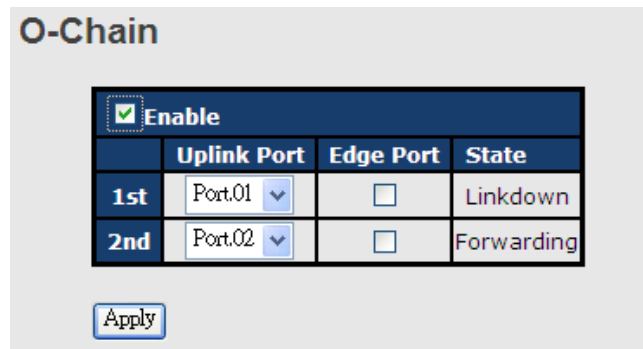

Label	Description
Enable	Check to enable O-Chain function
1st Ring Port	The first port connecting to the ring
2nd Ring Port	The second port connecting to the ring
Edge Port	An O-Chain topology must begin with edge ports. The ports with a smaller switch MAC address will serve as the backup link and RM LED will light up.

4.4 Bypass (TGS-9120-M12-BP2 Only)

4.4.1 Introduction

Bypass provides reliable and uninterrupted connections of inline network devices when any of the devices encounter hardware failure such as power outage. Figure 1 shows the topology consisting of switches without bypass function. When any of the devices breaks down, the network will lose connection.

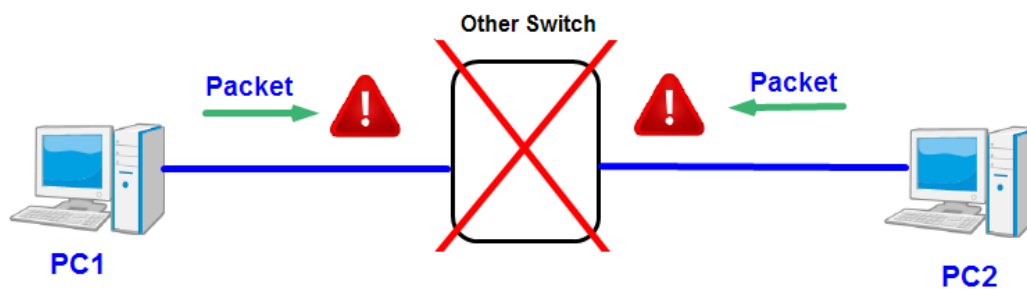

Figure 1

Figure 2 shows the topology consisting of switches with bypass functions. When one of the devices is unavailable, the network traffic will bypass the inactive device and continue to flow to other active devices, ensuring consistent connections.

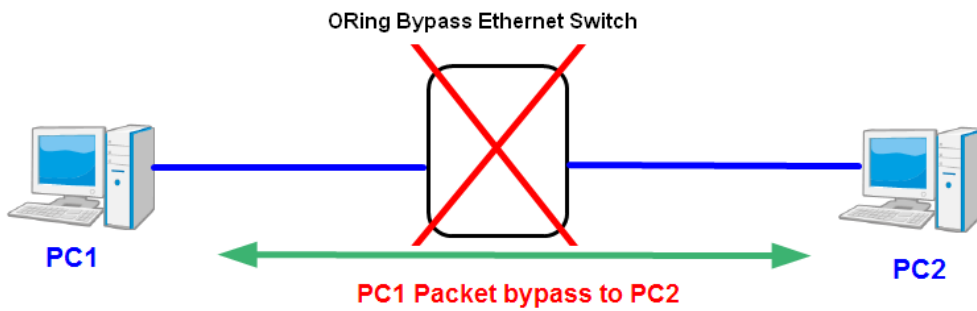
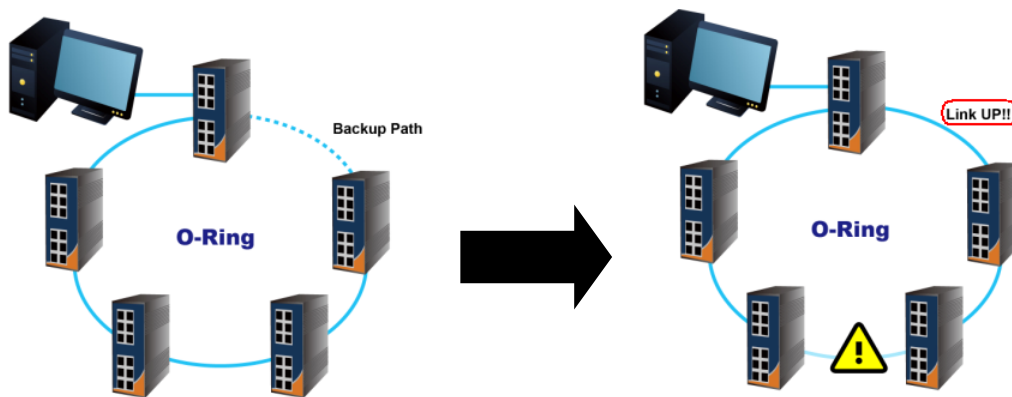

Figure 2

4.4.2 Bypass & Ring Topology

Bypass provides redundancy during device failure and O-Ring provides redundancy when links are broken. Together the two will provide users with dual protection when links and devices are broken.

In a ring topology where switches are not bypass-enabled, the backup link will be activated immediately when one of the links is down, thereby ensuring uninterrupted data transmission. However, if any inline device fails, the network will be disconnected (see below).



By using bypass-enabled switches in a ring topology, data will continue to flow to the next active switch through the same route when one or more inline devices fail. Data will bypass the inactive switches during transmission as if they do not exist. In this case, the backup path will remain inactive and the ring topology will remain unchanged (see below).

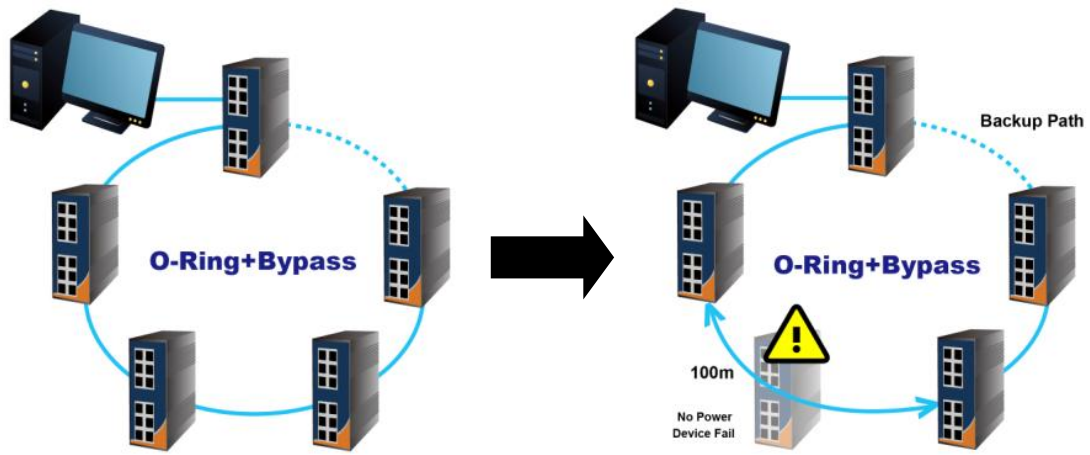

Fast Ethernet Networks

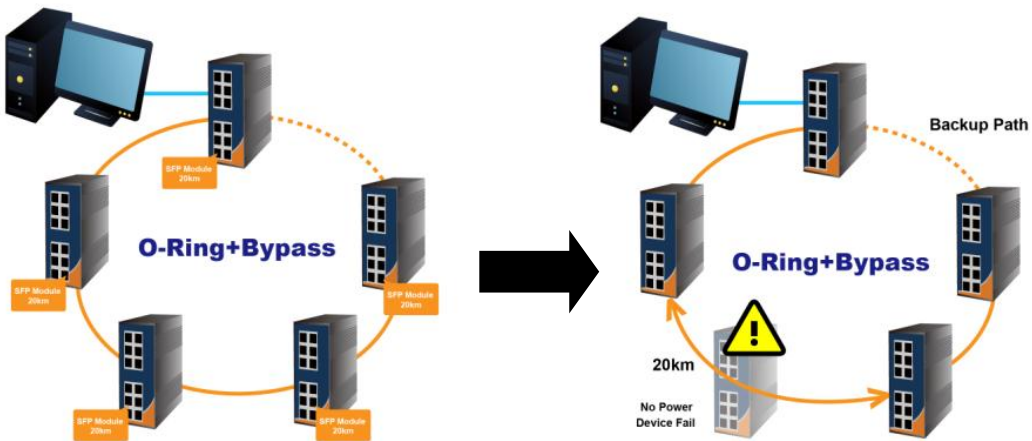

Fiber Networks

When a link between two switches fails following the breakdown of the switch, the backup link will be activated. Data will then be transmitted via the backup path (see below).

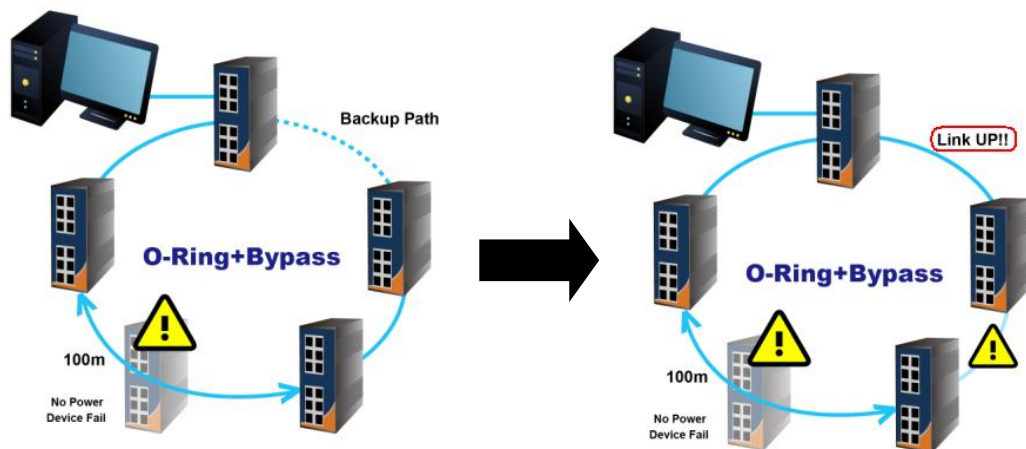

Fast Ethernet Networks

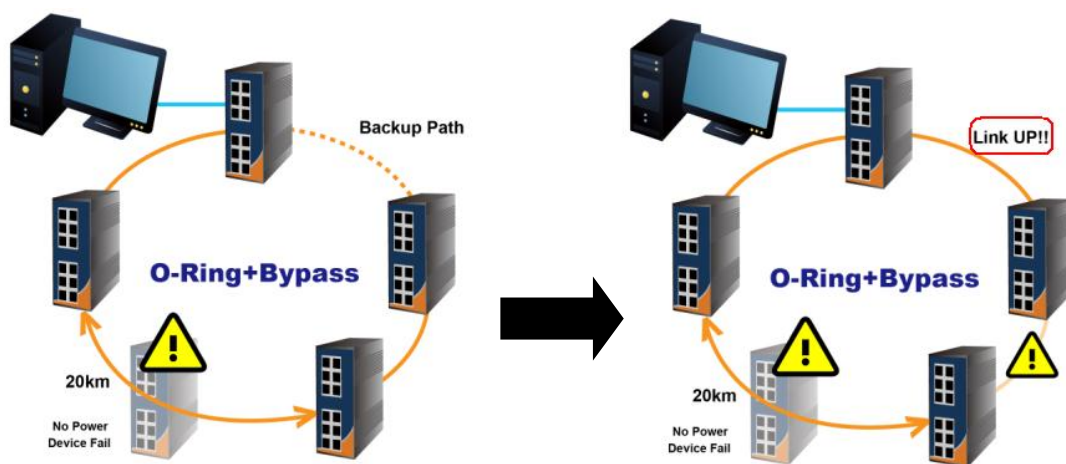

Fiber Networks

Note: The maximum cable length for copper ports is 100 meters and 20km for fiber ports. When data bypasses the inactive switch(s) to another active switch, the distance between the two active switches must be within the maximum length, otherwise transmission will fail.

4.5 MRP

4.5.1 Introduction

MRP (Media Redundancy Protocol) is an industry standard for high-availability Ethernet networks. MRP allowing Ethernet switches in ring configuration to recover from failure rapidly to ensure seamless data transmission. A MRP ring (IEC 62439) can support up to 50 devices and will enable a back-up link in 80ms (adjustable to max. 200ms/500ms).

4.5.2 Configurations

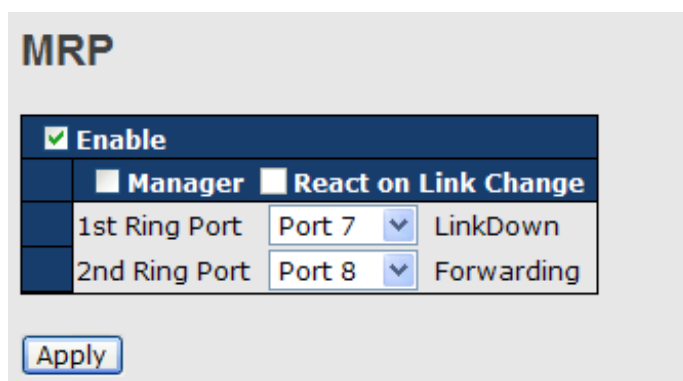

Label	Description
Enable	Enables the MRP function
Manager	Every MRP topology needs a MRP manager. One MRP topology can only have a Manager. If two or more switches are

	set to be Manager, the MRP topology will fail.
React on Link Change (Advanced mode)	Faster mode. Enabling this function will cause MRP topology to converge more rapidly. This function only can be set in MRP manager switch.
1st Ring Port	Chooses the port which connects to the MRP ring
2nd Ring Port	Chooses the port which connects to the MRP ring

4.6 STP/RSTP/MSTP

4.6.1 STP/RSTP

STP (Spanning Tree Protocol), and its advanced versions RSTP (Rapid Spanning Tree Protocol) and MSTP (Multiple Spanning Tree Protocol), are designed to prevent network loops and provide network redundancy. Network loops occur frequently in large networks as when two or more paths run to the same destination, broadcast packets may get in to an infinite loop and hence causing congestion in the network. STP can identify the best path to the destination, and block all other paths. The blocked links will stay connected but inactive. When the best path fails, the blocked links will be activated. Compared to STP which recovers a link in 30 to 50 seconds, RSTP can shorten the time to 5 to 6 seconds.

STP Bridge Status

This page shows the status for all STP bridge instance.

STP Bridges

Auto-refresh

MSTI	Bridge ID	Root			Topology Flag	Topology Change Last
		ID	Port	Cost		
	80:00-00:1E:94:FF:FF:FF	80:00-00:1E:94:FF:FF:FF	-	0	Steady	-

Label	Description
MSTI	The bridge instance. You can also link to the STP detailed bridge status.
Bridge ID	The bridge ID of this bridge instance.
Root ID	The bridge ID of the currently selected root bridge.
Root Port	The switch port currently assigned the root port role.
Root Cost	Root path cost. For a root bridge, this is zero. For other bridges, it is the sum of port path costs on the least cost path to the Root Bridge.
Topology Flag	The current state of the Topology Change Flag for the bridge

	instance.
Topology Change Last	The time since last Topology Change occurred.
Refresh	Click to refresh the page immediately.
Auto-refresh	Check this box to enable an automatic refresh of the page at regular intervals.

STP Port Status

This page displays the STP port status for the currently selected switch.

The screenshot shows the 'STP Port Status' page. At the top, there is a title 'STP Port Status' and a control area with an 'Auto-refresh' checkbox (unchecked) and a 'Refresh' button. Below this is a table with the following data:

Port	CIST Role	CIST State	Uptime
1	Non-STP	Forwarding	-
2	Non-STP	Forwarding	-
3	Non-STP	Forwarding	-
4	Non-STP	Forwarding	-
5	Non-STP	Forwarding	-
6	Non-STP	Forwarding	-
7	Non-STP	Forwarding	-
8	Non-STP	Forwarding	-
9	Non-STP	Forwarding	-
10	Non-STP	Forwarding	-
11	Non-STP	Forwarding	-
12	Non-STP	Forwarding	-

Label	Description
Port	The switch port number to which the following settings will be applied.
CIST Role	The current STP port role of the CIST port. The values include: AlternatePort , BackupPort , RootPort , and DesignatedPort .
State	The current STP port state of the CIST port. The values include: Blocking , Learning , and Forwarding .
Uptime	The time since the bridge port is last initialized
Refresh	Click to refresh the page immediately.
Auto-refresh	Check this box to enable an automatic refresh of the page at regular intervals.

STP Statistics

This page displays the STP port statistics for the currently selected switch.

STP Statistics

Auto-refresh

Port	Transmitted				Received				Discarded	
	MSTP	RSTP	STP	TCN	MSTP	RSTP	STP	TCN	Unknown	Illegal
No ports enabled										

Label	Description
Port	The switch port number to which the following settings will be applied.
RSTP	The number of RSTP configuration BPDUs received/transmitted on the port
STP	The number of legacy STP configuration BPDUs received/transmitted on the port
TCN	The number of (legacy) topology change notification BPDUs received/transmitted on the port
Discarded Unknown	The number of unknown spanning tree BPDUs received (and discarded) on the port.
Discarded Illegal	The number of illegal spanning tree BPDUs received (and discarded) on the port.
Refresh	Click to refresh the page immediately
Auto-refresh	Check to enable an automatic refresh of the page at regular intervals

STP Bridge Configurations

STP Bridge Configuration

Basic Settings

Protocol Version	MSTP ▼
Forward Delay	15
Max Age	20
Maximum Hop Count	20
Transmit Hold Count	6

Label	Description
Protocol Version	The version of the STP protocol. Valid values include STP, RSTP and MSTP.
Forward Delay	The delay used by STP bridges to transit root and designated

	ports to forwarding (used in STP compatible mode). The range of valid values is 4 to 30 seconds.
Max Age	The maximum time the information transmitted by the root bridge is considered valid. The range of valid values is 6 to 40 seconds, and Max Age must be $\leq (\text{FwdDelay}-1)*2$.
Maximum Hop Count	This defines the initial value of remaining hops for MSTI information generated at the boundary of an MSTI region. It defines how many bridges a root bridge can distribute its BPDU information to. The range of valid values is 4 to 30 seconds, and MaxAge must be $\leq (\text{FwdDelay}-1)*2$.
Transmit Hold Count	The number of BPDUs a bridge port can send per second. When exceeded, transmission of the next BPDU will be delayed. The range of valid values is 1 to 10 BPDUs per second.
Save	Click to save changes.
Reset	Click to undo any changes made locally and revert to previously saved values.

4.6.2 MSTP

Since the recovery time of STP and RSTP takes seconds, which are unacceptable in some industrial applications, MSTP was developed. The technology supports multiple spanning trees within a network by grouping and mapping multiple VLANs into different spanning-tree instances, known as MSTIs, to form individual MST regions. Each switch is assigned to an MST region. Hence, each MST region consists of one or more MSTP switches with the same VLANs, at least one MST instance, and the same MST region name. Therefore, switches can use different paths in the network to effectively balance loads.

Port Settings

This page allows you to examine and change the configurations of current MSTI ports. A MSTI port is a virtual port, which is instantiated separately for each active CIST (physical) port for each MSTI instance configured and applicable for the port. The MSTI instance must be selected before MSTI port configuration options are displayed.

This page contains MSTI port settings for physical and aggregated ports. The aggregation settings are stack global.

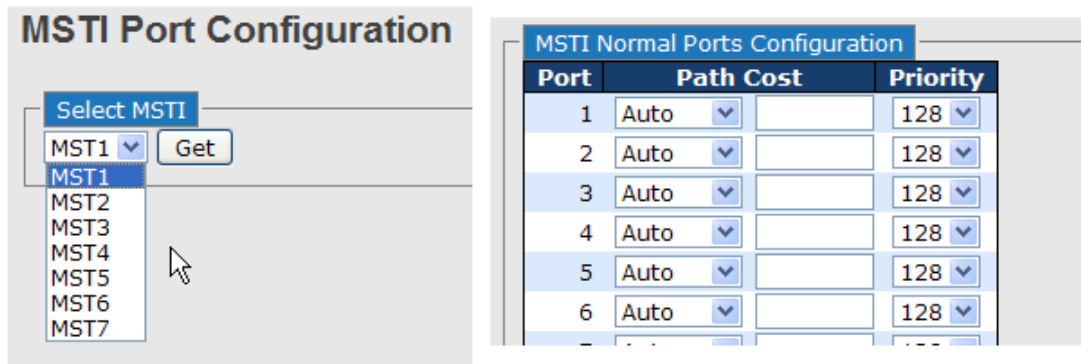

Label	Description
Port	The switch port number of the corresponding STP CIST (and MSTI) port
Path Cost	Configures the path cost incurred by the port. Auto will set the path cost according to the physical link speed by using the 802.1D-recommended values. Specific allows you to enter a user-defined value. The path cost is used when establishing an active topology for the network. Lower path cost ports are chosen as forwarding ports in favor of higher path cost ports. The range of valid values is 1 to 200000000.
Priority	Configures the priority for ports having identical port costs. (See above).
Save	Click to save changes.
Reset	Click to undo any changes made locally and revert to previously saved values.

Mapping

This page allows you to examine and change the configurations of current STP MSTI bridge instance.

MSTI Configuration

Add VLANs separated by spaces or comma.

Unmapped VLANs are mapped to the CIST. (The default bridge instance).

Configuration Identification

Configuration Name	00-1e-94-ff-ff-ff
Configuration Revision	0

MSTI Mapping

MSTI	VLANs Mapped
MST1	
MST2	
MST3	
MST4	
MST5	
MST6	
MST7	

Save Reset

Label	Description
Configuration Name	The name which identifies the VLAN to MSTI mapping. Bridges must share the name and revision (see below), as well as the VLAN-to-MSTIs mapping configurations in order to share spanning trees for MSTIs (intra-region). The name should not exceed 32 characters.
Configuration Revision	Revision of the MSTI configuration named above. This must be an integer between 0 and 65535.
MSTI	The bridge instance. The CIST is not available for explicit mapping, as it will receive the VLANs not explicitly mapped.
VLANs Mapped	The list of VLANs mapped to the MSTI. The VLANs must be separated with commas and/or space. A VLAN can only be mapped to one MSTI. An unused MSTI will be left empty (ex. without any mapped VLANs).
Save	Click to save changes.
Reset	Click to undo any changes made locally and revert to previously saved values.

Priority

This page allows you to examine and change the configurations of current STP MSTI bridge instance priority.

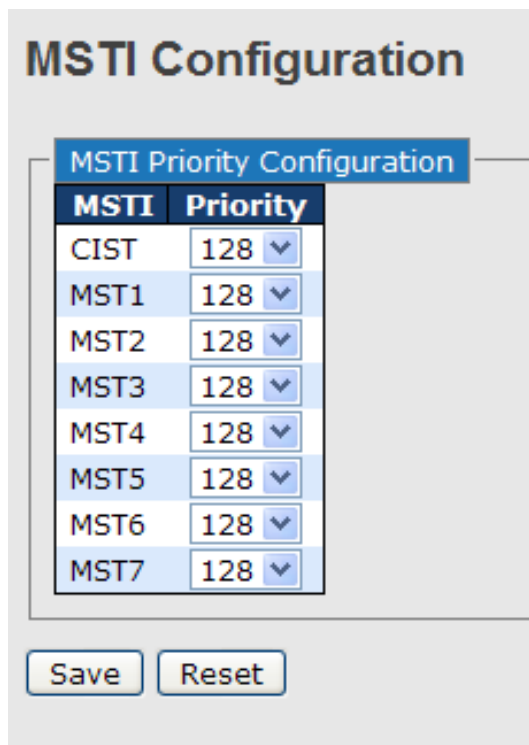

Label	Description
MSTI	The bridge instance. CIST is the default instance, which is always active.
Priority	Indicates bridge priority. The lower the value, the higher the priority. The bridge priority, MSTI instance number, and the 6-byte MAC address of the switch forms a bridge identifier.
Save	Click to save changes
Reset	Click to undo any changes made locally and revert to previously saved values

4.6.3 CIST

With the ability to cross regional boundaries, CIST is used by MSTP to communicate with other MSTP regions and with any RSTP and STP single-instance spanning trees in the network. Any boundary port, that is, if it is connected to another region, will automatically belongs solely to CIST, even if it is assigned to an MSTI. All VLANs that are not members of particular MSTIs are members of the CIST.

Port Settings

STP CIST Ports Configuration

CIST Aggregated Ports Configuration

Port	STP Enabled	Path Cost	Priority	Admin Edge	Auto Edge	Restricted Role	TCN	BPDU Guard	Point-to-point
-	<input type="checkbox"/>	Auto	128	Edge	<input checked="" type="checkbox"/>	<input type="checkbox"/>	<input type="checkbox"/>	<input type="checkbox"/>	Forced True

CIST Normal Ports Configuration

Port	STP Enabled	Path Cost	Priority	Admin Edge	Auto Edge	Restricted Role	TCN	BPDU Guard	Point-to-point
1	<input type="checkbox"/>	Auto	128	Edge	<input checked="" type="checkbox"/>	<input type="checkbox"/>	<input type="checkbox"/>	<input type="checkbox"/>	Auto
2	<input type="checkbox"/>	Auto	128	Edge	<input checked="" type="checkbox"/>	<input type="checkbox"/>	<input type="checkbox"/>	<input type="checkbox"/>	Auto
3	<input type="checkbox"/>	Auto	128	Edge	<input checked="" type="checkbox"/>	<input type="checkbox"/>	<input type="checkbox"/>	<input type="checkbox"/>	Auto
4	<input type="checkbox"/>	Auto	128	Edge	<input checked="" type="checkbox"/>	<input type="checkbox"/>	<input type="checkbox"/>	<input type="checkbox"/>	Auto
5	<input type="checkbox"/>	Auto	128	Edge	<input checked="" type="checkbox"/>	<input type="checkbox"/>	<input type="checkbox"/>	<input type="checkbox"/>	Auto
6	<input type="checkbox"/>	Auto	128	Edge	<input checked="" type="checkbox"/>	<input type="checkbox"/>	<input type="checkbox"/>	<input type="checkbox"/>	Auto

Label	Description
Port	The switch port number to which the following settings will be applied.
STP Enabled	Check to enable STP for the port
Path Cost	Configures the path cost incurred by the port. Auto will set the path cost according to the physical link speed by using the 802.1D-recommended values. Specific allows you to enter a user-defined value. The path cost is used when establishing an active topology for the network. Lower path cost ports are chosen as forwarding ports in favor of higher path cost ports. The range of valid values is 1 to 200000000.
Priority	Configures the priority for ports having identical port costs. (See above).
OpenEdge (setate flag)	A flag indicating whether the port is connected directly to edge devices or not (no bridges attached). Transiting to the forwarding state is faster for edge ports (operEdge set to true) than other ports.
AdminEdge	Configures the operEdge flag to start as set or cleared.(the initial operEdge state when a port is initialized).
AutoEdge	Check to enable the bridge to detect edges at the bridge port automatically. This allows operEdge to be derived from whether BPDUs are received on the port or not.
Restricted Role	When enabled, the port will not be selected as root port for CIST or any MSTI, even if it has the best spanning tree priority vector. Such a port will be selected as an alternate port after the root port

	has been selected. If set, spanning trees will lose connectivity. It can be set by a network administrator to prevent bridges outside a core region of the network from influencing the active spanning tree topology because those bridges are not under the full control of the administrator. This feature is also known as Root Guard.
Restricted TCN	When enabled, the port will not propagate received topology change notifications and topology changes to other ports. If set, it will cause temporary disconnection after changes in an active spanning trees topology as a result of persistent incorrectly learned station location information. It is set by a network administrator to prevent bridges outside a core region of the network from causing address flushing in that region because those bridges are not under the full control of the administrator or is the physical link state for the attached LANs transitions frequently.
Point2Point	Configures whether the port connects to a point-to-point LAN rather than a shared medium. This can be configured automatically or set to true or false manually. Transiting to forwarding state is faster for point-to-point LANs than for shared media.
Save	Click to save changes.
Reset	Click to undo any changes made locally and revert to previously saved values.

4.7 Fast Recovery

Fast recovery mode can be set to connect multiple ports to one or more switches. The device with fast recovery mode will provide redundant links. Fast recovery mode supports 12 priorities. Only the first priority will be the active port, and the other ports with different priorities will be backup ports.

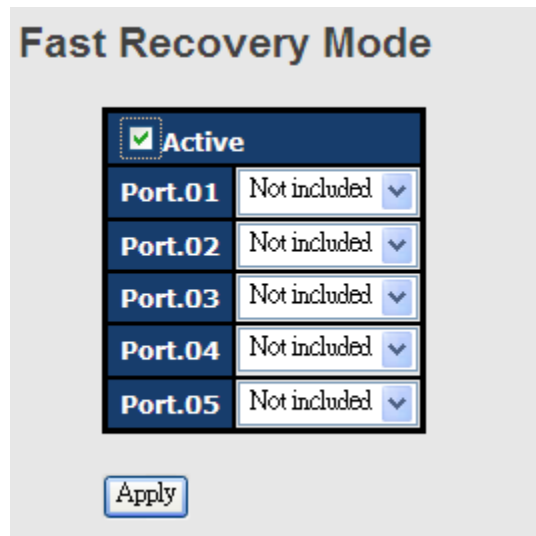

Label	Description
Active	Activate fast recovery mode
port	Ports can be set to 12 priorities. Only the port with the highest priority will be the active port. 1st Priority is the highest.
Apply	Click to activate the configurations.

Management

The switch can be controlled via a built-in web server which supports Internet Explorer (Internet Explorer 5.0 or above versions) and other Web browsers such as Chrome. Therefore, you can manage and configure the switch easily and remotely. You can also upgrade firmware via a Web browser. The Web management function not only reduces network bandwidth consumption, but also enhances access speed and provides a user-friendly viewing screen.

Note: By default, IE5.0 or later version do not allow Java applets to open sockets. You need to modify the browser setting separately in order to enable Java applets for network ports.

Management via Web Browser

Follow the steps below to manage your switch via a Web browser

System Login

1. Launch an Internet Explorer.
2. Type `http://` and the IP address of the switch. Press **Enter**.

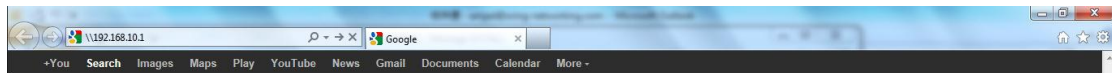

3. A login screen appears.
4. Type in the username and password. The default username and password is **admin**.
5. Press **Enter** or click **OK**, the management page appears.



Note: you can use the following default values:

IP Address: **192.168.10.1**

Subnet Mask: **255.255.255.0**

Default Gateway: **192.168.10.254**

User Name: **admin**

Password: **admin**

After logging in, you will see the information of the switch as below.

System	
Name	TGS-9120-M12-BP2
Description	EN50155 12-port managed Gigabit Ethernet switch with 12x10/100/1000Base-T(X), M12 connector and 2xbypass included
Location	
Contact	
OID	1.3.6.1.4.1.25972.100.6.0.143
Hardware	
MAC Address	00-1e-94-02-0c-18
Time	
System Date	1970-01-01 00:00:29+00:00
System Uptime	0d 00:00:29
Software	
Kernel Version	v9.21
Software Version	v1.00
Software Date	2014-10-21T13:58:04+08:00

Auto-refresh

On the right hand side of the management interface shows links to various settings. Clicking on the links will bring you to individual configuration pages.

5.1 Basic Settings

The Basic Settings page allows you to configure the basic functions of the switch.

5.1.1 System Information

This page shows the general information of the switch.

System Information Configuration

System Name	TGS-9120-M12-BP2
System Description	EN50155 12-port managed Gig
System Location	
System Contact	

Label	Description
System Name	An administratively assigned name for the managed node. By convention, this is the node's fully-qualified domain name. A domain name is a text string consisting of alphabets (A-Z, a-z), digits (0-9), and minus sign (-). Space is not allowed to be part of the name. The first character must be an alpha character. And the first or last character must not be a minus sign. The allowed string length is 0 to 255.
System Description	Description of the device
System Location	The physical location of the node (e.g., telephone closet, 3rd floor). The allowed string length is 0 to 255, and only ASCII characters from 32 to 126 are allowed.
System Contact	The textual identification of the contact person for this managed node, together with information on how to contact this person. The allowed string length is 0 to 255, and only ASCII characters from 32 to 126 are allowed.
Save	Click to save changes.
Reset	Click to undo any changes made locally and revert to previously saved values.

5.1.2 Admin & Password

This page allows you to configure the system password required to access the web pages or log in from CLI.

Label	Description
Old Password	The existing password. If this is incorrect, you cannot set the new password.
New Password	The new system password. The allowed string length is 0 to 31, and only ASCII characters from 32 to 126 are allowed.

Confirm New Password	Re-type the new password.
Save	Click to save changes.

5.1.3 Authentication Methods

This page allows you to configure how a user is authenticated when he/she logs into the switch via one of the management interfaces.

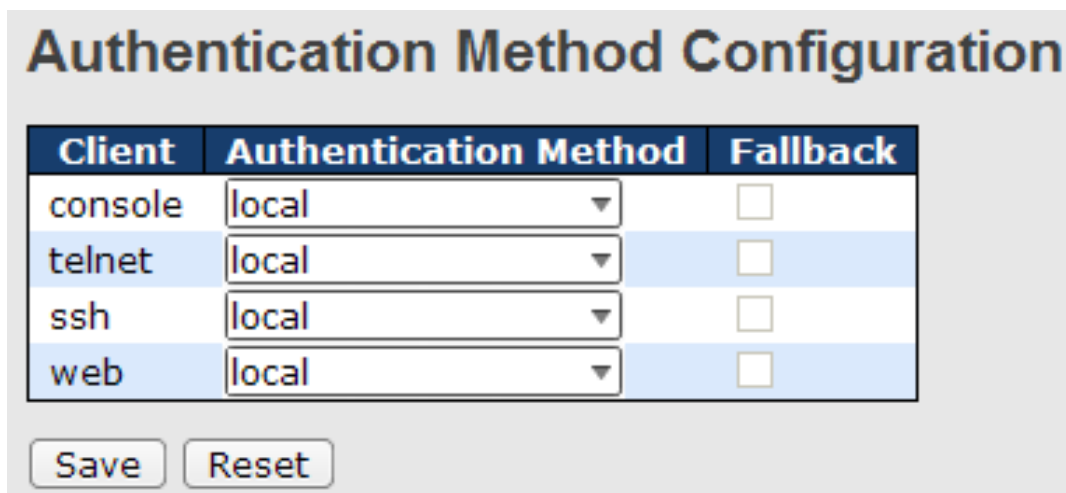

Label	Description
Client	The management client for which the configuration below applies.
Authentication Method	Authentication Method can be set to one of the following values: None: authentication is disabled and login is not possible. Local: local user database on the switch is used for authentication. Radius: a remote RADIUS server is used for authentication.
Fallback	Check to enable fallback to local authentication. If none of the configured authentication servers are active, the local user database is used for authentication. This is only possible if Authentication Method is set to a value other than none or local .
Save	Click to save changes
Reset	Click to undo any changes made locally and revert to previously saved values

5.1.4 IP Settings

This page allows you to configure IP information for the switch. You can specify configure the settings manually by disabling DHCP Client. After inputting the values, click **Renew** and the

new values will be applied, which will be displayed under **Current**.

IP Configuration

	Configured	Current
DHCP Client	<input type="checkbox"/>	<input type="button" value="Renew"/>
IP Address	<input type="text" value="192.168.10.1"/>	192.168.10.1
IP Mask	<input type="text" value="255.255.255.0"/>	255.255.255.0
IP Router	<input type="text" value="0.0.0.0"/>	0.0.0.0
VLAN ID	<input type="text" value="1"/>	1
DNS Server	<input type="text" value="0.0.0.0"/>	0.0.0.0

Label	Description
DHCP Client	Enable the DHCP client by checking this box. If DHCP fails or the configured IP address is zero, DHCP will retry. If DHCP retry fails, DHCP will stop trying and the configured IP settings will be used.
IP Address	Assigns the IP address of the network in use. If DHCP client function is enabled, you do not need to assign the IP address. The network DHCP server will assign an IP address to the switch and it will be displayed in this column. The default IP is 192.168.10.1 .
IP Mask	Assigns the subnet mask of the IP address. If DHCP client function is enabled, you do not need to assign the subnet mask.
IP Router	Assigns the network gateway for the switch. The default gateway is 192.168.10.254 .
VLAN ID	Provides the managed VLAN ID. The allowed range is 1 through 4095.
DNS Server	Enter the IP address of the DNS server in dotted decimal notation.
Save	Click to save changes
Reset	Click to undo any changes made locally and revert to previously saved values

5.1.5 IPv6 Settings

IPv6 is the next-generation IP that uses a 128-bit address standard. It is developed to supplement, and eventually replace the IPv4 protocol. You can configure IPv6 information of the switch on the following page.

IPv6 Configuration

	Configured	Current
Auto Configuration	<input type="checkbox"/>	<input type="button" value="Renew"/>
Address	<input type="text" value="::192.0.2.1"/>	::192.0.2.1 Link-Local Address: fe80::21e:94ff:fe01:6735
Prefix	<input type="text" value="96"/>	96
Router	<input type="text" value="::"/>	::

Label	Description
Auto Configuration	Check to enable IPv6 auto-configuration. If the system cannot obtain the stateless address in time, the configured IPv6 settings will be used. The router may delay responding to a router solicitation for a few seconds; therefore, the total time needed to complete auto-configuration may be much longer.
Address	Specify an IPv6 address for the switch. IPv6 address consists of 128 bits represented as eight groups of four hexadecimal digits with a colon separating each field (:). For example, in 'fe80::215:c5ff:fe03:4dc7', the symbol '::' is a special syntax that can be used as a shorthand way of representing multiple 16-bit groups of contiguous zeros; but it can appear only once. It can also represent a legally valid IPv4 address. For example, '::192.1.2.34'.
Prefix	Specify an IPv6 prefix for the switch. The allowed range is 1 to 128.
Router	Specify an IPv6 address for the switch. IPv6 address consists of 128 bits represented as eight groups of four hexadecimal digits with a colon separating each field (:). For example, in 'fe80::215:c5ff:fe03:4dc7', the symbol '::' is a special syntax that can be used as a shorthand way of representing multiple 16-bit groups of contiguous zeros; but it can appear only once. It can also represent a legally valid IPv4 address. For example, '::192.1.2.34'.
Save	Click to save changes
Reset	Click to undo any changes made locally and revert to previously saved values

5.1.6 Daylight Saving Time

Time Zone Configuration

Time Zone Configuration	
Time Zone	None ▼
Acronym	<input type="text" value=""/> (0 - 16 characters)

Label	Description
Time Zone	Select an appropriate time zone from the drop down list according to the location of the device and then click Save .
Acronym	You can set an acronym for the time zone for identification (up to 16 alpha-numeric characters are allowed and can contain '-', '_' or '!')

Daylight Saving Time Configuration

Daylight Saving Time Mode	
Daylight Saving Time	Disabled ▼
Start Time settings	
Month	Jan ▼
Date	1 ▼
Year	2000 ▼
Hours	0 ▼
Minutes	0 ▼
End Time settings	
Month	Jan ▼
Date	1 ▼
Year	2000 ▼
Hours	0 ▼
Minutes	0 ▼
Offset settings	
Offset	1 (1 - 1440) Minutes

Label	Description
Daylight Saving Time	This is used to set the clock forward or backward according to the configurations set below for a defined Daylight Saving Time duration. Select Disable to disable the Daylight Saving Time configuration. Select Recurring and the Daylight Saving Time

	duration will repeat the configuration every year. Select Non-Recurring and the Daylight Saving Time duration will only take effect once. (Default is Disabled)
Recurring Configurations - Start time settings	
Label	Description
Month	Select the starting month.
Date	Select the starting date.
Year	Select the starting year.
Hours	Select the starting hour.
Minutes	Select the starting minute.
Recurring Configurations - Ending time settings	
Label	Description
Month	Select the ending month
Date	Select the ending date
Year	Select the ending year.
Hours	Select the ending hour
Minutes	Select the ending minute.
Recurring Configurations – Offset settings	
Label	Description
offset	Enter the number of minutes to add during Daylight Saving Time. (Range from 1 to 1440)
Non Recurring Configurations – Start Time settings	
Label	Description
Month	Select the starting month.
Date	Select the starting date.
Year	Select the starting year.
Hours	Select the starting hour.
Minutes	Select the starting minute.
Non-Recurring Configurations – End Time settings	
Label	Description
Month	Select the ending month.
Date	Select the ending date.
Year	Select the ending year.
Hours	Select the ending hour.
Minutes	Select the ending minute.
Non-Recurring Configurations – Offset settings	

Label	Description
Offset	Enter the number of minutes to add during Daylight Saving Time. (Range from 1 to 1440)

5.1.7 HTTPS

You can configure the HTTPS mode in the following page.

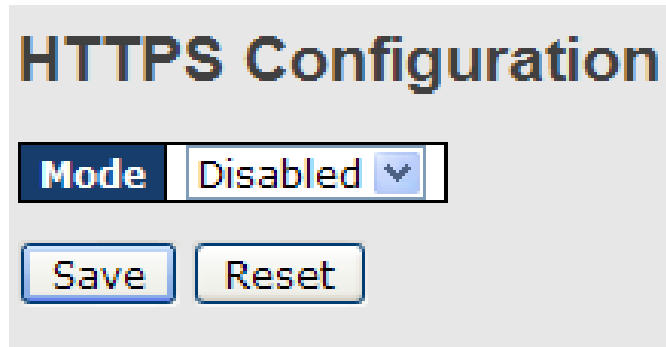

Label	Description
Mode	Indicates the selected HTTPS mode. When the current connection is HTTPS, disabling HTTPS will automatically redirect web browser to an HTTP connection. The modes include: Enabled: enable HTTPS. Disabled: disable HTTPS.
Save	Click to save changes
Reset	Click to undo any changes made locally and revert to previously saved values

5.1.8 SSH

SSH (Secure Shell) is a cryptographic network protocol intended for secure data transmission and remote access by creating a secure channel between two networked PCs. You can configure the SSH mode in the following page.

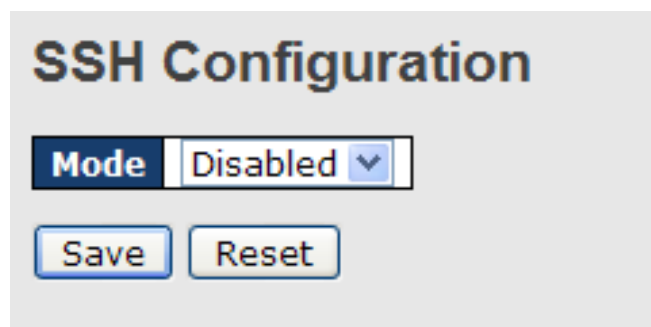

Label	Description
Mode	Indicates the selected SSH mode. The modes include: Enabled: enable SSH. Disabled: disable SSH.
Save	Click to save changes
Reset	Click to undo any changes made locally and revert to previously saved values

5.1.9 LLDP

LLDP Configurations

LLDP (Link Layer Discovery Protocol) provides a method for networked devices to receive and/or transmit their information to other connected devices on the network that are also using the protocols, and to store the information that is learned about other devices. This page allows you to examine and configure current LLDP port settings.

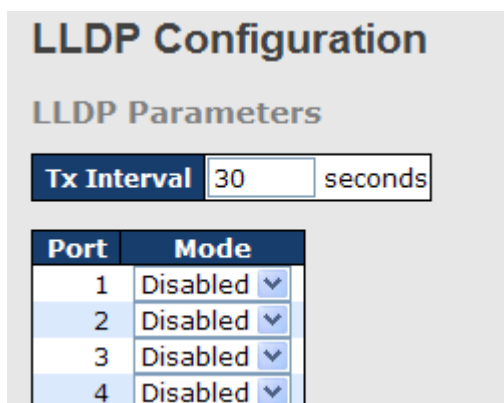

Label	Description
Port	The switch port number to which the following settings will be applied.
Mode	Indicates the selected LLDP mode Rx only: the switch will not send out LLDP information, but LLDP information from its neighbors will be analyzed. Tx only: the switch will drop LLDP information received from its neighbors, but will send out LLDP information. Disabled: the switch will not send out LLDP information, and will drop LLDP information received from its neighbors. Enabled: the switch will send out LLDP information, and will analyze LLDP information received from its neighbors.

LLDP Neighbor Information

This page provides a status overview for all LLDP neighbors. The following table contains information for each port on which an LLDP neighbor is detected. The columns include the following information:

Local Port	Chassis ID	Remote Port ID	System Name	Port Description	System Capabilities	Management Address
Port 8	00-1E-94-12-45-78	7	IGS-9812GP	Port #7	Bridge(+)	192.168.10.14 (IPv4)

Label	Description
Local Port	The port that you use to transmits and receives LLDP frames.
Chassis ID	The identification number of the neighbor sending out the LLDP frames.
Remote Port ID	The identification of the neighbor port
System Name	The name advertised by the neighbor.
Port Description	The description of the port advertised by the neighbor.
System Capabilities	Description of the neighbor's capabilities. The capabilities include: <ol style="list-style-type: none"> 1. Other 2. Repeater 3. Bridge 4. WLAN Access Point 5. Router 6. Telephone 7. DOCSIS Cable Device 8. Station Only 9. Reserved When a capability is enabled, a (+) will be displayed. If the capability is disabled, a (-) will be displayed.
Management Address	The neighbor's address which can be used to help network management. This may contain the neighbor's IP address.
Refresh	Click to refresh the page immediately
Auto-refresh	Check to enable an automatic refresh of the page at regular intervals

Port Statistics

This page provides an overview of all LLDP traffic. Two types of counters are shown. Global counters will apply settings to the whole switch stack, while local counters will apply settings to specified switches.

Auto-refresh Refresh Clear

Global Counters	
Neighbor entries were last changed at 1970-01-01 04:03:03 +0000 (26 sec. ago)	
Total Neighbors Entries Added	1
Total Neighbors Entries Deleted	0
Total Neighbors Entries Dropped	0
Total Neighbors Entries Aged Out	0

LLDP Statistics

Local Counters								
Local Port	Tx Frames	Rx Frames	Rx Errors	Frames Discarded	TLVs Discarded	TLVs Unrecognized	Org. Discarded	Age-Outs
1	1	0	0	0	0	0	0	0
2	0	0	0	0	0	0	0	0
3	4	0	0	0	0	0	0	0
4	0	0	0	0	0	0	0	0
5	2	1	0	0	0	0	0	0
6	0	0	0	0	0	0	0	0
7	0	0	0	0	0	0	0	0
8	1	0	0	0	0	0	0	0
9	0	0	0	0	0	0	0	0
10	0	0	0	0	0	0	0	0
11	0	0	0	0	0	0	0	0
12	0	0	0	0	0	0	0	0

Global Counters

Label	Description
Neighbor entries were last changed at	Shows the time when the last entry was deleted or added.
Total Neighbors Entries Added	Shows the number of new entries added since switch reboot
Total Neighbors Entries Deleted	Shows the number of new entries deleted since switch reboot
Total Neighbors Entries Dropped	Shows the number of LLDP frames dropped due to full entry table
Total Neighbors Entries Aged Out	Shows the number of entries deleted due to expired time-to-live

Local Counters

Label	Description
Local Port	The port that receives or transmits LLDP frames
Tx Frames	The number of LLDP frames transmitted on the port
Rx Frames	The number of LLDP frames received on the port
Rx Errors	The number of received LLDP frames containing errors
Frames Discarded	If a port receives an LLDP frame, and the switch's internal table is full, the LLDP frame will be counted and discarded. This situation is known as "too many neighbors" in the LLDP standard. LLDP frames require a new entry in the table if Chassis ID or Remote Port ID is not included in the table. Entries are removed from the table when a given port links down, an LLDP shutdown frame is

	received, or when the entry ages out.
TLVs Discarded	Each LLDP frame can contain multiple pieces of information, known as TLVs (Type Length Value). If a TLV is malformed, it will be counted and discarded.
TLVs Unrecognized	The number of well-formed TLVs, but with an unknown type value
Org. Discarded	The number of organizationally TLVs received
Age-Outs	Each LLDP frame contains information about how long the LLDP information is valid (age-out time). If no new LLDP frame is received during the age-out time, the LLDP information will be removed, and the value of the age-out counter will be incremented.
Refresh	Click to refresh the page immediately
Clear	Click to clear the local counters. All counters (including global counters) are cleared upon reboot.
Auto-refresh	Check to enable an automatic refresh of the page at regular intervals

5.1.10 NTP

Network Time Protocol (NTP) is a networking protocol for clock synchronization between computer systems over packet-switched

NTP Configuration

Mode	Disabled <input type="button" value="v"/>
Server 1	<input type="text"/>
Server 2	<input type="text"/>
Server 3	<input type="text"/>
Server 4	<input type="text"/>
Server 5	<input type="text"/>

Date	<input type="text" value="1970-01-01"/>
Time	<input type="text" value="02:18:36"/>

Label	Description
Mode	Indicates the NTP mode operation. Possible modes are:

	<p>Enabled: Enable NTP client mode operation.</p> <p>Disabled: Disable NTP client mode operation.</p>
Server	<p>Provide the IPv4 or IPv6 address of a NTP server. IPv6 address is in 128-bit records represented as eight fields of up to four hexadecimal digits with a colon separating each field (:). For example, 'fe80::215:c5ff:fe03:4dc7'. The symbol '::' is a special syntax that can be used as a shorthand way of representing multiple 16-bit groups of contiguous zeros; but it can appear only once. It can also represent a legally valid IPv4 address. For example, '::192.1.2.34'.</p>
Date	Show date value
Time	Show time value

5.1.11 Modbus TCP

Modbus TCP uses TCP/IP and Ethernet to carry the data of the Modbus message structure between compatible devices. The protocol is commonly used in SCADA systems for communications between a human-machine interface (HMI) and programmable logic controllers. This page enables you to enable and disable Modbus TCP support of the switch.

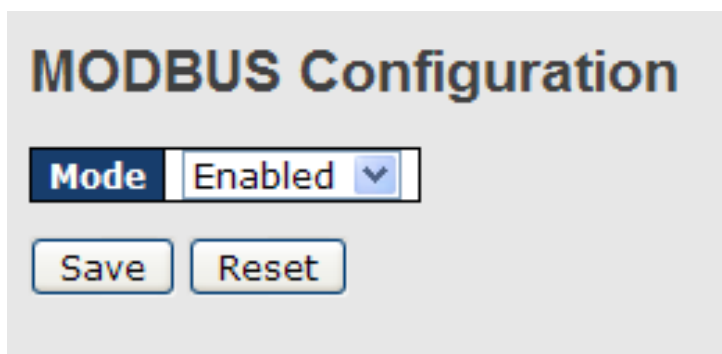

Label	Description
Mode	Shows the existing status of the Modbus TCP function

5.1.12 Backup/Restore Configurations

You can save/view or load switch configurations. The configuration file is in XML format.

Configuration Save

Save configuration

Configuration Upload

瀏覽... Upload

5.1.13 Firmware Update

This page allows you to update the firmware of the switch.

Firmware Update

瀏覽... Upload

5.2 DHCP Server

The switch provides DHCP server functions. By enabling DHCP, the switch will become a DHCP server and dynamically assigns IP addresses and related IP information to network clients.

5.2.1 Basic Settings

This page allows you to set up DHCP settings for the switch. You can check the **Enabled** checkbox to activate the function. Once the box is checked, you will be able to input information in each column.

DHCP Server Configuration

Enabled	<input checked="" type="checkbox"/>
Start IP Address	192.168.10.100
End IP Address	192.168.10.200
Subnet Mask	255.255.255.0
Router	192.168.10.254
DNS	192.168.10.254
Lease Time (sec.)	86400
TFTP Server	0.0.0.0
Boot File Name	

5.2.2 Dynamic Client List

When DHCP server functions are activated, the switch will collect DHCP client information and display in the following table. You can select the entries and add them to a static table by clicking **Add to static Table**.

DHCP Dynamic Client List

No.	Select	Type	MAC Address	IP Address	Surplus Lease
-----	--------	------	-------------	------------	---------------

5.2.3 Client List

You can assign a specific IP address within the dynamic IP range to a specific port. When a device is connected to the port and requests for dynamic IP assigning, the switch will assign the IP address that has previously been assigned to the connected device.

DHCP Client List

MAC Address	<input style="width: 100%;" type="text"/>
IP Address	<input style="width: 100%;" type="text"/>

No.	Select	Type	MAC Address	IP Address	Surplus Lease
-----	--------	------	-------------	------------	---------------

5.2.4 Relay Agent

DHCP relay is used to forward and transfer DHCP messages between the clients and the server when they are not in the same subnet domain. You can configure the function in this page.

Label	Description
Relay Mode	<p>Indicates the existing DHCP relay mode. The modes include:</p> <p>Enabled: activate DHCP relay. When DHCP relay is enabled, the agent forwards and transfers DHCP messages between the clients and the server when they are not in the same subnet domain to prevent the DHCP broadcast message from flooding for security considerations.</p> <p>Disabled: disable DHCP relay</p>
Relay Server	<p>Indicates the DHCP relay server IP address. A DHCP relay agent is used to forward and transfer DHCP messages between the clients and the server when they are not in the same subnet domain.</p>
Relay Information Mode	<p>Indicates the existing DHCP relay information mode. The format of DHCP option 82 circuit ID format is "[vlan_id][module_id][port_no]". The first four characters represent the VLAN ID, and the fifth and sixth characters are the module ID. In stand-alone devices, the module ID always equals to 0; in stacked devices, it means switch ID. The last two characters are the port number. For example, "00030108" means the DHCP message received from VLAN ID 3, switch ID 1, and port No. 8. The option 82 remote ID value equals to the switch MAC address.</p> <p>The modes include:</p> <p>Enabled: activate DHCP relay information. When DHCP relay information is enabled, the agent inserts specific information (option 82) into a DHCP message when forwarding to a DHCP server and removes it from a DHCP message when transferring to</p>

	a DHCP client. It only works when DHCP relay mode is enabled. Disabled: disable DHCP relay information
Relay Information Policy	Indicates the policies to be enforced when receiving DHCP relay information. When DHCP relay information mode is enabled, if the agent receives a DHCP message that already contains relay agent information, it will enforce the policy. The Replace option is invalid when relay information mode is disabled. The policies includes: Replace: replace the original relay information when a DHCP message containing the information is received. Keep: keep the original relay information when a DHCP message containing the information is received. Drop: drop the package when a DHCP message containing the information is received.

The relay statistics shows the information of relayed packets of the switch.

Auto-refresh

DHCP Relay Statistics

Server Statistics

Transmit to Server	Transmit Error	Receive from Server	Receive Missing Agent Option	Receive Missing Circuit ID	Receive Missing Remote ID	Receive Bad Circuit ID	Receive Bad Remote ID
0	0	0	0	0	0	0	0

Label	Description
Transmit to Sever	The number of packets relayed from the client to the server
Transmit Error	The number of packets with errors when being sent to clients
Receive from Server	The number of packets received from the server
Receive Missing Agent Option	The number of packets received without agent information
Receive Missing Circuit ID	The number of packets received with Circuit ID
Receive Missing Remote ID	The number of packets received with the Remote ID option missing.
Receive Bad Circuit ID	The number of packets whose Circuit ID do not match the known circuit ID
Receive Bad Remote ID	The number of packets whose Remote ID do not match the known Remote ID

Client Statistics

Transmit to Client	Transmit Error	Receive from Client	Receive Agent Option	Replace Agent Option	Keep Agent Option	Drop Agent Option
0	0	0	0	0	0	0

Label	Description
Transmit to Client	The number of packets relayed from the server to the client
Transmit Error	The number of packets with errors when being sent to servers
Receive from Client	The number of packets received from the server
Receive Agent Option	The number of received packets containing relay agent information
Replace Agent Option	The number of packets replaced when received messages contain relay agent information.
Keep Agent Option	The number of packets whose relay agent information is retained
Drop Agent Option	The number of packets dropped when received messages contain relay agent information.

5.3 Port Setting

Port Setting allows you to manage individual ports of the switch, including traffic, power, and trunks.

5.3.1 Port Control

This page shows current port configurations. Ports can also be configured here.

Port Configuration

Refresh								
Port	Link	Speed		Flow Control			Maximum Frame Size	Power Control
		Current	Configured	Current Rx	Current Tx	Configured		
*			<>				9600	<>
1	Down	Down	Auto	X	X		9600	Disabled
2	Down	Down	Auto	X	X		9600	Disabled
3	Down	Down	Auto	X	X		9600	Disabled
4	Down	Down	Auto	X	X		9600	Disabled
5	100fdx	Down	Auto	X	X		9600	Disabled
6	Down	Down	Auto	X	X		9600	Disabled
7	1Gfdx	Down	Auto	X	X		9600	Disabled
8	1Gfdx	Down	Auto	X	X		9600	Disabled
9	Down	Down	Auto	X	X		9600	
10	Down	Down	Auto	X	X		9600	
11	Down	Down	Auto	X	X		9600	

Label	Description
-------	-------------

Port	The switch port number to which the following settings will be applied.
Link	The current link state is shown by different colors. Green indicates the link is up and red means the link is down.
Current Link Speed	Indicates the current link speed of the port
Configured Link Speed	<p>The drop-down list provides available link speed options for a given switch port</p> <p>Auto selects the highest speed supported by the link partner</p> <p>Disabled disables switch port configuration</p> <p><> configures all ports</p>
Flow Control	<p>When Auto is selected for the speed, the flow control will be negotiated to the capacity advertised by the link partner.</p> <p>When a fixed-speed setting is selected, that is what is used.</p> <p>Current Rx indicates whether pause frames on the port are obeyed, and Current Tx indicates whether pause frames on the port are transmitted. The Rx and Tx settings are determined by the result of the last auto-negotiation.</p> <p>You can check the Configured column to use flow control. This setting is related to the setting of Configured Link Speed.</p>
Maximum Frame	You can enter the maximum frame size allowed for the switch port in this column, including FCS. The allowed range is 1518 bytes to 9600 bytes.
Power Control	<p>Shows the current power consumption of each port in percentage.</p> <p>The Configured column allows you to change power saving parameters for each port.</p> <p>Disabled: all power savings functions are disabled</p> <p>ActiPHY: link down and power savings enabled</p> <p>PerfectReach: link up and power savings enabled</p> <p>Enabled: both link up and link down power savings enabled</p>
Total Power Usage	Total power consumption of the board, measured in percentage
Save	Click to save changes
Reset	Click to undo any changes made locally and revert to previously saved values
Refresh	Click to refresh the page. Any changes made locally will be undone.

5.3.2 Port Trunk

A port trunk is a group of ports that have been grouped together to function as one logical path. This method provides an economical way for you to increase the bandwidth between the switch and another networking device. In addition, it is useful when a single physical link between the devices is insufficient to handle the traffic load. This page allows you to configure the aggregation hash mode and the aggregation group.

Aggregation Mode Configuration

Hash Code Contributors	
Source MAC Address	<input checked="" type="checkbox"/>
Destination MAC Address	<input type="checkbox"/>
IP Address	<input checked="" type="checkbox"/>
TCP/UDP Port Number	<input checked="" type="checkbox"/>

Label	Description
Source MAC Address	Calculates the destination port of the frame. You can check this box to enable the source MAC address, or uncheck to disable. By default, Source MAC Address is enabled.
Destination MAC Address	Calculates the destination port of the frame. You can check this box to enable the destination MAC address, or uncheck to disable. By default, Destination MAC Address is disabled.
IP Address	Calculates the destination port of the frame. You can check this box to enable the IP address, or uncheck to disable. By default, IP Address is enabled.
TCP/UDP Port Number	Calculates the destination port of the frame. You can check this box to enable the TCP/UDP port number, or uncheck to disable. By default, TCP/UDP Port Number is enabled.

Aggregation Group Configuration

Group ID	Port Members											
	1	2	3	4	5	6	7	8	9	10	11	12
Normal	<input checked="" type="checkbox"/>	<input checked="" type="checkbox"/>	<input checked="" type="checkbox"/>	<input checked="" type="checkbox"/>	<input checked="" type="checkbox"/>	<input checked="" type="checkbox"/>	<input checked="" type="checkbox"/>	<input checked="" type="checkbox"/>	<input checked="" type="checkbox"/>	<input checked="" type="checkbox"/>	<input checked="" type="checkbox"/>	<input checked="" type="checkbox"/>
1	<input type="checkbox"/>	<input type="checkbox"/>	<input type="checkbox"/>	<input type="checkbox"/>	<input type="checkbox"/>	<input type="checkbox"/>	<input type="checkbox"/>	<input type="checkbox"/>	<input type="checkbox"/>	<input type="checkbox"/>	<input type="checkbox"/>	<input type="checkbox"/>
2	<input type="checkbox"/>	<input type="checkbox"/>	<input type="checkbox"/>	<input type="checkbox"/>	<input type="checkbox"/>	<input type="checkbox"/>	<input type="checkbox"/>	<input type="checkbox"/>	<input type="checkbox"/>	<input type="checkbox"/>	<input type="checkbox"/>	<input type="checkbox"/>
3	<input type="checkbox"/>	<input type="checkbox"/>	<input type="checkbox"/>	<input type="checkbox"/>	<input type="checkbox"/>	<input type="checkbox"/>	<input type="checkbox"/>	<input type="checkbox"/>	<input type="checkbox"/>	<input type="checkbox"/>	<input type="checkbox"/>	<input type="checkbox"/>
4	<input type="checkbox"/>	<input type="checkbox"/>	<input type="checkbox"/>	<input type="checkbox"/>	<input type="checkbox"/>	<input type="checkbox"/>	<input type="checkbox"/>	<input type="checkbox"/>	<input type="checkbox"/>	<input type="checkbox"/>	<input type="checkbox"/>	<input type="checkbox"/>
5	<input type="checkbox"/>	<input type="checkbox"/>	<input type="checkbox"/>	<input type="checkbox"/>	<input type="checkbox"/>	<input type="checkbox"/>	<input type="checkbox"/>	<input type="checkbox"/>	<input type="checkbox"/>	<input type="checkbox"/>	<input type="checkbox"/>	<input type="checkbox"/>
6	<input type="checkbox"/>	<input type="checkbox"/>	<input type="checkbox"/>	<input type="checkbox"/>	<input type="checkbox"/>	<input type="checkbox"/>	<input type="checkbox"/>	<input type="checkbox"/>	<input type="checkbox"/>	<input type="checkbox"/>	<input type="checkbox"/>	<input type="checkbox"/>

Label	Description
-------	-------------

Group ID	Indicates the ID of each aggregation group. Normal means no aggregation. Only one group ID is valid per port.
Port Members	Lists each switch port for each group ID. Select a radio button to include a port in an aggregation, or clear the radio button to remove the port from the aggregation. By default, no ports belong to any aggregation group. Only full duplex ports can join an aggregation and the ports must be in the same speed in each group.

5.3.3 LACP

LACP (Link Aggregation Control Protocol) trunks are similar to static port trunks, but they are more flexible because LACP is compliant with the IEEE 802.3ad standard. Hence, it is interoperable with equipment from other vendors that also comply with the standard. This page allows you to enable LACP functions to group ports together to form single virtual links and change associated settings, thereby increasing the bandwidth between the switch and other LACP-compatible devices.

LACP Port Configuration

Port	LACP Enabled	Key	Role
1	<input type="checkbox"/>	Auto ▼	Active ▼
2	<input type="checkbox"/>	Auto ▼	Active ▼
3	<input type="checkbox"/>	Auto ▼	Active ▼
4	<input type="checkbox"/>	Auto ▼	Active ▼
5	<input type="checkbox"/>	Auto ▼	Active ▼
6	<input type="checkbox"/>	Auto ▼	Active ▼
7	<input type="checkbox"/>	Auto ▼	Active ▼
8	<input type="checkbox"/>	Auto ▼	Active ▼
9	<input type="checkbox"/>	Auto ▼	Active ▼
10	<input type="checkbox"/>	Auto ▼	Active ▼
11	<input type="checkbox"/>	Auto ▼	Active ▼
12	<input type="checkbox"/>	Auto ▼	Active ▼

Label	Description
Port	Indicates the ID of each aggregation group. Normal indicates there is no aggregation. Only one group ID is valid per port.
LACP Enabled	Lists each switch port for each group ID. Check to include a port in an

	aggregation, or clear the box to remove the port from the aggregation. By default, no ports belong to any aggregation group. Only full duplex ports can join an aggregation and the ports must be in the same speed in each group.
Key	The Key value varies with the port, ranging from 1 to 65535. Auto will set the key according to the physical link speed (10Mb = 1, 100Mb = 2, 1Gb = 3). Specific allows you to enter a user-defined value. Ports with the same key value can join in the same aggregation group, while ports with different keys cannot.
Role	Indicates LACP activity status. Active will transmit LACP packets every second, while Passive will wait for a LACP packet from a partner (speak if spoken to).
Save	Click to save changes
Reset	Click to undo changes made locally and revert to previous values

LACP System Status

This page provides a status overview for all LACP instances.

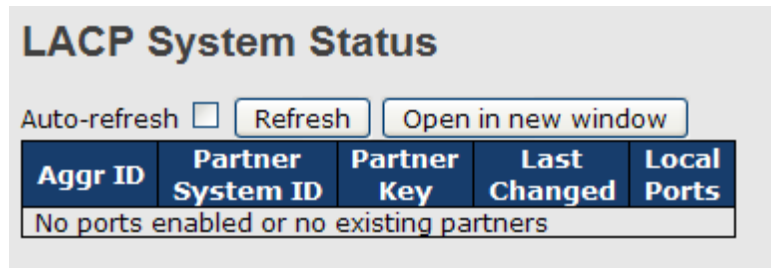

Label	Description
Aggr ID	The aggregation ID is associated with the aggregation instance. For LLAG, the ID is shown as ' isid:aggr-id ' and for GLAGs as ' aggr-id '
Partner System ID	System ID (MAC address) of the aggregation partner
Partner Key	The key assigned by the partner to the aggregation ID
Last Changed	The time since this aggregation changed.
Last Changed	Indicates which ports belong to the aggregation of the switch/stack. The format is: " Switch ID:Port ".
Refresh	Click to refresh the page immediately
Auto-refresh	Check to enable an automatic refresh of the page at regular intervals

LACP Status

This page provides an overview of the LACP status for all ports.

LACP Status

Auto-refresh
Refresh
Open in new window

Port	LACP	Key	Aggr ID	Partner System ID	Partner Port
1	No	-	-	-	-
2	No	-	-	-	-
3	No	-	-	-	-
4	No	-	-	-	-
5	No	-	-	-	-
6	No	-	-	-	-
7	No	-	-	-	-
8	No	-	-	-	-
9	No	-	-	-	-
10	No	-	-	-	-
11	No	-	-	-	-
12	No	-	-	-	-

Label	Description
Port	Switch port number
LACP	Yes means LACP is enabled and the port link is up. No means LACP is not enabled or the port link is down. Backup means the port cannot join in the aggregation group unless other ports are removed. The LACP status is disabled.
Key	The key assigned to the port. Only ports with the same key can be aggregated
Aggr ID	The aggregation ID assigned to the aggregation group
Partner System ID	The partner's system ID (MAC address)
Partner Port	The partner's port number associated with the port
Refresh	Click to refresh the page immediately
Auto-refresh	Check to enable an automatic refresh of the page at regular intervals

LACP Statistics

This page provides an overview of the LACP statistics for all ports.

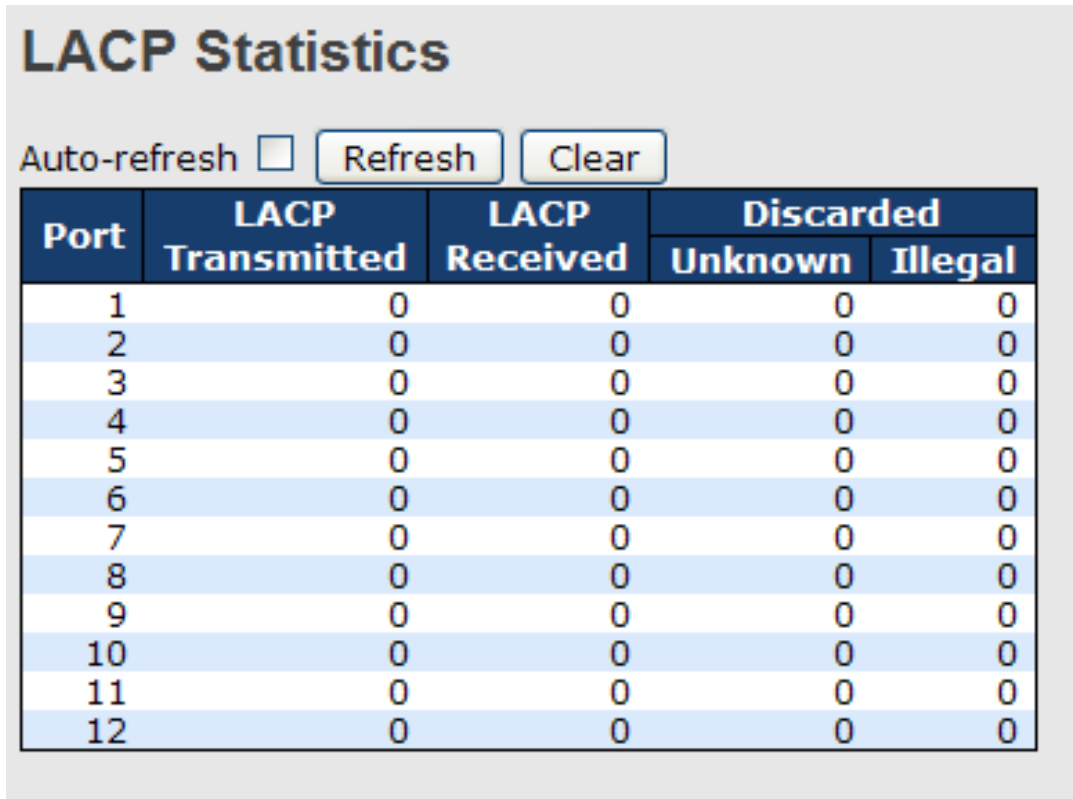

Label	Description
Port	Switch port number
LACP Transmitted	The number of LACP frames sent from each port
LACP Received	The number of LACP frames received at each port
Discarded	The number of unknown or illegal LACP frames discarded at each port.
Refresh	Click to refresh the page immediately
Auto-refresh	Check to enable an automatic refresh of the page at regular intervals
Clear	Click to clear the counters for all ports

5.3.4 Loop Gourd

This feature prevents loop attack. When receiving loop packets, the port will be disabled automatically, preventing the loop attack from affecting other network devices.

Global Configuration	
Enable Loop Protection	Disable ▾
Transmission Time	5 seconds
Shutdown Time	180 seconds

Label	Description
Enable Loop Protection	Activate loop protection functions (as a whole)
Transmission Time	The interval between each loop protection PDU sent on each port. The valid value is 1 to 10 seconds.
Shutdown Time	The period (in seconds) for which a port will be kept disabled when a loop is detected (shutting down the port). The valid value is 0 to 604800 seconds (7 days). A value of zero will keep a port disabled permanently (until the device is restarted).

Port	Enable	Action	Tx Mode
*	<input checked="" type="checkbox"/>	<> ▾	<> ▾
1	<input checked="" type="checkbox"/>	Shutdown Port ▾	Enable ▾
2	<input checked="" type="checkbox"/>	Shutdown Port ▾	Enable ▾
3	<input checked="" type="checkbox"/>	Shutdown Port ▾	Enable ▾
4	<input checked="" type="checkbox"/>	Shutdown Port ▾	Enable ▾
5	<input checked="" type="checkbox"/>	Shutdown Port ▾	Enable ▾
6	<input checked="" type="checkbox"/>	Shutdown Port ▾	Enable ▾

Label	Description
Port	Switch port number
Enable	Activate loop protection functions (as a whole)
Action	Configures the action to take when a loop is detected. Valid values include Shutdown Port , Shutdown Port , and Log or Log Only .
Tx Mode	Controls whether the port is actively generating loop protection PDUs or only passively look for looped PDUs.

5.4 VLAN

5.4.1 VLAN Membership

A VLAN is a group of end devices with a common set of requirements, independent of physical location. With the same attributes as a physical LAN, VLANs enable you to group end devices even if they are not located physically on the same LAN segment. By splitting up a network into sets of VLANs, assigning ports to individual VLANs, and defining criteria for VLAN membership for workstations connected to those ports, traffic for the same VLAN can be sent between switches.

VLAN Membership Configuration

Refresh | << >>

Start from VLAN with entries per page.

Delete	VLAN ID	VLAN Name	Port Members											
			1	2	3	4	5	6	7	8	9	10	11	12
<input type="checkbox"/>	1	default	<input checked="" type="checkbox"/>	<input checked="" type="checkbox"/>	<input checked="" type="checkbox"/>	<input checked="" type="checkbox"/>	<input checked="" type="checkbox"/>	<input checked="" type="checkbox"/>	<input checked="" type="checkbox"/>	<input checked="" type="checkbox"/>	<input checked="" type="checkbox"/>	<input checked="" type="checkbox"/>	<input checked="" type="checkbox"/>	<input checked="" type="checkbox"/>

Add New VLAN

Save Reset

Label	Description
Delete	Check to delete the entry. It will be deleted during the next save.
VLAN ID	The VLAN ID for a tagged port.
VLAN Name	The name of the VLAN.
Port Members	Check to select the ports belonging to individual VLAN.
Add New VLAN	<p>Click to add a new VLAN ID. An empty row is added to the table, and the VLAN can be configured as needed. Valid values for a VLAN ID are 1 through 4095.</p> <p>After clicking Save, the new VLAN will be enabled on the selected switch stack but contains no port members.</p> <p>A VLAN without any port members on any stack will be deleted when you click Save.</p> <p>Click Delete to undo the addition of new VLANs.</p>

5.4.2 Port Configurations

With port-based VLANs, the ports of a switch are simply assigned to VLANs, with no extra criteria. All devices connected to a given port automatically become members of the VLAN to which that port was assigned. In effect, this just divides a switch up into a set of independent sub-switches.

Auto-refresh Refresh

Ethertype for Custom S-ports 0x88A8

VLAN Port Configuration

Port	Port Type	Ingress Filtering	Frame Type	Port VLAN		Tx Tag
				Mode	ID	
*	<>	<input type="checkbox"/>	<>	<>	1	<>
1	Unaware	<input type="checkbox"/>	All	Specific	1	Untag_pvid
2	Unaware	<input type="checkbox"/>	All	Specific	1	Untag_pvid
3	Unaware	<input type="checkbox"/>	All	Specific	1	Untag_pvid
4	Unaware	<input type="checkbox"/>	All	Specific	1	Untag_pvid
5	Unaware	<input type="checkbox"/>	All	Specific	1	Untag_pvid
6	Unaware	<input type="checkbox"/>	All	Specific	1	Untag_pvid
7	Unaware	<input type="checkbox"/>	All	Specific	1	Untag_pvid
8	Unaware	<input type="checkbox"/>	All	Specific	1	Untag_pvid
9	Unaware	<input type="checkbox"/>	All	Specific	1	Untag_pvid
10	Unaware	<input type="checkbox"/>	All	Specific	1	Untag_pvid
11	Unaware	<input type="checkbox"/>	All	Specific	1	Untag_pvid
12	Unaware	<input type="checkbox"/>	All	Specific	1	Untag_pvid

Save Reset

Label	Description
Ethertype for customer S-Ports	This field specifies the EtherType used for custom S-ports. This is a global setting for all custom S-ports. Custom EtherType enables you to change the EtherType value on a port to any value to support network devices that do not use the standard 0x8100 EtherType field value on 802.1Q-tagged or 802.1p-tagged frames. When Port Type is set to S-custom-port, the EtherType (also known as TPID) of all frames received on the port is changed to the specified value. By default, the EtherType is set to 0x88a8 (IEEE 802.1ad)
Port	The switch port to which the following settings will be applied.
Port type	Port can be one of the following types: Unaware , Customer (C-port) , Service (S-port) , Custom Service (S-custom-port) . C-port: each frame is assigned to the VLAN indicated in the

	<p>VLAN tag, and the tag is removed.</p> <p>S-port: the EtherType of all received frames is changed to 0x88a8 to indicate that double-tagged frames are being forwarded across the switch. The switch will pass these frames on to the VLAN indicated in the outer tag. It will not strip the outer tag, nor change any components of the tag other than the EtherType field.</p> <p>S-custom-port: the EtherType of all received frames is changed to value set in the Ethertype for Custom S-ports field to indicate that double-tagged frames are being forwarded across the switch. The switch will pass these frames on to the VLAN indicated in the outer tag. It will not strip the outer tag, nor change any components of the tag other than the EtherType field.</p> <p>Unaware: all frames are classified to the Port VLAN ID and tags are not removed</p>
<p>Ingress Filtering</p>	<p>Enable ingress filtering on a port by checking the box. This parameter affects VLAN ingress processing. If ingress filtering is enabled and the ingress port is not a member of the classified VLAN of the frame, the frame will be discarded. By default, ingress filtering is disabled (no check mark).</p>
<p>Frame Type</p>	<p>Determines whether the port accepts all frames or only tagged/untagged frames. This parameter affects VLAN ingress processing. If the port only accepts tagged frames, untagged frames received on the port will be discarded. By default, the field is set to All.</p>
<p>Port VLAN Mode</p>	<p>The allowed values are None or Specific. This parameter affects VLAN ingress and egress processing.</p> <p>If None is selected, a VLAN tag with the classified VLAN ID is inserted in frames transmitted on the port. This mode is normally used for ports connected to VLAN-aware switches. Tx tag should be set to Untag_pvid when this mode is used.</p> <p>If Specific (the default value) is selected, a port VLAN ID can be configured (see below). Untagged frames received on the port are classified to the port VLAN ID. If VLAN awareness is disabled, all frames received on the port are classified to the port VLAN ID. If the classified VLAN ID of a frame transmitted on the port is different from the port VLAN ID, a VLAN tag with the classified</p>

	VLAN ID will be inserted in the frame.
Port VLAN ID	Configures the VLAN identifier for the port. The allowed range of the values is 1 through 4095. The default value is 1. Note: The port must be a member of the same VLAN as the port VLAN ID.
Tx Tag	Determines egress tagging of a port. Untag_pvid : all VLANs except the configured PVID will be tagged. Tag_all : all VLANs are tagged. Untag_all : all VLANs are untagged.

Introduction of Port Types

Below is a detailed description of each port type, including Unaware, C-port, S-port, and S-custom-port.

	Ingress action	Egress action
Unaware The function of Unaware can be used for 802.1QinQ (double tag).	When the port receives untagged frames, an untagged frame obtains a tag (based on PVID) and is forwarded. When the port receives tagged frames: 1. If the tagged frame contains a TPID of 0x8100, it will become a double-tag frame and will be forwarded. 2. If the TPID of tagged frame is not 0x8100 (ex. 0x88A8), it will be discarded.	The TPID of a frame transmitted by Unaware port will be set to 0x8100. The final status of the frame after egressing will also be affected by the Egress Rule.
C-port	When the port receives untagged frames, an untagged frame obtains a tag (based on PVID) and is forwarded. When the port receives tagged frames: 1. If the tagged frame contains a TPID of 0x8100, it will be forwarded. 2. If the TPID of tagged frame is not 0x8100 (ex. 0x88A8), it will be discarded.	The TPID of a frame transmitted by C-port will be set to 0x8100.
S-port	When the port receives untagged frames, an untagged frame obtains a tag (based on PVID) and is forwarded. When the port receives tagged frames: 1. If the tagged frame contains a TPID of 0x8100, it will be forwarded.	The TPID of a frame transmitted by S-port will be set to 0x88A8.

	2. If the TPID of tagged frame is not 0x88A8 (ex. 0x8100), it will be discarded.	
S-custom-port	<p>When the port receives untagged frames, an untagged frame obtains a tag (based on PVID) and is forwarded.</p> <p>When the port receives tagged frames:</p> <ol style="list-style-type: none"> 1. If the tagged frame contains a TPID of 0x8100, it will be forwarded. 2. If the TPID of tagged frame is not 0x88A8 (ex. 0x8100), it will be discarded. 	<p>The TPID of a frame transmitted by S-custom-port will be set to a self-customized value, which can be set by the user via Ethertype for Custom S-ports.</p>

Below are the illustrations of different port types:

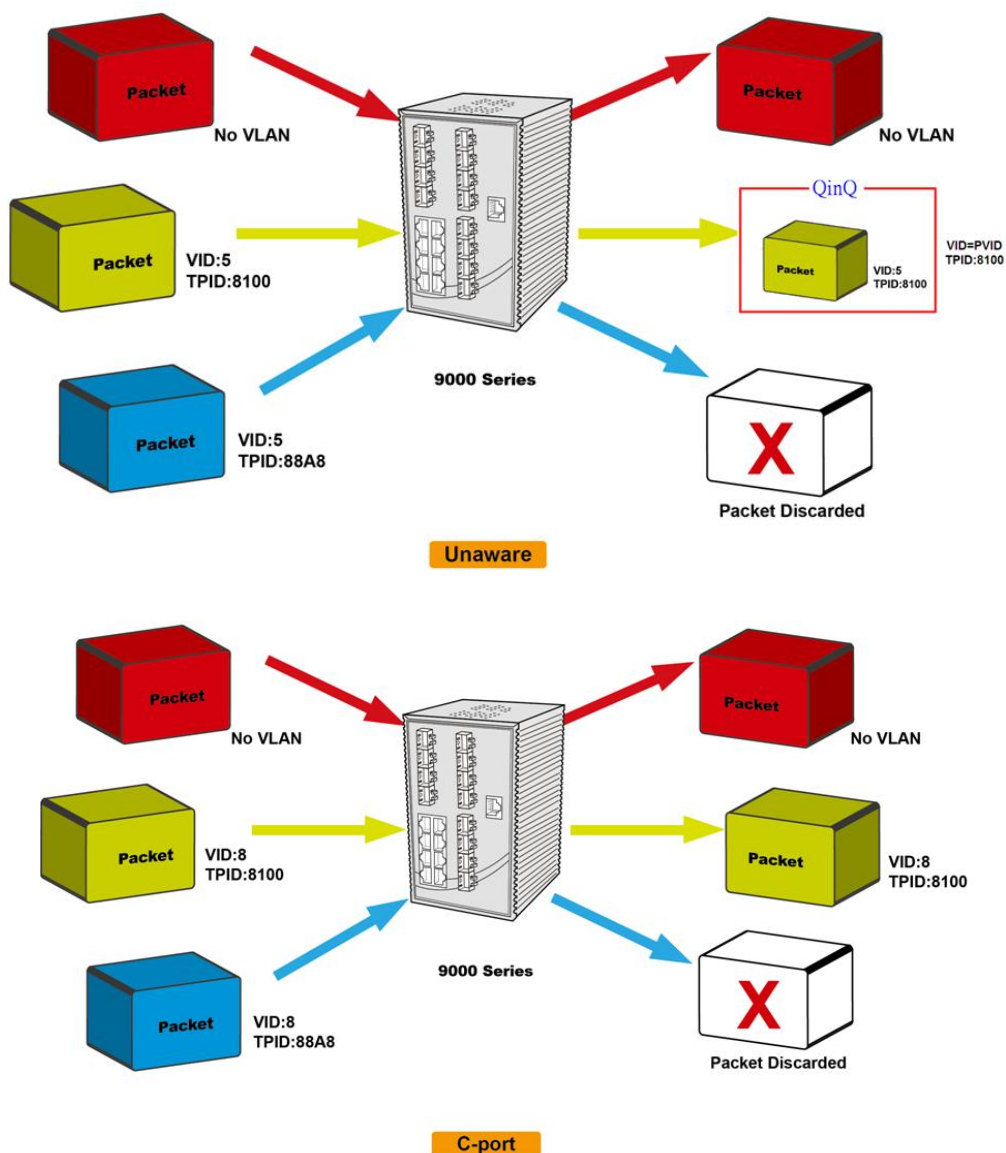

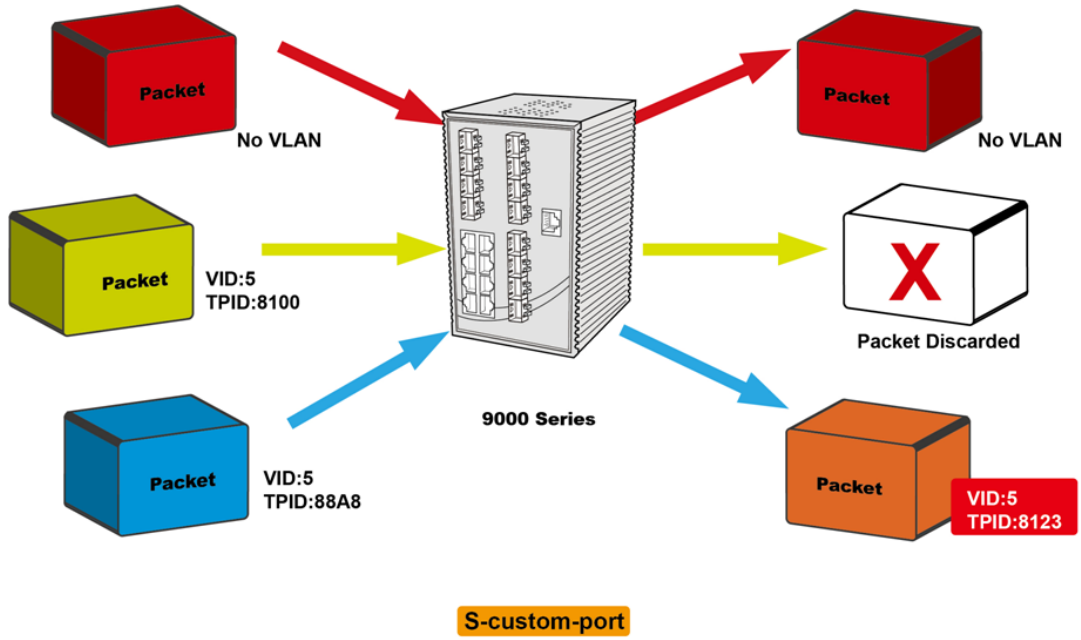
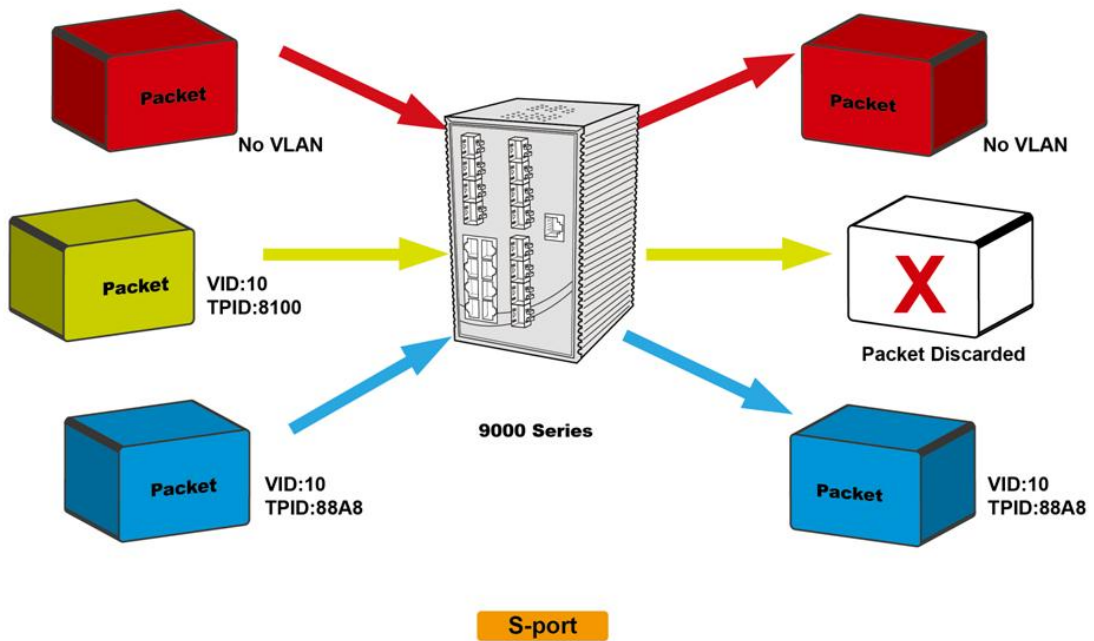

S-custom-port is used for user defined TPID .While Ethertype for Custom S-ports is configured to 8123 , outgoing packet will bring with TPID 8123 tag .

Examples of VLAN Settings

VLAN Access Mode:

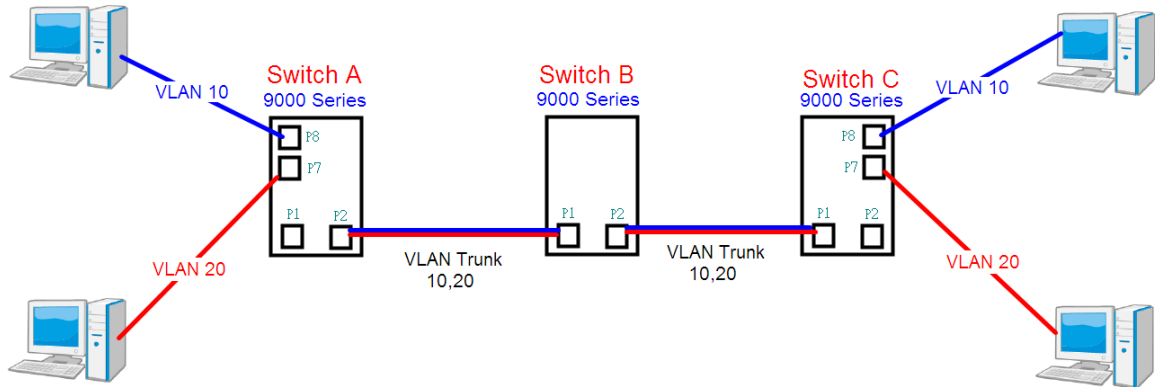

Switch A,

Port 7 is VLAN Access mode = Untagged 20

Port 8 is VLAN Access mode = Untagged 10

Below are the switch settings.

- Open all
- System Information
- Front Panel
- Basic Setting
- DHCP Server/Relay
- Port Setting
- Redundancy
- VLAN
 - VLAN Membership
 - Ports
 - Private VLAN
- SNMP
- Traffic Prioritization
- Multicast
- Security
- Warning
- Monitor and Diag
- Synchronization
- PoE

VLAN Membership Configuration

Refresh | << | >>

Start from VLAN 1 with 20 entries per page.

Delete	VLAN ID	VLAN Name	Port Members													
			1	2	3	4	5	6	7	8	9	10	11	12		
<input type="checkbox"/>	1	default	✓	✓	✓	✓	✓	✓	✓	✓	✓	✓	✓	✓	✓	✓
<input type="checkbox"/>	10	vlan10	✓								✓	✓				
<input type="checkbox"/>	20	vlan20	✓								✓					

Add New VLAN

Save Reset

for port 1 VLAN trunk setting

for port 7 & port 8 VLAN Access

- VLAN
 - VLAN Membership
 - Ports
 - Private VLAN
- SNMP
- Traffic Prioritization
- Multicast
- Security
- Warning
- Monitor and Diag
- Synchronization
- PoE
- Factory Default
- System Reboot

Port	Port Type	Ingress Filtering	Frame Type	Mode	ID	Px Tag
*	<>	<input type="checkbox"/>	<>	<>	1	<>
1	C-port	<input type="checkbox"/>	Tagged	Specific	1	Tag_all
2	Unaware	<input type="checkbox"/>	All	None	1	Untag_pvid
3	Unaware	<input type="checkbox"/>	All	Specific	1	Untag_pvid
4	Unaware	<input type="checkbox"/>	All	Specific	1	Untag_pvid
5	Unaware	<input type="checkbox"/>	All	Specific	1	Untag_pvid
6	Unaware	<input type="checkbox"/>	Untagged	Specific	10	Untag_pvid
7	Unaware	<input type="checkbox"/>	Untagged	Specific	20	Untag_pvid
8	Unaware	<input type="checkbox"/>	Untagged	Specific	30	Untag_pvid
9	Unaware	<input type="checkbox"/>	All	Specific	1	Untag_pvid
10	Unaware	<input type="checkbox"/>	All	Specific	1	Untag_pvid
11	Unaware	<input type="checkbox"/>	All	Specific	1	Untag_pvid

VLAN 1Q Trunk Mode:

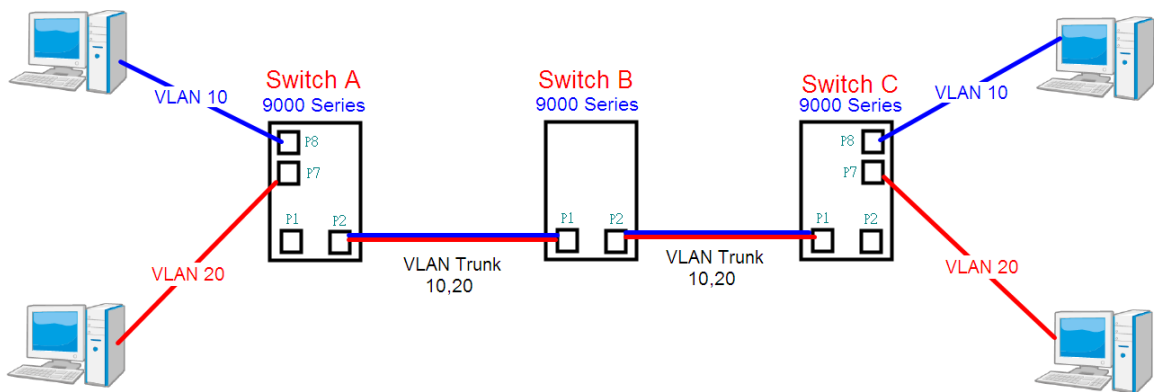

Switch B,

Port 1 = VLAN 1Qtrunk mode = tagged 10, 20

Port 2 = VLAN 1Qtrunk mode = tagged 10, 20

Below are the switch settings.

VLAN Membership Configuration

Refresh | << | >>

Start from VLAN 1 with 20 entries per page.

Delete	VLAN ID	VLAN Name	Port Members											
			1	2	3	4	5	6	7	8	9	10	11	12
<input type="checkbox"/>	1	default	<input checked="" type="checkbox"/>	<input checked="" type="checkbox"/>	<input checked="" type="checkbox"/>	<input checked="" type="checkbox"/>	<input checked="" type="checkbox"/>	<input checked="" type="checkbox"/>	<input checked="" type="checkbox"/>	<input checked="" type="checkbox"/>	<input checked="" type="checkbox"/>	<input checked="" type="checkbox"/>	<input checked="" type="checkbox"/>	<input checked="" type="checkbox"/>
<input type="checkbox"/>	10	VLAN10	<input checked="" type="checkbox"/>	<input checked="" type="checkbox"/>	<input type="checkbox"/>	<input type="checkbox"/>	<input type="checkbox"/>	<input type="checkbox"/>	<input type="checkbox"/>	<input type="checkbox"/>	<input type="checkbox"/>	<input type="checkbox"/>	<input type="checkbox"/>	<input type="checkbox"/>
<input type="checkbox"/>	20	VLAN20	<input checked="" type="checkbox"/>	<input checked="" type="checkbox"/>	<input type="checkbox"/>	<input type="checkbox"/>	<input type="checkbox"/>	<input type="checkbox"/>	<input type="checkbox"/>	<input type="checkbox"/>	<input type="checkbox"/>	<input type="checkbox"/>	<input type="checkbox"/>	<input type="checkbox"/>

Add New VLAN

Save Reset

Auto-refresh Refresh

Ethertype for Custom S-ports 0x88A8

VLAN Port Configuration

Port	Port Type	Ingress Filtering	Frame Type	Port VLAN		Tx Tag
				Mode	ID	
*	<>	<input type="checkbox"/>	<>	<>	1	<>
1	C-port	<input type="checkbox"/>	Tagged	Specific	1	Tag_all
2	C-port	<input type="checkbox"/>	Tagged	Specific	1	Tag_all
3	Unaware	<input type="checkbox"/>	All	Specific	1	Untag_pvid
4	Unaware	<input type="checkbox"/>	All	Specific	1	Untag_pvid
5	Unaware	<input type="checkbox"/>	All	Specific	1	Untag_pvid
6	Unaware	<input type="checkbox"/>	All	Specific	1	Untag_pvid
7	Unaware	<input type="checkbox"/>	All	Specific	1	Untag_pvid
8	Unaware	<input type="checkbox"/>	All	Specific	1	Untag_pvid
9	Unaware	<input type="checkbox"/>	All	Specific	1	Untag_pvid
10	Unaware	<input type="checkbox"/>	All	Specific	1	Untag_pvid
11	Unaware	<input type="checkbox"/>	All	Specific	1	Untag_pvid
12	Unaware	<input type="checkbox"/>	All	Specific	1	Untag_pvid

Save Reset

VLAN Hybrid Mode:

Port 1 VLAN Hybrid mode = untagged 10
 Tagged 10, 20

Below are the switch settings.

VLAN Membership Configuration

Refresh | << | >>

Start from VLAN 1 with 20 entries per page.

Delete	VLAN ID	VLAN Name	Port Members												
			1	2	3	4	5	6	7	8	9	10	11	12	
<input type="checkbox"/>	1	default	<input checked="" type="checkbox"/>	<input checked="" type="checkbox"/>	<input checked="" type="checkbox"/>	<input checked="" type="checkbox"/>	<input checked="" type="checkbox"/>	<input checked="" type="checkbox"/>	<input checked="" type="checkbox"/>	<input checked="" type="checkbox"/>	<input checked="" type="checkbox"/>	<input checked="" type="checkbox"/>	<input checked="" type="checkbox"/>	<input checked="" type="checkbox"/>	<input checked="" type="checkbox"/>
<input type="checkbox"/>	10	vlan10	<input checked="" type="checkbox"/>	<input type="checkbox"/>	<input type="checkbox"/>	<input type="checkbox"/>	<input type="checkbox"/>	<input type="checkbox"/>	<input type="checkbox"/>	<input type="checkbox"/>	<input type="checkbox"/>	<input type="checkbox"/>	<input type="checkbox"/>	<input type="checkbox"/>	<input type="checkbox"/>
<input type="checkbox"/>	20	vlan20	<input checked="" type="checkbox"/>	<input type="checkbox"/>	<input type="checkbox"/>	<input type="checkbox"/>	<input type="checkbox"/>	<input type="checkbox"/>	<input type="checkbox"/>	<input type="checkbox"/>	<input type="checkbox"/>	<input type="checkbox"/>	<input type="checkbox"/>	<input type="checkbox"/>	<input type="checkbox"/>

Add New VLAN

Save Reset

Auto-refresh Refresh

Ethertype for Custom S-ports 0x88A8

VLAN Port Configuration

Port	Port Type	Ingress Filtering	Frame Type	Port VLAN		Tx Tag
				Mode	ID	
*	<>	<input type="checkbox"/>	<>	<>	1	<>
1	C-port	<input type="checkbox"/>	All	Specific	10	Untag_all
2	Unaware	<input type="checkbox"/>	All	None	1	Untag_pvid
3	Unaware	<input type="checkbox"/>	All	Specific	1	Untag_pvid
4	Unaware	<input type="checkbox"/>	All	Specific	1	Untag_pvid
5	Unaware	<input type="checkbox"/>	All	Specific	1	Untag_pvid
6	Unaware	<input type="checkbox"/>	All	Specific	1	Untag_pvid
7	Unaware	<input type="checkbox"/>	All	Specific	1	Untag_pvid
8	Unaware	<input type="checkbox"/>	All	Specific	1	Untag_pvid
9	Unaware	<input type="checkbox"/>	All	Specific	1	Untag_pvid
10	Unaware	<input type="checkbox"/>	All	Specific	1	Untag_pvid
11	Unaware	<input type="checkbox"/>	All	Specific	1	Untag_pvid
12	Unaware	<input type="checkbox"/>	All	Specific	1	Untag_pvid

Save Reset

VLAN QinQ Mode:

VLAN QinQ mode is usually adopted when there are unknown VLANs, as shown in the figure below.

VLAN "X" = Unknown VLAN

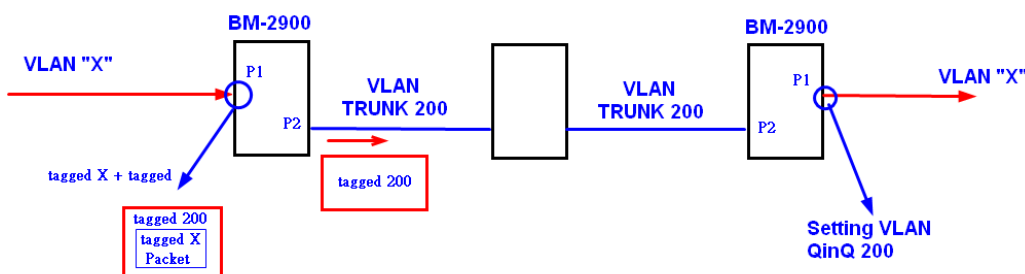

9000 Series Port 1 VLAN Settings:

VLAN Membership Configuration

Refresh | << | >>

Start from VLAN 1 with 20 entries per page.

Delete	VLAN ID	VLAN Name	Port Members											
			1	2	3	4	5	6	7	8	9	10	11	12
<input type="checkbox"/>	1	default	<input checked="" type="checkbox"/>	<input checked="" type="checkbox"/>	<input checked="" type="checkbox"/>	<input checked="" type="checkbox"/>	<input checked="" type="checkbox"/>	<input checked="" type="checkbox"/>	<input checked="" type="checkbox"/>	<input checked="" type="checkbox"/>	<input checked="" type="checkbox"/>	<input checked="" type="checkbox"/>	<input checked="" type="checkbox"/>	<input checked="" type="checkbox"/>
<input type="checkbox"/>	200	QinQ	<input checked="" type="checkbox"/>	<input type="checkbox"/>	<input type="checkbox"/>	<input type="checkbox"/>	<input type="checkbox"/>	<input type="checkbox"/>	<input type="checkbox"/>	<input type="checkbox"/>	<input type="checkbox"/>	<input type="checkbox"/>	<input type="checkbox"/>	<input type="checkbox"/>

Add New VLAN

Save | Reset

Auto-refresh Refresh

Ethertype for Custom S-ports 0x88A8

VLAN Port Configuration

Port	Port Type	Ingress Filtering	Frame Type	Port VLAN		Tx Tag
				Mode	ID	
*	<>	<input type="checkbox"/>	<>	<>	1	<>
1	Unaware	<input type="checkbox"/>	All	Specific	200	Untag_all
2	C-port	<input type="checkbox"/>	Tagged	None	1	Tag_all
3	Unaware	<input type="checkbox"/>	All	Specific	1	Untag_pvid
4	Unaware	<input type="checkbox"/>	All	Specific	1	Untag_pvid
5	Unaware	<input type="checkbox"/>	All	Specific	1	Untag_pvid
6	Unaware	<input type="checkbox"/>	All	Specific	1	Untag_pvid

VLAN ID Settings

When setting the management VLAN, only the same VLAN ID port can be used to control the switch.

9000 Series VLAN Settings:

	Configured	Current
DHCP Client	<input type="checkbox"/>	<input type="button" value="Renew"/>
IP Address	192.168.10.2	192.168.10.2
IP Mask	255.255.255.0	255.255.255.0
IP Router	0.0.0.0	0.0.0.0
VLAN ID	1	1
SNTP Server		

5.4.3 Private VLAN

A private VLAN contains switch ports that can only communicate with a given "uplink". The restricted ports are called private ports. Each private VLAN typically contains many private ports and a single uplink. The switch forwards all frames received on a private port out the uplink port, regardless of VLAN ID or destination MAC address. A port must be a member of both a VLAN and a private VLAN to be able to forward packets. This page allows you to configure private VLAN memberships for the switch. By default, all ports are VLAN unaware and members of VLAN 1 and private VLAN 1.

		Port Members											
Delete	PVLAN ID	1	2	3	4	5	6	7	8	9	10	11	12
<input type="checkbox"/>	1	<input checked="" type="checkbox"/>	<input checked="" type="checkbox"/>	<input checked="" type="checkbox"/>	<input checked="" type="checkbox"/>	<input checked="" type="checkbox"/>	<input checked="" type="checkbox"/>	<input checked="" type="checkbox"/>	<input checked="" type="checkbox"/>	<input checked="" type="checkbox"/>	<input checked="" type="checkbox"/>	<input checked="" type="checkbox"/>	<input checked="" type="checkbox"/>

Label	Description
Delete	Check to delete the entry. It will be deleted during the next save.
Private VLAN ID	Indicates the ID of this particular private VLAN.
MAC Address	The MAC address for the entry.
Port Members	A row of check boxes for each port is displayed for each private VLAN ID. You can check the box to include a port in a private

	VLAN. To remove or exclude the port from the private VLAN, make sure the box is unchecked. By default, no ports are members, and all boxes are unchecked.
Adding a New Static Entry	<p>Click Add new Private VLAN to add a new private VLAN ID. An empty row is added to the table, and the private VLAN can be configured as needed. The allowed range for a private VLAN ID is the same as the switch port number range. Any values outside this range are not accepted, and a warning message appears. Click OK to discard the incorrect entry, or click Cancel to return to the editing and make a correction.</p> <p>The private VLAN is enabled when you click Save.</p> <p>The Delete button can be used to undo the addition of new private VLANs.</p>

A private VLAN is defined as a pairing of a primary VLAN with a secondary VLAN. A promiscuous port is a port that can communicate with all other private VLAN port types via the primary VLAN and any associated secondary VLANs, whereas isolated ports can communicate only with a promiscuous port.

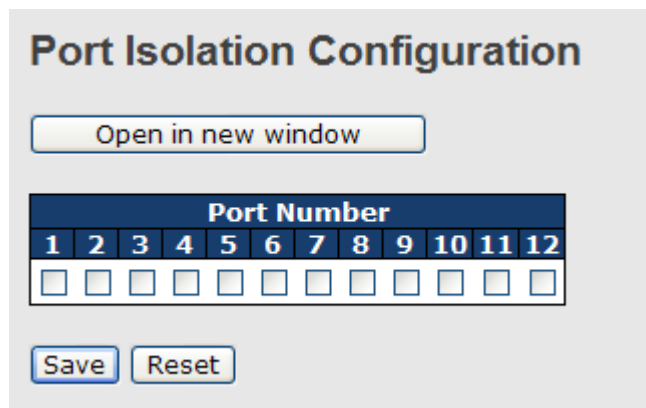

Label	Description
Port Members	<p>A check box is provided for each port of a private VLAN.</p> <p>When checked, port isolation is enabled for that port.</p> <p>When unchecked, port isolation is disabled for that port.</p> <p>By default, port isolation is disabled for all ports.</p>

5.5 SNMP

SNMP (Simple Network Management Protocol) is a protocol for managing devices on IP networks. It is mainly used network management systems to monitor the operational status of

networked devices. In an event-triggered situation, traps and notifications will be sent to administrators.

5.5.1 SNMP System Configurations

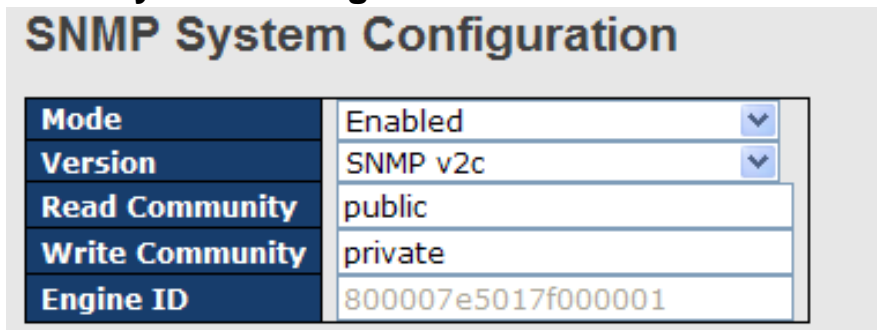

Label	Description
Mode	Indicates existing SNMP mode. Possible modes include: Enabled: enable SNMP mode Disabled: disable SNMP mode
Version	Indicates the supported SNMP version. Possible versions include: SNMP v1: supports SNMP version 1. SNMP v2c: supports SNMP version 2c. SNMP v3: supports SNMP version 3.
Read Community	Indicates the read community string to permit access to SNMP agent. The allowed string length is 0 to 255, and only ASCII characters from 33 to 126 are allowed. The field only suits to SNMPv1 and SNMPv2c. SNMPv3 uses USM for authentication and privacy and the community string will be associated with SNMPv3 community table.
Write Community	Indicates the write community string to permit access to SNMP agent. The allowed string length is 0 to 255, and only ASCII characters from 33 to 126 are allowed. The field only suits to SNMPv1 and SNMPv2c. SNMPv3 uses USM for authentication and privacy and the community string will be associated with SNMPv3 community table.
Engine ID	Indicates the SNMPv3 engine ID. The string must contain an even number between 10 and 64 hexadecimal digits, but all-zeros and all-F's are not allowed. Change of the Engine ID will clear all original local users.

SNMP Trap Configuration

Trap Mode	Disabled <input type="button" value="v"/>
Trap Version	SNMP v1 <input type="button" value="v"/>
Trap Community	public
Trap Destination Address	
Trap Destination IPv6 Address	::
Trap Authentication Failure	Enabled <input type="button" value="v"/>
Trap Link-up and Link-down	Enabled <input type="button" value="v"/>
Trap Inform Mode	Enabled <input type="button" value="v"/>
Trap Inform Timeout (seconds)	1
Trap Inform Retry Times	5

Label	Description
Trap Mode	Indicates existing SNMP trap mode. Possible modes include: Enabled: enable SNMP trap mode Disabled: disable SNMP trap mode
Trap Version	Indicates the supported SNMP trap version. Possible versions include: SNMP v1: supports SNMP trap version 1 SNMP v2c: supports SNMP trap version 2c SNMP v3: supports SNMP trap version 3
Trap Community	Indicates the community access string when sending SNMP trap packets. The allowed string length is 0 to 255, and only ASCII characters from 33 to 126 are allowed.
Trap Destination Address	Indicates the SNMP trap destination address
Trap Destination IPv6 Address	Provides the trap destination IPv6 address of this switch. IPv6 address consists of 128 bits represented as eight groups of four hexadecimal digits with a colon separating each field (:). For example, in 'fe80::215:c5ff:fe03:4dc7', the symbol '::' is a special syntax that can be used as a shorthand way of representing multiple 16-bit groups of contiguous zeros; but it can only appear once. It also uses a following legally IPv4 address. For example, ':::192.1.2.34'.
Trap Authentication Failure	Indicates the SNMP entity is permitted to generate authentication failure traps. Possible modes include: Enabled: enable SNMP trap authentication failure

	Disabled: disable SNMP trap authentication failure
Trap Link-up and Link-down	Indicates the SNMP trap link-up and link-down mode. Possible modes include: Enabled: enable SNMP trap link-up and link-down mode Disabled: disable SNMP trap link-up and link-down mode
Trap Inform Mode	Indicates the SNMP trap inform mode. Possible modes include: Enabled: enable SNMP trap inform mode Disabled: disable SNMP trap inform mode
Trap Inform Timeout(seconds)	Configures the SNMP trap inform timeout. The allowed range is 0 to 2147.
Trap Inform Retry Times	Configures the retry times for SNMP trap inform. The allowed range is 0 to 255.

5.5.2 SNMP Community Configurations

You can define access to the SNMP data on your devices by creating one or more SNMP communities. An SNMP community is the group that devices and management stations running SNMP belong to. It helps define where information is sent. A SNMP device or agent may belong to more than one SNMP community. It will not respond to requests from management stations that do not belong to one of its communities. This page allows you to configure SNMPv3 community table. The entry index key is **Community**.

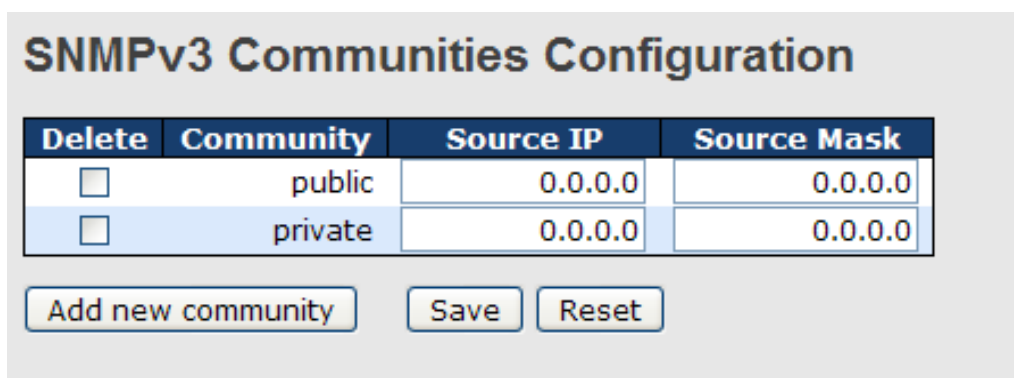

Label	Description
Delete	Check to delete the entry. It will be deleted during the next save.
Community	Indicates the community access string to permit access to SNMPv3 agent. The allowed string length is 1 to 32, and only ASCII characters from 33 to 126 are allowed.
Source IP	Indicates the SNMP source address
Source Mask	Indicates the SNMP source address mask

5.5.3 SNMP User Configurations

Each SNMP user has a specified username, a group to which the user belongs, authentication password, authentication protocol, privacy protocol, and privacy password. When you create a user, you must associate it with an SNMP group. The user then inherits the security model of the group. This page allows you to configure the SNMPv3 user table. The entry index keys are **Engine ID** and **User Name**.

SNMPv3 Users Configuration

Delete	Engine ID	User Name	Security Level	Authentication Protocol	Authentication Password	Privacy Protocol	Privacy Password
<input type="checkbox"/>	800007e5017f000001	default_user	NoAuth, NoPriv	None	None	None	None

Label	Description
Delete	Check to delete the entry. It will be deleted during the next save.
Engine ID	An octet string identifying the engine ID that this entry should belong to. The string must contain an even number between 10 and 64 hexadecimal digits, but all-zeros and all-'F's are not allowed. The SNMPv3 architecture uses User-based Security Model (USM) for message security and View-based Access Control Model (VACM) for access control. For the USM entry, the usmUserEngineID and usmUserName are the entry keys. In a simple agent, usmUserEngineID is always that agent's own snmpEngineID value. The value can also take the value of the snmpEngineID of a remote SNMP engine with which this user can communicate. In other words, if user engine ID is the same as system engine ID, then it is local user; otherwise it's remote user.
User Name	A string identifying the user name that this entry should belong to. The allowed string length is 1 to 32, and only ASCII characters from 33 to 126 are allowed.
Security Level	Indicates the security model that this entry should belong to. Possible security models include: NoAuth, NoPriv: no authentication and none privacy Auth, NoPriv: Authentication and no privacy Auth, Priv: Authentication and privacy The value of security level cannot be modified if the entry already exists, which means the value must be set correctly at the time of entry creation.

Authentication Protocol	<p>Indicates the authentication protocol that this entry should belong to. Possible authentication protocols include:</p> <p>None: no authentication protocol</p> <p>MD5: an optional flag to indicate that this user is using MD5 authentication protocol</p> <p>SHA: an optional flag to indicate that this user is using SHA authentication protocol</p> <p>The value of security level cannot be modified if the entry already exists, which means the value must be set correctly at the time of entry creation.</p>
Authentication Password	<p>A string identifying the authentication pass phrase. For MD5 authentication protocol, the allowed string length is 8 to 32. For SHA authentication protocol, the allowed string length is 8 to 40. Only ASCII characters from 33 to 126 are allowed.</p>
Privacy Protocol	<p>Indicates the privacy protocol that this entry should belong to. Possible privacy protocols include:</p> <p>None: no privacy protocol</p> <p>DES: an optional flag to indicate that this user is using DES authentication protocol</p>
Privacy Password	<p>A string identifying the privacy pass phrase. The allowed string length is 8 to 32, and only ASCII characters from 33 to 126 are allowed.</p>

5.5.4 SNMP Group Configurations

An SNMP group is an access control policy for you to add users. Each SNMP group is configured with a security model, and is associated with an SNMP view. A user within an SNMP group should match the security model of the SNMP group. These parameters specify what type of authentication and privacy a user within an SNMP group uses. Each SNMP group name and security model pair must be unique. This page allows you to configure the SNMPv3 group table. The entry index keys are **Security Model** and **Security Name**.

SNMPv3 Groups Configuration

Delete	Security Model	Security Name	Group Name
<input type="checkbox"/>	v1	public	default_ro_group
<input type="checkbox"/>	v1	private	default_rw_group
<input type="checkbox"/>	v2c	public	default_ro_group
<input type="checkbox"/>	v2c	private	default_rw_group
<input type="checkbox"/>	usm	default_user	default_rw_group

Label	Description
Delete	Check to delete the entry. It will be deleted during the next save.
Security Model	Indicates the security model that this entry should belong to. Possible security models included: v1 : Reserved for SNMPv1. v2c : Reserved for SNMPv2c. usm : User-based Security Model (USM).
Security Name	A string identifying the security name that this entry should belong to. The allowed string length is 1 to 32, and only ASCII characters from 33 to 126 are allowed.
Group Name	A string identifying the group name that this entry should belong to. The allowed string length is 1 to 32, and only ASCII characters from 33 to 126 are allowed.

5.5.5 SNMP View Configurations

The SNMP v3 View table specifies the MIB object access requirements for each View Name. You can specify specific areas of the MIB that can be accessed or denied based on the entries or create and delete entries in the View table in this page. The entry index keys are **View Name** and **OID Subtree**.

SNMPv3 Views Configuration

Delete	View Name	View Type	OID Subtree
<input type="checkbox"/>	default_view	included <input type="button" value="v"/>	.1

Label	Description
Delete	Check to delete the entry. It will be deleted during the next save.
View Name	A string identifying the view name that this entry should belong to. The allowed string length is 1 to 32, and only ASCII characters from 33 to 126 are allowed.
View Type	<p>Indicates the view type that this entry should belong to. Possible view types include:</p> <p>Included: an optional flag to indicate that this view subtree should be included.</p> <p>Excluded: An optional flag to indicate that this view subtree should be excluded.</p> <p>Generally, if an entry's view type is Excluded, it should exist another entry whose view type is Included, and its OID subtree oversteps the Excluded entry.</p>
OID Subtree	The OID defining the root of the subtree to add to the named view. The allowed OID length is 1 to 128. The allowed string content is digital number or asterisk (*).

5.5.6 SNMP Access Configurations

This page allows you to configure SNMPv3 access table. The entry index keys are **Group Name**, **Security Model**, and **Security Level**.

SNMPv3 Accesses Configuration

Delete	Group Name	Security Model	Security Level	Read View Name	Write View Name
<input type="checkbox"/>	default_ro_group	any	NoAuth, NoPriv	default_view	None
<input type="checkbox"/>	default_rw_group	any	NoAuth, NoPriv	default_view	default_view

Label	Description
Delete	Check to delete the entry. It will be deleted during the next save.
Group Name	A string identifying the group name that this entry should belong to. The allowed string length is 1 to 32, and only ASCII characters from 33 to 126 are allowed.
Security Model	<p>Indicates the security model that this entry should belong to. Possible security models include:</p> <p>any: Accepted any security model (v1 v2c usm).</p> <p>v1: Reserved for SNMPv1.</p> <p>v2c: Reserved for SNMPv2c.</p>

	usm: User-based Security Model (USM).
Security Level	Indicates the security model that this entry should belong to. Possible security models include: NoAuth, NoPriv: no authentication and no privacy Auth, NoPriv: Authentication and no privacy Auth, Priv: Authentication and privacy
Read View Name	The name of the MIB view defining the MIB objects for which this request may request the current values. The allowed string length is 1 to 32, and only ASCII characters from 33 to 126 are allowed.
Write View Name	The name of the MIB view defining the MIB objects for which this request may potentially SET new values. The allowed string length is 1 to 32, and only ASCII characters from 33 to 126 are allowed.

5.6 Traffic Prioritization

5.6.1 Storm Control

A LAN storm occurs when packets flood the LAN, creating excessive traffic and degrading network performance. Errors in the protocol-stack implementation, mistakes in network configuration, or users issuing a denial-of-service attack can cause a storm. Storm control prevents traffic on a LAN from being disrupted by a broadcast, multicast, or unicast storm on a port. In this page, you can specify the rate at which packets are received for unicast, multicast, and broadcast traffic. The unit of the rate can be either pps (packets per second) or kpps (kilopackets per second).

Note: frames sent to the CPU of the switch are always limited to approximately 4 kpps. For example, broadcasts in the management VLAN are limited to this rate. The management VLAN is configured on the IP setup page.

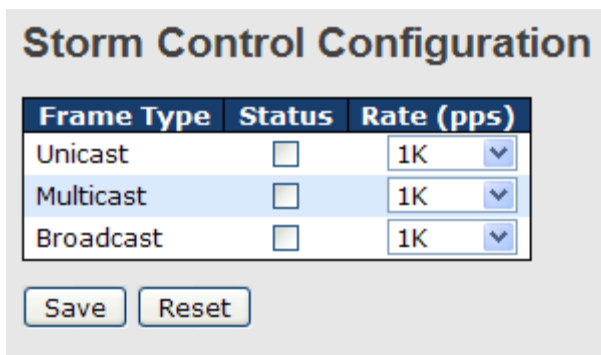

Label	Description
Frame Type	Frame types supported by the Storm Control function, including

	Unicast, Multicast, and Broadcast.
Status	Enables or disables the given frame type
Rate	The rate is packet per second (pps), configure the rate as 1K, 2K, 4K, 8K, 16K, 32K, 64K, 128K, 256K, 512K, or 1024K. The 1 kpps is actually 1002.1 pps.

5.6.2 Port Classification

QoS (Quality of Service) is a method to achieve efficient bandwidth utilization between devices by prioritizing frames according to individual requirements and transmit the frames based on their importance. Frames in higher priority queues receive a bigger slice of bandwidth than those in a lower priority queue.

QoS Ingress Port Classification

Port	QoS class	DP level	PCP	DEI	Tag Class.	DSCP Based
*	<> ▾	<> ▾	<> ▾	<> ▾		<input type="checkbox"/>
1	0 ▾	0 ▾	0 ▾	0 ▾	Disabled	<input type="checkbox"/>
2	0 ▾	0 ▾	0 ▾	0 ▾	Disabled	<input type="checkbox"/>
3	0 ▾	0 ▾	0 ▾	0 ▾	Disabled	<input type="checkbox"/>
4	0 ▾	0 ▾	0 ▾	0 ▾	Disabled	<input type="checkbox"/>
5	0 ▾	0 ▾	0 ▾	0 ▾	Disabled	<input type="checkbox"/>
6	0 ▾	0 ▾	0 ▾	0 ▾	Disabled	<input type="checkbox"/>
7	0 ▾	0 ▾	0 ▾	0 ▾	Disabled	<input type="checkbox"/>
8	0 ▾	0 ▾	0 ▾	0 ▾	Disabled	<input type="checkbox"/>
9	0 ▾	0 ▾	0 ▾	0 ▾	Disabled	<input type="checkbox"/>
10	0 ▾	0 ▾	0 ▾	0 ▾	Disabled	<input type="checkbox"/>
11	0 ▾	0 ▾	0 ▾	0 ▾	Disabled	<input type="checkbox"/>
12	0 ▾	0 ▾	0 ▾	0 ▾	Disabled	<input type="checkbox"/>

Label	Description
Port	The port number for which the configuration below applies
QoS Class	Controls the default QoS class All frames are classified to a QoS class. There is a one to one mapping between QoS class, queue, and priority. A QoS class of 0 (zero) has the lowest priority. If the port is VLAN aware and the frame is tagged, then the frame is classified to a QoS class that is based on the PCP value in the tag as shown below. Otherwise the frame is classified to the

	<p>default QoS class.</p> <p>PCP value: 0 1 2 3 4 5 6 7</p> <p>QoS class: 1 0 2 3 4 5 6 7</p> <p>If the port is VLAN aware, the frame is tagged, and Tag Class is enabled, then the frame is classified to a QoS class that is mapped from the PCP and DEI value in the tag. Otherwise the frame is classified to the default QoS class.</p> <p>The classified QoS class can be overruled by a QCL entry.</p> <p>Note: if the default QoS class has been dynamically changed, then the actual default QoS class is shown in parentheses after the configured default QoS class.</p>
DP level	<p>Controls the default Drop Precedence Level</p> <p>All frames are classified to a DP level.</p> <p>If the port is VLAN aware and the frame is tagged, then the frame is classified to a DP level that is equal to the DEI value in the tag. Otherwise the frame is classified to the default DP level.</p> <p>If the port is VLAN aware, the frame is tagged, and Tag Class is enabled, then the frame is classified to a DP level that is mapped from the PCP and DEI value in the tag. Otherwise the frame is classified to the default DP level.</p> <p>The classified DP level can be overruled by a QCL entry.</p>
PCP	<p>Controls the default PCP value</p> <p>All frames are classified to a PCP value.</p> <p>If the port is VLAN aware and the frame is tagged, then the frame is classified to the PCP value in the tag. Otherwise the frame is classified to the default PCP value.</p>
DEI	<p>Controls the default DEI value</p> <p>All frames are classified to a DEI value.</p> <p>If the port is VLAN aware and the frame is tagged, then the frame is classified to the DEI value in the tag. Otherwise the frame is classified to the default DEI value.</p>
Tag Class	<p>Shows the classification mode for tagged frames on this port</p> <p>Disabled: Use default QoS class and DP level for tagged frames</p> <p>Enabled: Use mapped versions of PCP and DEI for tagged frames</p> <p>Click on the mode to configure the mode and/or mapping</p> <p>Note: this setting has no effect if the port is VLAN unaware.</p>

	Tagged frames received on VLAN-unaware ports are always classified to the default QoS class and DP level.
DSCP Based	Click to enable DSCP-based QoS Ingress Port Classification

5.6.3 Port Tag Remaking

You can set QoS egress queues on a port such as classifying data and marking it according to its priority and the policies. Packets will then travel across the switch's internal paths carrying their assigned QoS tag markers. At the egress port, these markers are read and used to determine which queue each data packet is forwarded to. When the traffic does not conform to the conditions set in a policer command, you can remark the traffic.

QoS Egress Port Tag Remarking

Port	Mode
1	Classified
2	Classified
3	Classified
4	Classified
5	Classified
6	Classified
7	Classified
8	Classified
9	Classified
10	Classified
11	Classified
12	Classified

Label	Description
Port	The switch port number to which the following settings will be applied. Click on the port number to configure tag remarking
Mode	Shows the tag remarking mode for this port Classified: use classified PCP/DEI values Default: use default PCP/DEI values Mapped: use mapped versions of QoS class and DP level

5.6.4 Port DSCP

DSCP (Differentiated Services Code Point) is a measure of QoS. It can classify data packets by using the 6-bit DS field in the IP header so you can manage each traffic class differently and efficiently, thereby achieving optimized use of network bandwidth. DSCP-enabled routers on the network will read the DSCP value of the data packet and put the packet into different queues before transmission, such as high priority and most efficient transmission. With such QoS functions, you can ensure low-latency for critical traffic. This page allows you to configure

DSCP settings for each port.

QoS Port DSCP Configuration

Port	Ingress		Egress
	Translate	Classify	Rewrite
*	<input type="checkbox"/>	<> ▾	<> ▾
1	<input type="checkbox"/>	Disable ▾	Disable ▾
2	<input type="checkbox"/>	Disable ▾	Disable ▾
3	<input type="checkbox"/>	Disable ▾	Disable ▾
4	<input type="checkbox"/>	Disable ▾	Disable ▾
5	<input type="checkbox"/>	Disable ▾	Disable ▾
6	<input type="checkbox"/>	Disable ▾	Disable ▾
7	<input type="checkbox"/>	Disable ▾	Disable ▾
8	<input type="checkbox"/>	Disable ▾	Disable ▾
9	<input type="checkbox"/>	Disable ▾	Disable ▾
10	<input type="checkbox"/>	Disable ▾	Disable ▾
11	<input type="checkbox"/>	Disable ▾	Disable ▾
12	<input type="checkbox"/>	Disable ▾	Disable ▾

Label	Description
Port	Shows the list of ports for which you can configure DSCP Ingress and Egress settings.
Ingress	<p>In Ingress settings you can change ingress translation and classification settings for individual ports.</p> <p>There are two configuration parameters available in Ingress:</p> <p>Translate: check to enable the function</p> <p>Classify: includes four values</p> <p>Disable: no Ingress DSCP classification</p> <p>DSCP=0: classify if incoming (or translated if enabled) DSCP is 0.</p> <p>Selected: classify only selected DSCP whose classification is enabled as specified in DSCP Translation window for the specific DSCP.</p> <p>All: classify all DSCP</p>
Egress	<p>Port egress rewriting can be one of the following options:</p> <p>Disable: no Egress rewrite</p> <p>Enable: rewrite enabled without remapping</p> <p>Remap DP Unaware: DSCP from the analyzer is remapped and</p>

the frame is remarked with a remapped DSCP value. The remapped DSCP value is always taken from the '**DSCP Translation->Egress Remap DP0**' table.

Remap DP Aware: DSCP from the analyzer is remapped and the frame is remarked with a remapped DSCP value. Depending on the DP level of the frame, the remapped DSCP value is either taken from the '**DSCP Translation->Egress Remap DP0**' table or from the '**DSCP Translation->Egress Remap DP1**' table.

5.6.5 Policing

Policing is a traffic regulation mechanism for limiting the rate of traffic streams, thereby controlling the maximum rate of traffic sent or received on an interface. When the traffic rate exceeds the configured maximum rate, policing drops or remarks the excess traffic. This page allows you to configure Policer for all switch ports.

Port Policing

QoS Ingress Port Policers

Port	Enabled	Rate	Unit	Flow Control
*	<input type="checkbox"/>	500	<> ▾	<input type="checkbox"/>
1	<input type="checkbox"/>	500	kbps ▾	<input type="checkbox"/>
2	<input type="checkbox"/>	500	kbps ▾	<input type="checkbox"/>
3	<input type="checkbox"/>	500	kbps ▾	<input type="checkbox"/>
4	<input type="checkbox"/>	500	kbps ▾	<input type="checkbox"/>
5	<input type="checkbox"/>	500	kbps ▾	<input type="checkbox"/>
6	<input type="checkbox"/>	500	kbps ▾	<input type="checkbox"/>
7	<input type="checkbox"/>	500	kbps ▾	<input type="checkbox"/>
8	<input type="checkbox"/>	500	kbps ▾	<input type="checkbox"/>
9	<input type="checkbox"/>	500	kbps ▾	<input type="checkbox"/>
10	<input type="checkbox"/>	500	kbps ▾	<input type="checkbox"/>
11	<input type="checkbox"/>	500	kbps ▾	<input type="checkbox"/>
12	<input type="checkbox"/>	500	kbps ▾	<input type="checkbox"/>

Save Reset

Label	Description
Port	The port number for which the configuration below applies
Enable	Check to enable the policer for individual switch ports
Rate	Configures the rate of each policer. The default value is 500 . This

	value is restricted to 100 to 1000000 when the Unit is kbps or fps , and is restricted to 1 to 3300 when the Unit is Mbps or kfps .
Unit	Configures the unit of measurement for each policer rate as kbps , Mbps , fps , or kfps . The default value is kbps .
Flow Control	If Flow Control is enabled and the port is in Flow Control mode, then pause frames are sent instead of being discarded.

Queue Policing

QoS Ingress Queue Policers										
Port	Queue 0			Queue 1	Queue 2	Queue 3	Queue 4	Queue 5	Queue 6	Queue 7
	E	Rate	Unit	Enable	Enable	Enable	Enable	Enable	Enable	Enable
*	<input checked="" type="checkbox"/>	500	<>	<input type="checkbox"/>	<input type="checkbox"/>	<input type="checkbox"/>	<input type="checkbox"/>	<input type="checkbox"/>	<input type="checkbox"/>	<input type="checkbox"/>
1	<input checked="" type="checkbox"/>	500	kbps	<input type="checkbox"/>	<input type="checkbox"/>	<input type="checkbox"/>	<input type="checkbox"/>	<input type="checkbox"/>	<input type="checkbox"/>	<input type="checkbox"/>
2	<input checked="" type="checkbox"/>	500	kbps	<input type="checkbox"/>	<input type="checkbox"/>	<input type="checkbox"/>	<input type="checkbox"/>	<input type="checkbox"/>	<input type="checkbox"/>	<input type="checkbox"/>
3	<input checked="" type="checkbox"/>	500	kbps	<input type="checkbox"/>	<input type="checkbox"/>	<input type="checkbox"/>	<input type="checkbox"/>	<input type="checkbox"/>	<input type="checkbox"/>	<input type="checkbox"/>
4	<input checked="" type="checkbox"/>	500	kbps	<input type="checkbox"/>	<input type="checkbox"/>	<input type="checkbox"/>	<input type="checkbox"/>	<input type="checkbox"/>	<input type="checkbox"/>	<input type="checkbox"/>
5	<input checked="" type="checkbox"/>	500	kbps	<input type="checkbox"/>	<input type="checkbox"/>	<input type="checkbox"/>	<input type="checkbox"/>	<input type="checkbox"/>	<input type="checkbox"/>	<input type="checkbox"/>

Label	Description
Port	The port number for which the configuration below applies.
Enable(E)	Check to enable queue policer for individual switch ports
Rate	Configures the rate of each queue policer. The default value is 500 . This value is restricted to 100 to 1000000 when the Unit is kbps , and is restricted to 1 to 3300 when the Unit is Mbps . This field is only shown if at least one of the queue policers is enabled.
Unit	Configures the unit of measurement for each queue policer rate as kbps or Mbps. The default value is kbps . This field is only shown if at least one of the queue policers is enabled.

5.6.7 Scheduling and Shaping

Port scheduling can solve performance degradation during network congestions. The schedulers allow switches to maintain separate queues for packets from each source and prevent specific traffic to use up all bandwidth. This page allows you to configure Scheduler and Shapers for individual ports.

QoS Egress Port Scheduler and Shaper

Strict Priority

Strict Priority uses queues based only priority. When traffic arrives the device, traffic on the

highest priority queue will be transmitted first, followed by traffic on lower priorities. If there is always some content in the highest priority queue, then the other packets in the rest of queues will not be sent until the highest priority queue is empty. The SP algorithm is preferred when the received packets contain high priority data, such as voice and video.

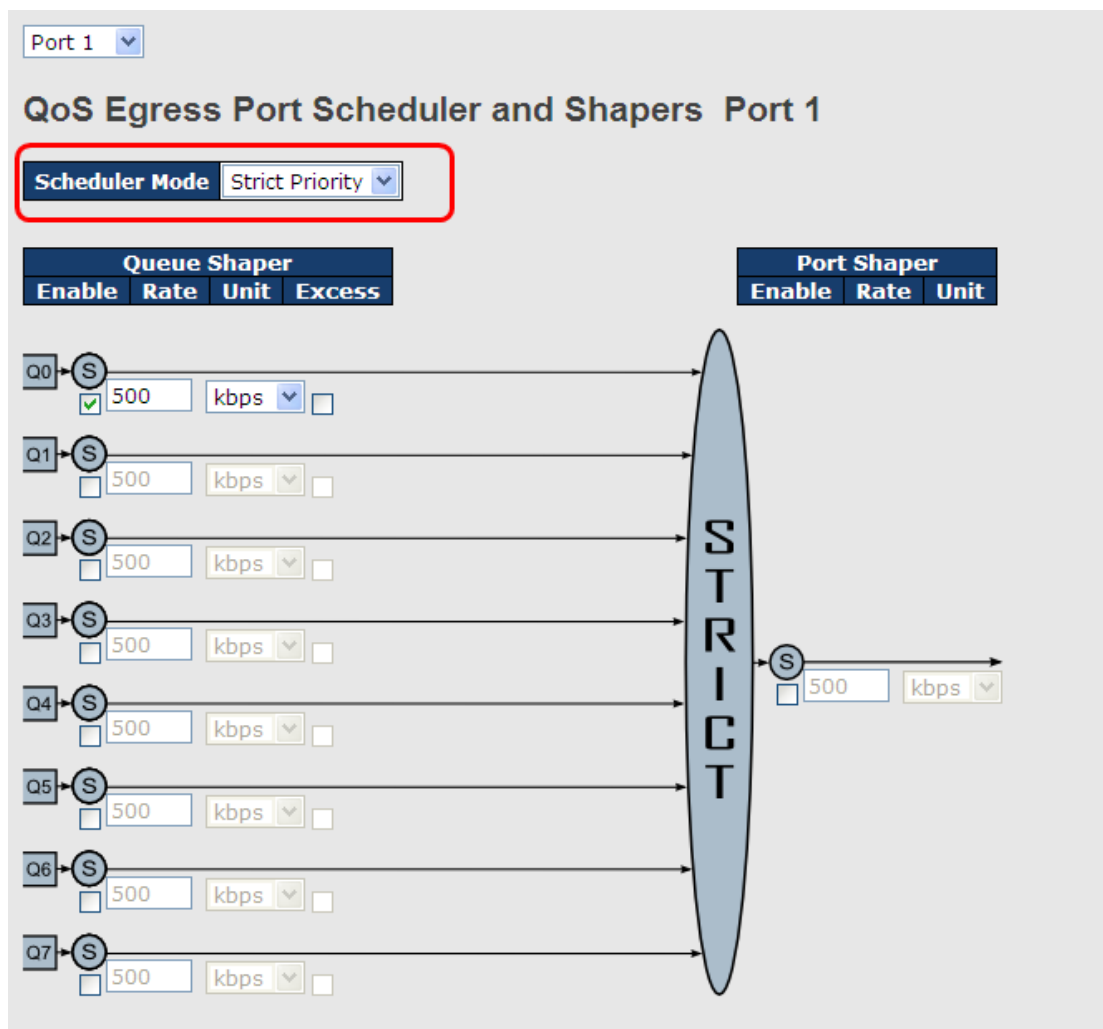

Label	Description
Scheduler Mode	Two scheduling modes are available: Strict Priority or Weighted
Queue Shaper Enable	Check to enable queue shaper for individual switch ports
Queue Shaper Rate	Configures the rate of each queue shaper. The default value is 500 . This value is restricted to 100 to 1000000 when the Unit is kbps ", and it is restricted to 1 to 3300 when the Unit is Mbps .
Queues Shaper Unit	Configures the rate for each queue shaper. The default value is 500 . This value is restricted to 100 to 1000000 when the Unit is kbps , and it is restricted to 1 to 3300 when the Unit is Mbps .

Queue Shaper Excess	Allows the queue to use excess bandwidth
Port Shaper Enable	Check to enable port shaper for individual switch ports
Port Shaper Rate	Configures the rate of each port shaper. The default value is 500 . This value is restricted to 100 to 1000000 when the Unit is kbps , and it is restricted to 1 to 3300 when the Unit is Mbps .
Port Shaper Unit	Configures the unit of measurement for each port shaper rate as kbps or Mbps . The default value is kbps .

Weighted

Weighted scheduling will deliver traffic on a rotating basis. It can guarantee each queue's minimum bandwidth based on their bandwidth weight when there is traffic congestion. Only when a port has more traffic than it can handle will this mode be activated. A queue is given an amount of bandwidth regardless of the incoming traffic on that port. Queue with larger weights will have more guaranteed bandwidth than others with smaller weights.

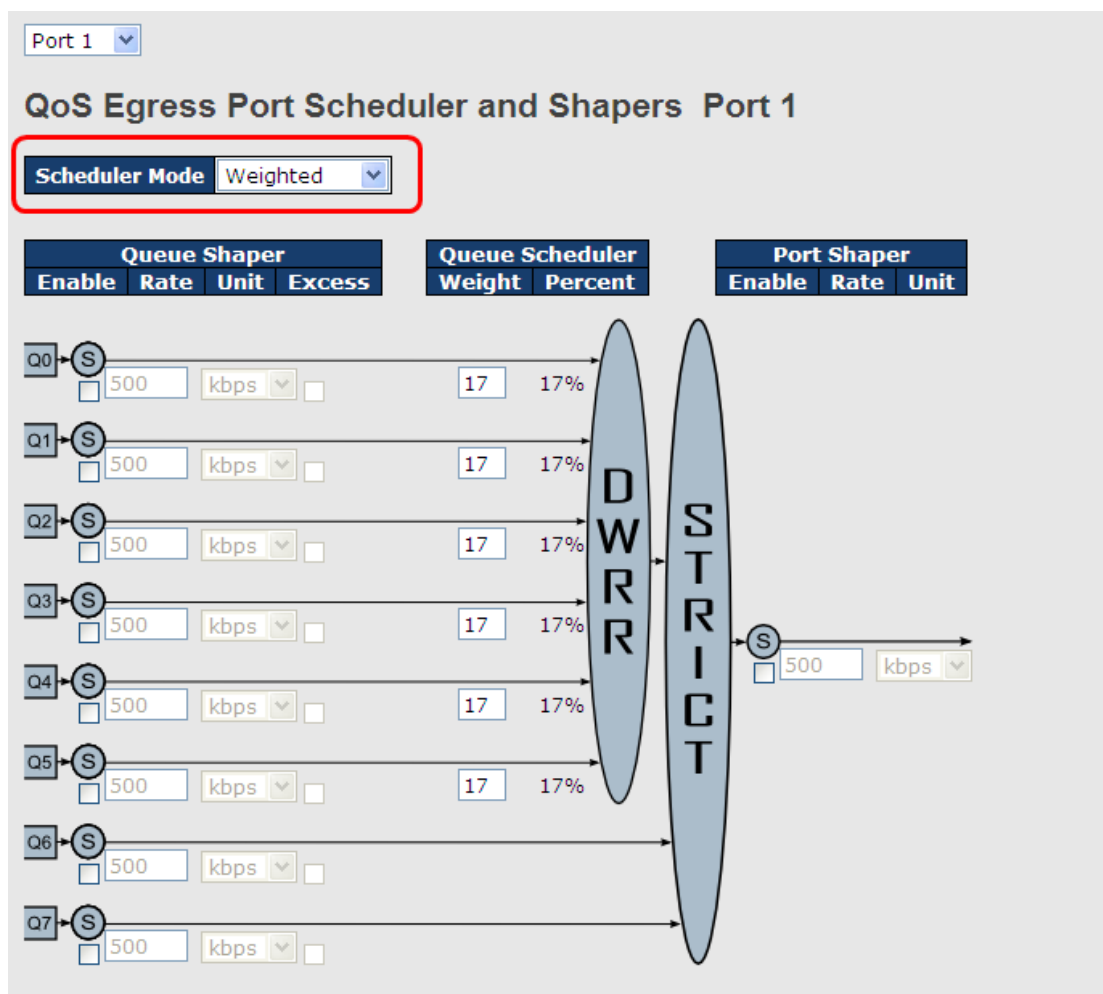

Label	Description
Scheduler Mode	Two scheduling modes are available: Strict Priority or Weighted
Queue Shaper Enable	Check to enable queue shaper for individual switch ports
Queue Shaper Rate	Configures the rate of each queue shaper. The default value is 500 . This value is restricted to 100 to 1000000 when the Unit is kbps , and it is restricted to 1 to 3300 when the Unit is Mbps .
Queues Shaper Unit	Configures the rate of each queue shaper. The default value is 500 . This value is restricted to 100 to 1000000 when the Unit is kbps , and it is restricted to 1 to 3300 when the Unit is Mbps .
Queue Shaper Excess	Allows the queue to use excess bandwidth
Queue Scheduler Weight	Configures the weight of each queue. The default value is 17 . This value is restricted to 1 to 100. This parameter is only shown if Scheduler Mode is set to Weighted .
Queue Scheduler Percent	Shows the weight of the queue in percentage. This parameter is only shown if Scheduler Mode is set to Weighted .
Port Shaper Enable	Check to enable port shaper for individual switch ports
Port Shaper Rate	Configures the rate of each port shaper. The default value is 500 . This value is restricted to 100 to 1000000 when the Unit is kbps , and it is restricted to 1 to 3300 when the Unit is Mbps .
Port Shaper Unit	Configures the unit of measurement for each port shaper rate as kbps or Mbps . The default value is kbps .

5.6.8 Port Scheduler

This page provides an overview of QoS Egress Port Schedulers for all switch ports.

QoS Egress Port Schedulers							
Port	Mode	Weight					
		Q0	Q1	Q2	Q3	Q4	Q5
1	Strict Priority	-	-	-	-	-	-
2	Strict Priority	-	-	-	-	-	-
3	Strict Priority	-	-	-	-	-	-
4	Strict Priority	-	-	-	-	-	-
5	Strict Priority	-	-	-	-	-	-
6	Strict Priority	-	-	-	-	-	-

Label	Description
Port	The switch port number to which the following settings will be

	applied. Click on the port number to configure the schedulers
Mode	Shows the scheduling mode for this port
Qn	Shows the weight for this queue and port

5.6.9 Port Shaping

Port shaping enables you to limit traffic on a port, thereby controlling the amount of traffic passing through the port. With port shaping, you can shape the aggregate traffic through an interface to a rate that is less than the line rate for that interface. When configuring port shaping on an interface, you specify a value indicating the maximum amount of traffic allowable for the interface. This value must be less than the maximum bandwidth for that interface.

QoS Egress Port Shapers

Port	Shapers								Port
	Q0	Q1	Q2	Q3	Q4	Q5	Q6	Q7	
1	disabled	disabled	disabled	disabled	disabled	disabled	disabled	disabled	disabled
2	disabled	disabled	disabled	disabled	disabled	disabled	disabled	disabled	disabled
3	disabled	disabled	disabled	disabled	disabled	disabled	disabled	disabled	disabled
4	disabled	disabled	disabled	disabled	disabled	disabled	disabled	disabled	disabled
5	disabled	disabled	disabled	disabled	disabled	disabled	disabled	disabled	disabled
6	disabled	disabled	disabled	disabled	disabled	disabled	disabled	disabled	disabled

Label	Description
Port	The switch port number to which the following settings will be applied. Click on the port number to configure the shapers
Mode	Shows disabled or actual queue shaper rate - e.g. "800 Mbps"
Q0-Q7	Shows disabled or actual port shaper rate - e.g. "800 Mbps"

5.6.10 DSCP-based QoS

This page allows you to configure DSCP-based QoS Ingress Classification settings for all ports.

DSCP-Based QoS Ingress Classification

DSCP	Trust	QoS Class	DPL
*	<input type="checkbox"/>	<> ▾	<> ▾
0 (BE)	<input type="checkbox"/>	0 ▾	0 ▾
1	<input type="checkbox"/>	0 ▾	0 ▾
2	<input type="checkbox"/>	0 ▾	0 ▾
3	<input type="checkbox"/>	0 ▾	0 ▾
4	<input type="checkbox"/>	0 ▾	0 ▾
5	<input type="checkbox"/>	0 ▾	0 ▾

Label	Description
DSCP	Maximum number of supported DSCP values is 64
Trust	Check to trust a specific DSCP value. Only frames with trusted DSCP values are mapped to a specific QoS class and drop precedence level. Frames with untrusted DSCP values are treated as a non-IP frame.
QoS Class	QoS class value can be any number from 0-7.
DPL	Drop Precedence Level (0-1)

5.6.11 DSCP Translation

This page allows you to configure basic QoS DSCP translation settings for all switches. DSCP translation can apply to **Ingress** or **Egress**.

DSCP Translation				
DSCP	Ingress		Egress	
	Translate	Classify	Remap DP0	Remap DP1
*	<> <input type="checkbox"/>	<input type="checkbox"/>	<> <input type="checkbox"/>	<> <input type="checkbox"/>
0 (BE)	0 (BE) <input type="checkbox"/>	<input type="checkbox"/>	0 (BE) <input type="checkbox"/>	0 (BE) <input type="checkbox"/>
1	1 <input type="checkbox"/>	<input type="checkbox"/>	1 <input type="checkbox"/>	1 <input type="checkbox"/>
2	2 <input type="checkbox"/>	<input type="checkbox"/>	2 <input type="checkbox"/>	2 <input type="checkbox"/>
3	3 <input type="checkbox"/>	<input type="checkbox"/>	3 <input type="checkbox"/>	3 <input type="checkbox"/>
4	4 <input type="checkbox"/>	<input type="checkbox"/>	4 <input type="checkbox"/>	4 <input type="checkbox"/>
5	5 <input type="checkbox"/>	<input type="checkbox"/>	5 <input type="checkbox"/>	5 <input type="checkbox"/>
6	6 <input type="checkbox"/>	<input type="checkbox"/>	6 <input type="checkbox"/>	6 <input type="checkbox"/>
7	7 <input type="checkbox"/>	<input type="checkbox"/>	7 <input type="checkbox"/>	7 <input type="checkbox"/>
8 (CS1)	8 (CS1) <input type="checkbox"/>	<input type="checkbox"/>	8 (CS1) <input type="checkbox"/>	8 (CS1) <input type="checkbox"/>
9	9 <input type="checkbox"/>	<input type="checkbox"/>	9 <input type="checkbox"/>	9 <input type="checkbox"/>

Label	Description
DSCP	Maximum number of supported DSCP values is 64 and valid DSCP value ranges from 0 to 63.
Ingress	Ingress DSCP can be first translated to new DSCP before using the DSCP for QoS class and DPL map. There are two configuration parameters for DSCP Translation - 1. Translate: Enables ingress translation of DSCP values based on the specified classification method. DSCP can be translated to any of (0-63) DSCP values.

	2. Classify: Enable Classification at ingress side as defined in the QoS Port DSCP Configuration table.
Egress	Configurable egress parameters include; Remap DP0: Re-maps DP0 field to selected DSCP value. DP0 indicates a drop precedence with a low priority. You can select the DSCP value from a selected menu to which you want to remap. DSCP value ranges from 0 to 63. Remap DP1: Re-maps DP1 field to selected DSCP value. DP1 indicates a drop precedence with a high priority. You can select the DSCP value from a selected menu to which you want to remap. DSCP value ranges from 0 to 63.

5.6.12 DSCP Classification

This page allows you to configure the mapping of QoS class and Drop Precedence Level to DSCP value.

DSCP Classification

QoS Class	DPL	DSCP
*	*	<> ▼
0	0	0 (BE) ▼
0	1	8 (CS1) ▼
1	0	14 (AF13) ▼
1	1	0 (BE) ▼
2	0	0 (BE) ▼

Label	Description
QoS Class	Actual QoS class
DPL	Actual Drop Precedence Level
DSCP	Select the classified DSCP value (0-63)

5.6.13 QoS Control List

This page shows all the QCE (Quality Control Entries) for a given QCL. You can edit or add new QoS control entries in this page. A QCE consists of several parameters. These parameters vary with the frame type you select.

QCE Configuration

Port Members																			
1	2	3	4	5	6	7	8	9	10	11	12	13	14	15	16	17	18	19	20
✓	✓	✓	✓	✓	✓	✓	✓	✓	✓	✓	✓	✓	✓	✓	✓	✓	✓	✓	✓

Key Parameters

Tag	Tag	Value:	
VID	Specific	Value:	
PCP	2		
DEI	0		
SMAC	Specific	0x	00-00-00
DMAC Type	UC		
Frame Type	Ethernet		

Action Parameters

Class	3
DPL	1
DSCP	28 (AF32)

MAC Parameters

Ether Type	Specific	Value: 0x	FFFF
------------	----------	-----------	------

Label	Description
Port Members	Check to include the port in the QCL entry. By default, all ports are included.
Key Parameters	<p>Key configurations include:</p> <p>Tag: value of tag, can be Any, Untag or Tag.</p> <p>VID: valid value of VLAN ID from 1 to 4095</p> <p>Any: can be a specific value or a range of VIDs.</p> <p>PCP: Priority Code Point, can be specific numbers (0, 1, 2, 3, 4, 5, 6, 7), a range (0-1, 2-3, 4-5, 6-7, 0-3, 4-7) or Any</p> <p>DEI: Drop Eligible Indicator, can be any of values between 0 and 1 or Any</p> <p>SMAC: Source MAC Address, can be 24 MS bits (OUI) or Any</p> <p>DMAC Type: Destination MAC type, can be unicast (UC), multicast (MC), broadcast (BC) or Any</p> <p>Frame Type can be the following values: Any, Ethernet, LLC, SNAP, IPv4, and IPv6</p> <p>Note: all frame types are explained below.</p>
Any	Allow all types of frames
Ethernet	Valid Ethernet values can range from 0x600 to 0xFFFF or Any' but

	<p>excluding 0x800(IPv4) and 0x86DD(IPv6). The default value is Any.</p>
LLC	<p>SSAP Address: valid SSAP (Source Service Access Point) values can range from 0x00 to 0xFF or Any. The default value is Any.</p> <p>DSAP Address: valid DSAP (Destination Service Access Point) values can range from 0x00 to 0xFF or Any. The default value is Any.</p> <p>Control Valid Control: valid values can range from 0x00 to 0xFF or Any. The default value is Any.</p>
SNAP	<p>PID: valid PID (a.k.a ethernet type) values can range from 0x00 to 0xFFFF or Any. The default value is Any.</p>
IPv4	<p>Protocol IP Protocol Number: (0-255, TCP or UDP) or Any</p> <p>Source IP: specific Source IP address in value/mask format or Any. IP and mask are in the format of x.y.z.w where x, y, z, and w are decimal numbers between 0 and 255. When the mask is converted to a 32-bit binary string and read from left to right, all bits following the first zero must also be zero.</p> <p>DSCP (Differentiated Code Point): can be a specific value, a range, or Any. DSCP values are in the range 0-63 including BE, CS1-CS7, EF or AF11-AF43.</p> <p>IP Fragment: Ipv4 frame fragmented options include 'yes', 'no', and 'any'.</p> <p>Sport Source TCP/UDP Port: (0-65535) or Any, specific value or port range applicable for IP protocol UDP/TCP</p> <p>Dport Destination TCP/UDP Port: (0-65535) or Any, specific value or port range applicable for IP protocol UDP/TCP</p>
IPv6	<p>Protocol IP protocol number: (0-255, TCP or UDP) or Any</p> <p>Source IP IPv6 source address: (a.b.c.d) or Any, 32 LS bits</p> <p>DSCP (Differentiated Code Point): can be a specific value, a range, or Any. DSCP values are in the range 0-63 including BE, CS1-CS7, EF or AF11-AF43.</p> <p>Sport Source TCP/UDP port: (0-65535) or Any, specific value or port range applicable for IP protocol UDP/TCP</p> <p>Dport Destination TCP/UDP port: (0-65535) or Any, specific value or port range applicable for IP protocol UDP/TCP</p>
Action Parameters	<p>Class QoS class: (0-7) or Default</p> <p>Valid Drop Precedence Level value can be (0-1) or Default.</p>

	<p>Valid DSCP value can be (0-63, BE, CS1-CS7, EF or AF11-AF43) or Default.</p> <p>Default means that the default classified value is not modified by this QCE.</p>
--	--

5.6.14 QoS Counters

This page shows information on the number of packets sent and received at each queue.

Queuing Counters

Auto-refresh Refresh Clear

Port	Q0		Q1		Q2		Q3		Q4		Q5		Q6		Q7	
	Rx	Tx	Rx	Tx	Rx	Tx	Rx	Tx	Rx	Tx	Rx	Tx	Rx	Tx	Rx	Tx
1	0	0	0	0	0	0	0	0	0	0	0	0	0	0	0	0
2	0	0	0	0	0	0	0	0	0	0	0	0	0	0	0	0
3	0	0	0	0	0	0	0	0	0	0	0	0	0	0	0	0
4	0	0	0	0	0	0	0	0	0	0	0	0	0	0	0	0
5	0	0	0	0	0	0	0	0	0	0	0	0	0	0	0	0
6	0	0	0	0	0	0	0	0	0	0	0	0	0	0	0	0
7	586	0	0	0	0	0	0	0	0	0	0	0	0	0	0	493
8	1307	0	0	0	0	0	0	0	0	0	0	0	0	0	0	2326
9	0	0	0	0	0	0	0	0	0	0	0	0	0	0	0	0

Label	Description
Port	The switch port number to which the following settings will be applied.
Qn	There are 8 QoS queues per port. Q0 is the lowest priority
Rx / Tx	The number of received and transmitted packets per queue

5.6.15 QCL Status

This page shows the QCL status by different QCL users. Each row describes the QCE that is defined. A conflict will occur if a specific QCE is not applied to the hardware due to hardware limitations. The maximum number of QCEs is 256 on each switch.

Combined
Auto-refresh
Resolve Conflict
Refresh

QoS Control List Status

User	QCE#	Frame Type	Port	Action			Conflict
				Class	DPL	DSCP	
No entries							

Label	Description
User	Indicates the QCL user
QCE#	Indicates the index of QCE
Frame Type	<p>Indicates the type of frame to look for incoming frames. Possible frame types are:</p> <p>Any: the QCE will match all frame type.</p> <p>Ethernet: Only Ethernet frames (with Ether Type 0x600-0xFFFF) are allowed.</p> <p>LLC: Only (LLC) frames are allowed.</p> <p>SNAP: Only (SNAP) frames are allowed.</p> <p>IPv4: the QCE will match only IPV4 frames.</p> <p>IPv6: the QCE will match only IPV6 frames.</p>
Port	Indicates the list of ports configured with the QCE.
Action	<p>Indicates the classification action taken on ingress frame if parameters configured are matched with the frame's content.</p> <p>There are three action fields: Class, DPL, and DSCP.</p> <p>Class: Classified QoS; if a frame matches the QCE, it will be put in the queue.</p> <p>DPL: Drop Precedence Level; if a frame matches the QCE, then DP level will set to a value displayed under DPL column.</p> <p>DSCP: if a frame matches the QCE, then DSCP will be classified with the value displayed under DSCP column.</p>
Conflict	<p>Displays the conflict status of QCL entries. As hardware resources are shared by multiple applications, resources required to add a QCE may not be available. In that case, it shows conflict status as Yes, otherwise it is always No. Please note that conflict can be resolved by releasing the hardware resources required to add the QCL entry by pressing Resolve Conflict button.</p>

5.7 Multicast

5.7.1 IGMP Snooping

IGMP (Internet Group Management Protocol) snooping monitors the IGMP traffic between hosts and multicast routers. The switch uses what IGMP snooping learns to forward multicast traffic only to interfaces that are connected to interested receivers. This conserves bandwidth by allowing the switch to send multicast traffic to only those interfaces that are connected to hosts that want to receive the traffic, instead of flooding the traffic to all interfaces in the VLAN.

This page allows you to set up IGMP snooping configurations.

The screenshot shows the 'IGMP Snooping Configuration' interface. It is divided into two main sections: 'Global Configuration' and 'Port Related Configuration'.

Global Configuration:

- Snooping Enabled:**
- Unregistered IPMCv4 Flooding Enabled:**

Port Related Configuration:

Port	Router Port	Fast Leave
*	<input type="checkbox"/>	<input type="checkbox"/>
1	<input type="checkbox"/>	<input type="checkbox"/>
2	<input type="checkbox"/>	<input type="checkbox"/>
3	<input type="checkbox"/>	<input type="checkbox"/>
4	<input type="checkbox"/>	<input type="checkbox"/>
5	<input type="checkbox"/>	<input type="checkbox"/>
6	<input type="checkbox"/>	<input type="checkbox"/>

Label	Description
Snooping Enabled	Check to enable global IGMP snooping
Unregistered IPMCv4 Flooding enabled	Check to enable unregistered IPMC traffic flooding
Router Port	Specifies which ports act as router ports. A router port is a port on the Ethernet switch that leads towards the Layer 3 multicast device or IGMP querier. If an aggregation member port is selected as a router port, the whole aggregation will act as a router port.
Fast Leave	Check to enable fast leave on the port

5.7.2 VLAN Configurations of IGMP Snooping

If a VLAN is not IGMP snooping-enabled, it floods multicast data and control packets to the entire VLAN in hardware. When snooping is enabled, IGMP packets are trapped to the CPU. Data packets are mirrored to the CPU in addition to being VLAN flooded. The CPU then installs hardware resources, so that subsequent data packets can be switched to desired ports in hardware without going to the CPU.

Each page shows up to 99 entries from the VLAN table, depending on the value in the **Entries Per Page** field. By default, the page will show the first 20 entries from the beginning of the

VLAN table. The first displayed will be the one with the lowest VLAN ID found in the VLAN Table.

The **VLAN** field allows the user to select the starting point in the VLAN Table. Clicking **Refresh** will update the displayed table starting from that or the next closest VLAN Table match.

The **>>** button will use the last entry of the currently displayed entry as a basis for the next lookup. When the end is reached, the text **No more entries** is shown in the displayed table. Use the **|<<** button to start over.

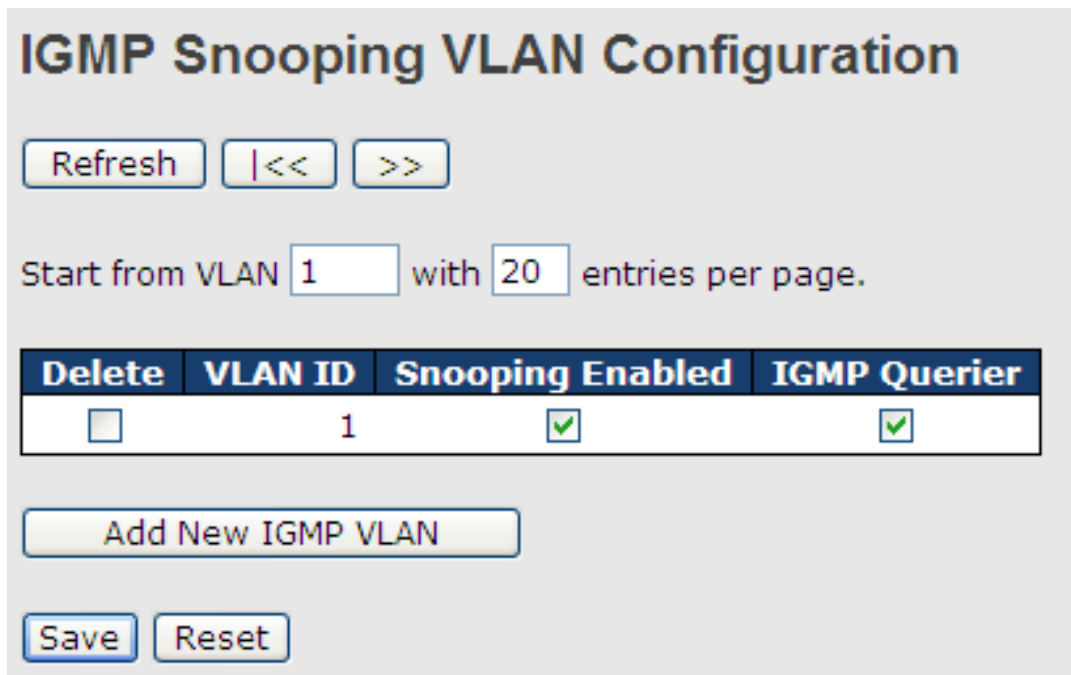

Label	Description
Delete	Check to delete the entry. The designated entry will be deleted during the next save.
VLAN ID	The VLAN ID of the entry
IGMP Snooping Enable	Check to enable IGMP snooping for individual VLAN. Up to 32 VLANs can be selected.
IGMP Querier	Check to enable the IGMP Querier in the VLAN

5.7.3 IGMP Snooping Status

This page provides IGMP snooping status.

Auto-refresh

IGMP Snooping Status

Statistics

VLAN ID	Querier Version	Host Version	Querier Status	Queries Transmitted	Queries Received	V1 Reports Received	V2 Reports Received	V3 Reports Received	V2 Leaves Received
1	v3	v3	DISABLE	0	0	0	0	0	0

Router Port

Port	Status
1	-
2	-
3	-
4	-
5	-
6	-

Label	Description
VLAN ID	The VLAN ID of the entry
Querier Version	Active Querier version
Host Version	Active Host version
Querier Status	Shows the Querier status as ACTIVE or IDLE
Querier Receive	The number of transmitted Querier
V1 Reports Receive	The number of received V1 reports
V2 Reports Receive	The number of received V2 reports
V3 Reports Receive	The number of received V3 reports
V2 Leave Receive	The number of received V2 leave packets
Refresh	Click to refresh the page immediately
Clear	Clear all statistics counters
Auto-refresh	Check to enable an automatic refresh of the page at regular intervals
Port	Switch port number
Status	Indicates whether a specific port is a router port or not

5.7.4 Groups Information of IGMP Snooping

Information about entries in the **IGMP Group Table** is shown in this page. The **IGMP Group Table** is sorted first by VLAN ID, and then by group.

IGMP Snooping Group Information

Auto-refresh Refresh | << >>

Start from VLAN and group address with entries per page.

		Port Members																			
VLAN ID	Groups	1	2	3	4	5	6	7	8	9	10	11	12	13	14	15	16	17	18	19	20
No more entries																					

Label	Description
VLAN ID	The VLAN ID of the group
Groups	The group address of the group displayed
Port Members	Ports under this group

5.8 Security

5.8.1 Remote Control Security Configurations

Remote Control Security allows you to limit remote access to the management interface.

When enabled, requests of the client which is not in the allowed list will be rejected.

Remote Control Security Configuration

Mode

Delete	Port	IP	Web	Telnet	SNMP
<input type="button" value="Delete"/>	<input type="text" value="Any"/>	<input type="text" value="0.0.0.0"/>	<input type="checkbox"/>	<input type="checkbox"/>	<input type="checkbox"/>

Label	Description
Port	Port number of the remote client
IP Address	IP address of the remote client. 0.0.0.0 means "any IP".
Web	Check to enable management via a Web interface

Telnet	Check to enable management via a Telnet interface
SNMP	Check to enable management via a SNMP interface
Delete	Check to delete entries

5.8.2 Device Binding

Device binding is ORing's proprietary technology which binds the IP/MAC address of a device with a specified Ethernet port. If the IP/MAC address of the device connected to the Ethernet port does not conform to the binding requirements, the device will be locked for security concerns. Device Binding also provides security functions via alive checking, streaming check, and DoS/DDoS prevention.

Device Binding

Function State: Enable

Port	Mode	Alive Check		Stream Check		DDOS Prevention		Device	
		Active	Status	Active	Status	Active	Status	IP Address	MAC Address
1	Scan <input type="button" value="v"/>	<input type="checkbox"/>	---	<input type="checkbox"/>	---	<input type="checkbox"/>	---	0.0.0.0	00-00-00-00-
2	Binding <input type="button" value="v"/>	<input type="checkbox"/>	---	<input type="checkbox"/>	---	<input type="checkbox"/>	---	0.0.0.0	00-00-00-00-
3	Shutdown <input type="button" value="v"/>	<input type="checkbox"/>	---	<input type="checkbox"/>	---	<input type="checkbox"/>	---	0.0.0.0	00-00-00-00-
4	--- <input type="button" value="v"/>	<input type="checkbox"/>	---	<input type="checkbox"/>	---	<input type="checkbox"/>	---	0.0.0.0	00-00-00-00-
5	--- <input type="button" value="v"/>	<input type="checkbox"/>	---	<input type="checkbox"/>	---	<input type="checkbox"/>	---	0.0.0.0	00-00-00-00-

Label	Description
Mode	Indicates the device binding operation for each port. Possible modes are: ---: disable Scan : scans IP/MAC automatically, but no binding function Binding : enables binding. Under this mode, any IP/MAC that does not match the entry will not be allowed to access the network. Shutdown : shuts down the port (No Link)
Alive Check Active	Check to enable alive check. When enabled, switch will ping the device continually.
Alive Check Status	Indicates alive check status. Possible statuses are: ---: disable Got Reply : receive ping reply from device, meaning the device is still alive Lost Reply : not receiving ping reply from device, meaning the device might have been dead.
Stream Check Active	Check to enable stream check. When enabled, the switch will detect the stream change (getting low) from the device.

Stream Check Status	Indicates stream check status. Possible statuses are: ---: disable Normal : the stream is normal. Low : the stream is getting low.
DDoS Prevention Acton	Check to enable DDOS prevention. When enabled, the switch will monitor the device against DDOS attacks.
DDoS Prevention Status	Indicates DDOS prevention status. Possible statuses are: ---: disable Analyzing : analyzes packet throughput for initialization Running : analysis completes and ready for next move Attacked : DDOS attacks occur
Device IP Address	Specifies IP address of the device
Device MAC Address	Specifies MAC address of the device

Advanced Configurations

Alias IP Address

This page provides alias IP address configuration. Some devices might have more than one IP addresses. You could specify other IP addresses here.

Port	Alias IP Address
1	0.0.0.0
2	0.0.0.0
3	0.0.0.0
4	0.0.0.0
5	0.0.0.0
6	0.0.0.0
7	0.0.0.0

Label	Description
Alias IP Address	Specifies alias IP address. Keep 0.0.0.0 if the device does not have an alias IP address.

Alive Check

Alive Check monitors the real-time status of the device connected to the port. Alive-checking packets will be sent to the device to probe if the device is running. If the switch receives no response from the device, actions will be taken according to your configurations.

Alive Check

Port	Mode	Action	Status
1	---	---	---
2	---	---	---
3	---	---	---
4	---	---	---
5	---	---	---
6	---	---	---
7	---	---	---
8	---	---	---
9	---	---	---
10	---	---	---
11	---	---	---
12	---	---	---

Note: A dropdown menu is open for Port 2, showing options: Link Change, Only Log it, Shunt Down the Port, and Reboot Device.

Label	Description
Link Change	Disables or enables the port
Only log it	Simply sends logs to the log server
Shunt Down the Port	Disables the port
Reboot Device	Disables or enables PoE power

DDoS Prevention

The switch can monitor ingress packets, and perform actions when DDOS attack occurred on this port. When network traffic from a specific device increases significantly in a short period of time, the switch will lock the IP address of that device to protect the network from attacks. You can configure DDoS prevention on this page to achieve maximum protection.

DDOS Prevention

Port	Mode	Sensibility	Packet Type	Socket Number		Filter	Action	Status
				Low	High			
1	Enabled	Normal	TCP	80	80	Destination	---	Running...
2	---	Normal	TCP	80	80	Destination	---	---
3	---	Normal	TCP	80	80	Destination	---	---
4	---	Normal	TCP	80	80	Destination	---	---
5	---	Normal	TCP	80	80	Destination	---	---
6	---	Normal	TCP	80	80	Destination	---	---
7	---	Normal	TCP	80	80	Destination	---	---
8	---	Normal	TCP	80	80	Destination	---	---
9	---	Normal	TCP	80	80	Destination	---	---
10	---	Normal	TCP	80	80	Destination	---	---
11	---	Normal	TCP	80	80	Destination	---	---

Label	Description
Mode	Enables or disables DDOS prevention of the port
Sensibility	Indicates the level of DDOS detection. Possible levels are: Low: low sensibility Normal: normal sensibility Medium: medium sensibility High: high sensibility
Packet Type	Indicates the types of DDoS attack packets to be monitored. Possible types are: RX Total: all ingress packets RX Unicast: unicast ingress packets RX Multicast: multicast ingress packets RX Broadcast: broadcast ingress packets TCP: TCP ingress packets UDP: UDP ingress packets
Socket Number	If packet type is UDP (or TCP), please specify the socket number here. The socket number can be a range, from low to high. If the socket number is only one, please fill the same number in the low and high fields.
Filter	If packet type is UDP (or TCP), please choose the socket direction (Destination/Source).
Action	Indicates the action to take when DDOS attacks occur. Possible actions are: ---: no action Blocking 1 minute: blocks the forwarding for 1 minute and log the event Blocking 10 minute: blocks the forwarding for 10 minutes and log

	<p>the event</p> <p>Blocking: blocks and logs the event</p> <p>Shunt Down the Port: shuts down the port (No Link) and logs the event</p> <p>Only Log it: simply logs the event</p> <p>Reboot Device: if PoE is supported, the device can be rebooted. The event will be logged.</p>
Status	<p>Indicates the DDOS prevention status. Possible statuses are:</p> <p>---: disables DDOS prevention</p> <p>Analyzing: analyzes packet throughput for initialization</p> <p>Running: analysis completes and ready for next move</p> <p>Attacked: DDOS attacks occur</p>

Device Description

This page allows you to configure device description settings.

Device Description

Port	Device		
	Type	Location Address	Description
1	IP Camera		
2	IP Phone		
3	Access Point		
4	PC		
5	PLC		
6	Network Video Recorder		
7	---		
8	---		
9	---		
10	---		
11	---		
12	---		

Label	Description
Device Type	<p>Indicates device types. Possible types are:</p> <p>---: no specification</p> <p>IP Camera</p> <p>IP Phone</p> <p>Access Point</p>

	PC PLC Network Video Recorder
Location Address	Indicates location information of the device. The information can be used for Google Mapping.
Description	Device descriptions

Stream Check

Stream check monitors the consistency of real-time network traffic from the device bound with the port. When the traffic changes sharply all of a sudden, an alert will be issued. This page allows you to configure stream check settings.

Stream Check

Port	Mode	Action	Status
1	Enabled <input type="button" value="v"/>	Log it <input type="button" value="v"/>	Normal
2	--- <input type="button" value="v"/>	--- <input type="button" value="v"/>	---
3	--- <input type="button" value="v"/>	--- <input type="button" value="v"/>	---
4	--- <input type="button" value="v"/>	--- <input type="button" value="v"/>	---
5	--- <input type="button" value="v"/>	--- <input type="button" value="v"/>	---
6	--- <input type="button" value="v"/>	--- <input type="button" value="v"/>	---
7	--- <input type="button" value="v"/>	--- <input type="button" value="v"/>	---
8	--- <input type="button" value="v"/>	--- <input type="button" value="v"/>	---
9	--- <input type="button" value="v"/>	--- <input type="button" value="v"/>	---
10	--- <input type="button" value="v"/>	--- <input type="button" value="v"/>	---
11	--- <input type="button" value="v"/>	--- <input type="button" value="v"/>	---
12	--- <input type="button" value="v"/>	--- <input type="button" value="v"/>	---

Label	Description
Mode	Enables or disables stream monitoring of the port
Action	Indicates the action to take when the stream gets low. Possible actions are: ---: no action Log it: simply logs the event

5.8.3 ACL

An ACL (Access Control List) is a list of permissions attached to an object. An ACL specifies which users or system processes are authorized to access the objects and what operations are allowed on given objects.

Port Configuration

ACL Ports Configuration							
Refresh		Clear					
Port	Policy ID	Action	Rate Limiter ID	Port Copy	Logging	Shutdown	Counter
1	1	Permit	Disabled	Disabled	Disabled	Disabled	108498
2	1	Permit	Disabled	Disabled	Disabled	Disabled	0
3	1	Permit	Disabled	Disabled	Disabled	Disabled	68732984
4	1	Permit	Disabled	Disabled	Disabled	Disabled	0
5	1	Permit	Disabled	Disabled	Disabled	Disabled	0
6	1	Permit	Disabled	Disabled	Disabled	Disabled	68732984
7	1	Permit	Disabled	Disabled	Disabled	Disabled	0
8	1	Permit	Disabled	Disabled	Disabled	Disabled	0

Label	Description
Port	The switch port number to which the following settings will be applied
Policy ID	Select to apply a policy to the port. The allowed values are 1 to 8. The default value is 1 .
Action	Select to Permit to permit or Deny to deny forwarding. The default value is Permit .
Rate Limiter ID	Select a rate limiter for the port. The allowed values are Disabled or numbers from 1 to 15. The default value is Disabled .
Port Copy	Select which port frames are copied to. The allowed values are Disabled or a specific port number. The default value is Disabled .
Logging	Specifies the logging operation of the port. The allowed values are: Enabled : frames received on the port are stored in the system log Disabled : frames received on the port are not logged The default value is Disabled . Please note that system log memory capacity and logging rate is limited.
Shutdown	Specifies the shutdown operation of this port. The allowed values are: Enabled : if a frame is received on the port, the port will be disabled. Disabled : port shut down is disabled. The default value is Disabled .
Counter	Counts the number of frames that match this ACE.

Rate Limiters

This page allows you to define the rate limits applied to a port.

ACL Rate Limiter Configuration

Rate Limiter ID	Rate (pps)
1	1
2	1
3	1
4	1
5	1
6	1
7	1
8	1
9	1
10	1
11	1
12	1

Label	Description
Rate Limiter ID	The rate limiter ID for the settings contained in the same row.
Rate	The rate unit is packet per second (pps), which can be configured as 1, 2, 4, 8, 16, 32, 64, 128, 256, 512, 1K, 2K, 4K, 8K, 16K, 32K, 64K, 128K, 256K, 512K, or 1024K. The 1 kpps is actually 1002.1 pps.

ACL Control List

An ACE (Access Control Entry) is an element in an access control list (ACL). An ACL can have zero or more ACEs. Each ACE controls or monitors access to an object based on user-defined configurations. Each ACE consists of several parameters which vary with the frame type you have selected.

ACE Configuration

Ingress Port	Port 1	Action	Permit
Frame Type	IPv4	Rate Limiter	Disabled
		Port Copy	Disabled
		Logging	Disabled
		Shutdown	Disabled
		Counter	5197

Label	Description
Ingress Port	Indicates the ingress port to which the ACE will apply.

	<p>Any: the ACE applies to any port</p> <p>Port n: the ACE applies to this port number, where n is the number of the switch port.</p> <p>Policy n: the ACE applies to this policy number, where n can range from 1 to 8.</p>
Frame Type	<p>Indicates the frame type of the ACE. These frame types are mutually exclusive.</p> <p>Any: any frame can match the ACE.</p> <p>Ethernet Type: only Ethernet type frames can match the ACE. The IEEE 802.3 describes the value of length/types should be greater than or equal to 1536 decimal (equal to 0600 hexadecimal).</p> <p>ARP: only ARP frames can match the ACE. Notice the ARP frames will not match the ACE with Ethernet type.</p> <p>IPv4: only IPv4 frames can match the ACE. Notice the IPv4 frames will not match the ACE with Ethernet type.</p>
Action	<p>Specifies the action to take when a frame matches the ACE.</p> <p>Permit: takes action when the frame matches the ACE.</p> <p>Deny: drops the frame matching the ACE.</p>
Rate Limiter	<p>Specifies the rate limiter in number of base units. The allowed range is 1 to 15. Disabled means the rate limiter operation is disabled.</p>
Port Copy	<p>Frames matching the ACE are copied to the port number specified here. The allowed range is the same as the switch port number range. Disabled means the port copy operation is disabled.</p>
Logging	<p>Specifies the logging operation of the ACE. The allowed values are:</p> <p>Enabled: frames matching the ACE are stored in the system log.</p> <p>Disabled: frames matching the ACE are not logged.</p> <p>Please note that system log memory capacity and logging rate is limited.</p>
Shutdown	<p>Specifies the shutdown operation of the ACE. The allowed values are:</p> <p>Enabled: if a frame matches the ACE, the ingress port will be disabled.</p> <p>Disabled: port shutdown is disabled for the ACE.</p>
Counter	<p>Indicates the number of times the ACE matched by a frame.</p>

MAC Parameters

SMAC Filter	Specific ▼
SMAC Value	00-00-00-00-00-0
DMAC Filter	Specific ▼
DMAC Value	00-00-00-00-00-0:

Label	Description
SMAC Filter	<p>(Only displayed when the frame type is Ethernet Type or ARP.) Specifies the source MAC filter for the ACE. Any: no SMAC filter is specified (SMAC filter status is "don't-care"). Specific: if you want to filter a specific source MAC address with the ACE, choose this value. A field for entering an SMAC value appears.</p>
SMAC Value	<p>When Specific is selected for the SMAC filter, you can enter a specific source MAC address. The legal format is "xx-xx-xx-xx-xx-xx". Frames matching the ACE will use this SMAC value.</p>
DMAC Filter	<p>Specifies the destination MAC filter for this ACE Any: no DMAC filter is specified (DMAC filter status is "don't-care"). MC: frame must be multicast. BC: frame must be broadcast. UC: frame must be unicast. Specific: If you want to filter a specific destination MAC address with the ACE, choose this value. A field for entering a DMAC value appears.</p>
DMAC Value	<p>When Specific is selected for the DMAC filter, you can enter a specific destination MAC address. The legal format is "xx-xx-xx-xx-xx-xx". Frames matching the ACE will use this DMAC value.</p>

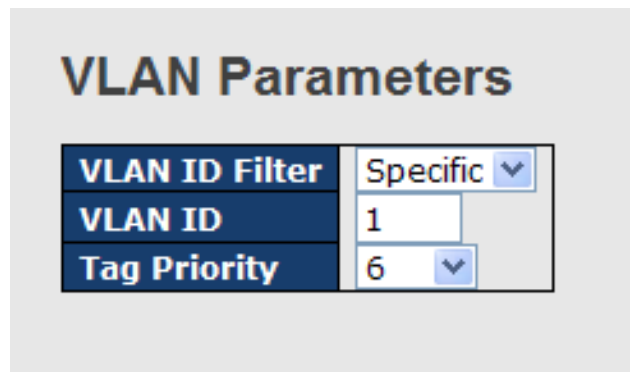

Label	Description
VLAN ID Filter	Specifies the VLAN ID filter for the ACE Any: no VLAN ID filter is specified (VLAN ID filter status is "don't-care"). Specific: if you want to filter a specific VLAN ID with the ACE, choose this value. A field for entering a VLAN ID number appears.
VLAN ID	When Specific is selected for the VLAN ID filter, you can enter a specific VLAN ID number. The allowed range is 1 to 4095. Frames matching the ACE will use this VLAN ID value.
Tag Priority	Specifies the tag priority for the ACE. A frame matching the ACE will use this tag priority. The allowed number range is 0 to 7. Any means that no tag priority is specified (tag priority is "don't-care").

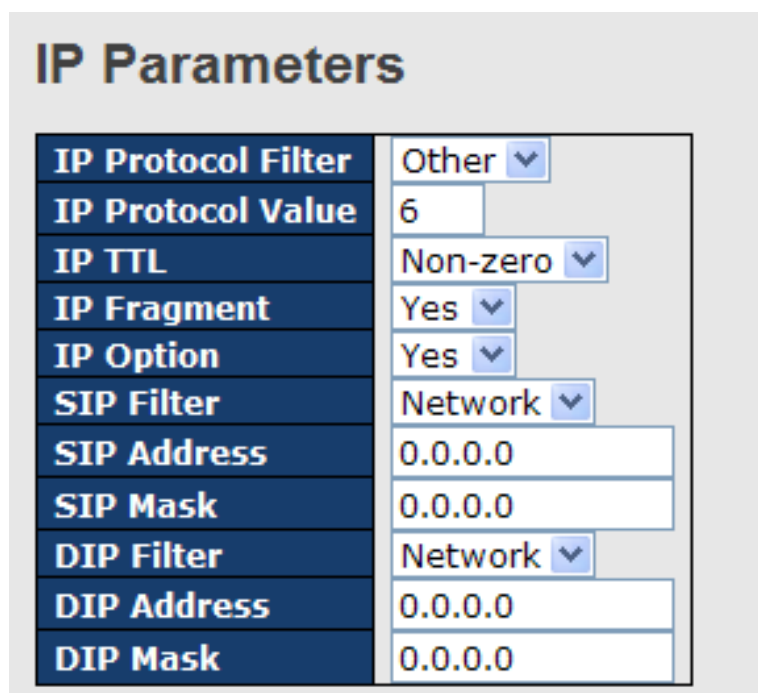

Label	Description
IP Protocol Filter	<p>Specifies the IP protocol filter for the ACE</p> <p>Any: no IP protocol filter is specified ("don't-care").</p> <p>Specific: if you want to filter a specific IP protocol filter with the ACE, choose this value. A field for entering an IP protocol filter appears.</p> <p>ICMP: selects ICMP to filter IPv4 ICMP protocol frames. Extra fields for defining ICMP parameters will appear. For more details of these fields, please refer to the help file.</p> <p>UDP: selects UDP to filter IPv4 UDP protocol frames. Extra fields for defining UDP parameters will appear. For more details of these fields, please refer to the help file.</p> <p>TCP: selects TCP to filter IPv4 TCP protocol frames. Extra fields for defining TCP parameters will appear. For more details of these fields, please refer to the help file.</p>
IP Protocol Value	<p>Specific allows you to enter a specific value. The allowed range is 0 to 255. Frames matching the ACE will use this IP protocol value.</p>
IP TTL	<p>Specifies the time-to-live settings for the ACE</p> <p>Zero: IPv4 frames with a time-to-live value greater than zero must not be able to match this entry.</p> <p>Non-zero: IPv4 frames with a time-to-live field greater than zero must be able to match this entry.</p> <p>Any: any value is allowed ("don't-care").</p>
IP Fragment	<p>Specifies the fragment offset settings for the ACE. This includes settings of More Fragments (MF) bit and Fragment Offset (FRAG OFFSET) for an IPv4 frame.</p> <p>No: IPv4 frames whose MF bit is set or the FRAG OFFSET field is greater than zero must not be able to match this entry.</p> <p>Yes: IPv4 frames whose MF bit is set or the FRAG OFFSET field is greater than zero must be able to match this entry.</p> <p>Any: any value is allowed ("don't-care").</p>
IP Option	<p>Specifies the options flag settings for the ACE</p> <p>No: IPv4 frames whose options flag is set must not be able to match this entry.</p> <p>Yes: IPv4 frames whose options flag is set must be able to match this entry.</p> <p>Any: any value is allowed ("don't-care").</p>
SIP Filter	<p>Specifies the source IP filter for this ACE</p>

	<p>Any: no source IP filter is specified (Source IP filter is "don't-care").</p> <p>Host: source IP filter is set to Host. Specify the source IP address in the SIP Address field that appears.</p> <p>Network: source IP filter is set to Network. Specify the source IP address and source IP mask in the SIP Address and SIP Mask fields that appear.</p>
SIP Address	When Host or Network is selected for the source IP filter, you can enter a specific SIP address in dotted decimal notation.
SIP Mask	When Network is selected for the source IP filter, you can enter a specific SIP mask in dotted decimal notation.
DIP Filter	<p>Specifies the destination IP filter for the ACE</p> <p>Any: no destination IP filter is specified (destination IP filter is "don't-care").</p> <p>Host: destination IP filter is set to Host. Specify the destination IP address in the DIP Address field that appears.</p> <p>Network: destination IP filter is set to Network. Specify the destination IP address and destination IP mask in the DIP Address and DIP Mask fields that appear.</p>
DIP Address	When Host or Network is selected for the destination IP filter, you can enter a specific DIP address in dotted decimal notation.
DIP Mask	When Network is selected for the destination IP filter, you can enter a specific DIP mask in dotted decimal notation.

ARP Parameters

ARP/RARP	Other ▾	ARP SMAC Match	1 ▾
Request/Reply	Request ▾	RARP SMAC Match	1 ▾
Sender IP Filter	Network ▾	IP/Ethernet Length	Any ▾
Sender IP Address	192.168.1.1	IP	0 ▾
Sender IP Mask	255.255.255.0	Ethernet	1 ▾
Target IP Filter	Network ▾		
Target IP Address	192.168.1.254		
Target IP Mask	255.255.255.0		

Label	Description
ARP/RARP	<p>Specifies the available ARP/RARP opcode (OP) flag for the ACE</p> <p>Any: no ARP/RARP OP flag is specified (OP is "don't-care").</p> <p>ARP: frame must have ARP/RARP opcode set to ARP</p>

	<p>RARP: frame must have ARP/RARP opcode set to RARP.</p> <p>Other: frame has unknown ARP/RARP Opcode flag.</p>
Request/Reply	<p>Specifies the available ARP/RARP opcode (OP) flag for the ACE</p> <p>Any: no ARP/RARP OP flag is specified (OP is "don't-care").</p> <p>Request: frame must have ARP Request or RARP Request OP flag set.</p> <p>Reply: frame must have ARP Reply or RARP Reply OP flag.</p>
Sender IP Filter	<p>Specifies the sender IP filter for the ACE</p> <p>Any: no sender IP filter is specified (sender IP filter is "don't-care").</p> <p>Host: sender IP filter is set to Host. Specify the sender IP address in the SIP Address field that appears.</p> <p>Network: sender IP filter is set to Network. Specify the sender IP address and sender IP mask in the SIP Address and SIP Mask fields that appear.</p>
Sender IP Address	<p>When Host or Network is selected for the sender IP filter, you can enter a specific sender IP address in dotted decimal notation.</p>
Sender IP Mask	<p>When Network is selected for the sender IP filter, you can enter a specific sender IP mask in dotted decimal notation.</p>
Target IP Filter	<p>Specifies the target IP filter for the specific ACE</p> <p>Any: no target IP filter is specified (target IP filter is "don't-care").</p> <p>Host: target IP filter is set to Host. Specify the target IP address in the Target IP Address field that appears.</p> <p>Network: target IP filter is set to Network. Specify the target IP address and target IP mask in the Target IP Address and Target IP Mask fields that appear.</p>
Target IP Address	<p>When Host or Network is selected for the target IP filter, you can enter a specific target IP address in dotted decimal notation.</p>
Target IP Mask	<p>When Network is selected for the target IP filter, you can enter a specific target IP mask in dotted decimal notation.</p>
ARP SMAC Match	<p>Specifies whether frames will meet the action according to their sender hardware address field (SHA) settings.</p> <p>0: ARP frames where SHA is not equal to the SMAC address</p> <p>1: ARP frames where SHA is equal to the SMAC address</p> <p>Any: any value is allowed ("don't-care").</p>
RARP SMAC Match	<p>Specifies whether frames will meet the action according to their target hardware address field (THA) settings.</p> <p>0: RARP frames where THA is not equal to the SMAC address</p>

	<p>1: RARP frames where THA is equal to the SMAC address</p> <p>Any: any value is allowed ("don't-care").</p>
IP/Ethernet Length	<p>Specifies whether frames will meet the action according to their ARP/RARP hardware address length (HLN) and protocol address length (PLN) settings.</p> <p>0: ARP/RARP frames where the HLN is equal to Ethernet (0x06) and the (PLN) is equal to IPv4 (0x04) must not match this entry.</p> <p>1: ARP/RARP frames where the HLN is equal to Ethernet (0x06) and the (PLN) is equal to IPv4 (0x04) must match this entry.</p> <p>Any: any value is allowed ("don't-care").</p>
IP	<p>Specifies whether frames will meet the action according to their ARP/RARP hardware address space (HRD) settings.</p> <p>0: ARP/RARP frames where the HLD is equal to Ethernet (1) must not match this entry.</p> <p>1: ARP/RARP frames where the HLD is equal to Ethernet (1) must match this entry.</p> <p>Any: any value is allowed ("don't-care").</p>
Ethernet	<p>Specifies whether frames will meet the action according to their ARP/RARP protocol address space (PRO) settings.</p> <p>0: ARP/RARP frames where the PRO is equal to IP (0x800) must not match this entry.</p> <p>1: ARP/RARP frames where the PRO is equal to IP (0x800) must match this entry.</p> <p>Any: any value is allowed ("don't-care").</p>

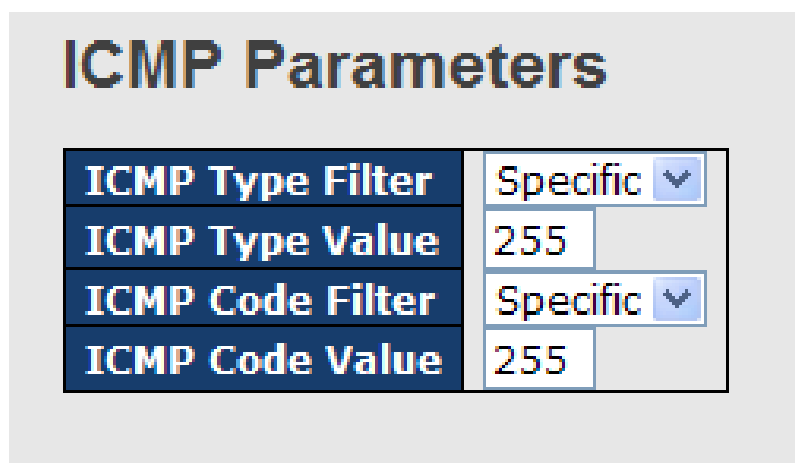

Label	Description
-------	-------------

ICMP Type Filter	<p>Specifies the ICMP filter for the ACE</p> <p>Any: no ICMP filter is specified (ICMP filter status is "don't-care").</p> <p>Specific: if you want to filter a specific ICMP filter with the ACE, you can enter a specific ICMP value. A field for entering an ICMP value appears.</p>
ICMP Type Value	<p>When Specific is selected for the ICMP filter, you can enter a specific ICMP value. The allowed range is 0 to 255. A frame matching the ACE will use this ICMP value.</p>
ICMP Code Filter	<p>Specifies the ICMP code filter for the ACE</p> <p>Any: no ICMP code filter is specified (ICMP code filter status is "don't-care").</p> <p>Specific: if you want to filter a specific ICMP code filter with the ACE, you can enter a specific ICMP code value. A field for entering an ICMP code value appears.</p>
ICMP Code Value	<p>When Specific is selected for the ICMP code filter, you can enter a specific ICMP code value. The allowed range is 0 to 255. A frame matching the ACE will use this ICMP code value.</p>

TCP Parameters

Source Port Filter	Specific ▾
Source Port No.	0
Dest. Port Filter	Specific ▾
Dest. Port No.	80
TCP FIN	Any ▾
TCP SYN	Any ▾
TCP RST	Any ▾
TCP PSH	Any ▾
TCP ACK	Any ▾
TCP URG	Any ▾

UDP Parameters

Source Port Filter	Specific ▾
Source Port No.	0
Dest. Port Filter	Range ▾
Dest. Port Range	80 - 65535

Label	Description
TCP/UDP Source Filter	<p>Specifies the TCP/UDP source filter for the ACE</p> <p>Any: no TCP/UDP source filter is specified (TCP/UDP source filter status is "don't-care").</p> <p>Specific: if you want to filter a specific TCP/UDP source filter with the ACE, you can enter a specific TCP/UDP source value. A field for entering a TCP/UDP source value appears.</p>

	<p>Range: if you want to filter a specific TCP/UDP source range filter with the ACE, you can enter a specific TCP/UDP source range. A field for entering a TCP/UDP source value appears.</p>
TCP/UDP Source No.	<p>When Specific is selected for the TCP/UDP source filter, you can enter a specific TCP/UDP source value. The allowed range is 0 to 65535. A frame matching the ACE will use this TCP/UDP source value.</p>
TCP/UDP Source Range	<p>When Range is selected for the TCP/UDP source filter, you can enter a specific TCP/UDP source range value. The allowed range is 0 to 65535. A frame matching the ACE will use this TCP/UDP source value.</p>
TCP/UDP Destination Filter	<p>Specifies the TCP/UDP destination filter for the ACE</p> <p>Any: no TCP/UDP destination filter is specified (TCP/UDP destination filter status is "don't-care").</p> <p>Specific: if you want to filter a specific TCP/UDP destination filter with the ACE, you can enter a specific TCP/UDP destination value. A field for entering a TCP/UDP destination value appears.</p> <p>Range: if you want to filter a specific range TCP/UDP destination filter with the ACE, you can enter a specific TCP/UDP destination range. A field for entering a TCP/UDP destination value appears.</p>
TCP/UDP Destination Number	<p>When Specific is selected for the TCP/UDP destination filter, you can enter a specific TCP/UDP destination value. The allowed range is 0 to 65535. A frame matching the ACE will use this TCP/UDP destination value.</p>
TCP/UDP Destination Range	<p>When Range is selected for the TCP/UDP destination filter, you can enter a specific TCP/UDP destination range value. The allowed range is 0 to 65535. A frame matching the ACE will use this TCP/UDP destination value.</p>
TCP FIN	<p>Specifies the TCP FIN ("no more data from sender") value for the ACE.</p> <p>0: TCP frames where the FIN field is set must not be able to match this entry.</p> <p>1: TCP frames where the FIN field is set must be able to match this entry.</p> <p>Any: any value is allowed ("don't-care").</p>
TCP SYN	<p>Specifies the TCP SYN ("synchronize sequence numbers") value for the ACE</p>

	<p>0: TCP frames where the SYN field is set must not be able to match this entry.</p> <p>1: TCP frames where the SYN field is set must be able to match this entry.</p> <p>Any: any value is allowed ("don't-care").</p>
TCP PSH	<p>Specifies the TCP PSH ("push function") value for the ACE</p> <p>0: TCP frames where the PSH field is set must not be able to match this entry.</p> <p>1: TCP frames where the PSH field is set must be able to match this entry.</p> <p>Any: any value is allowed ("don't-care").</p>
TCP ACK	<p>Specifies the TCP ACK ("acknowledgment field significant") value for the ACE</p> <p>0: TCP frames where the ACK field is set must not be able to match this entry.</p> <p>1: TCP frames where the ACK field is set must be able to match this entry.</p> <p>Any: any value is allowed ("don't-care").</p>
TCP URG	<p>Specifies the TCP URG ("urgent pointer field significant") value for the ACE</p> <p>0: TCP frames where the URG field is set must not be able to match this entry.</p> <p>1: TCP frames where the URG field is set must be able to match this entry.</p> <p>Any: any value is allowed ("don't-care").</p>

5.8.4 Authentication, Authorization, and Accounting

An AAA server is an application that provides authentication, authorization, and accounting services for attempted access to a network. An AAA server can reside in a dedicated computer, an Ethernet switch, an access point or a network access server. The current standard by which devices or applications communicate with an AAA server is RADIUS (Remote Authentication Dial-In User Service). RADIUS is a protocol used between the switch and the authentication server. This page allows you to configure common settings for an authentication server.

Authentication Server Configuration

Common Server Configuration

Timeout	15	seconds
Dead Time	300	seconds

Label	Description
Timeout	<p>The timeout, which can be set to a number between 3 and 3600 seconds, is the maximum time to wait for a reply from a server. If the server does not reply within this time frame, we will consider it to be dead and continue with the next enabled server (if any).</p> <p>RADIUS servers are using the UDP protocol, which is unreliable by design. In order to cope with lost frames, the timeout interval is divided into 3 subintervals of equal length. If a reply is not received within the subinterval, the request is transmitted again. This algorithm causes the RADIUS server to be queried up to 3 times before it is considered to be dead.</p>
Dead Time	<p>The dead time, which can be set to a number between 0 and 3600 seconds, is the period during which the switch will not send new requests to a server that has failed to respond to a previous request. This will stop the switch from continually trying to contact a server that it has already determined as dead.</p> <p>Setting the dead time to a value greater than 0 (zero) will enable this feature, but only if more than one server has been configured.</p>

5.8.5 RADIUS

Authentication and Accounting Server

When a user requests network connection, a RADIUS client which receives the request will perform an initial access negotiation with the user to obtain identity/password information. The client then passes the information to a RADIUS server as part of an authentication/authorization request.

The RADIUS server matches data from the authentication/authorization request with information in a trusted database. If a match is found and the user's credentials are correct, the RADIUS server sends an accept message to the client to grant access. If a match is not found or a problem is found with the user's credentials, the server returns a reject message to deny access. The NAD then establishes or terminates the user's connection. The NAD may then

forward accounting information to the RADIUS server to document the transaction; the RADIUS server may store or forward this information as needed to support billing for the services provided.

RADIUS Authentication Server Configuration

#	Enabled	IP Address	Port	Secret
1	<input type="checkbox"/>		1812	
2	<input type="checkbox"/>		1812	
3	<input type="checkbox"/>		1812	
4	<input type="checkbox"/>		1812	
5	<input type="checkbox"/>		1812	

Label	Description
#	The RADIUS authentication server number for which the configuration below applies.
Enabled	Check to enable the RADIUS authentication server.
IP Address	The IP address or hostname of the RADIUS authentication server. IP address is expressed in dotted decimal notation.
Port	The UDP port to use on the RADIUS authentication server. If the port is set to 0 (zero), the default port (1812) is used on the RADIUS authentication server.
Secret	The secret is a text string used by RADIUS to encrypt the client and server authenticator field during exchanges between the router and a RADIUS authentication server. The router encrypts PPP PAP passwords using this text string. The secret - up to 29 characters long - shared between the RADIUS authentication server and the switch stack.

RADIUS Accounting Server Configuration

#	Enabled	IP Address	Port	Secret
1	<input type="checkbox"/>		1813	
2	<input type="checkbox"/>		1813	
3	<input type="checkbox"/>		1813	
4	<input type="checkbox"/>		1813	
5	<input type="checkbox"/>		1813	

Save Reset

Label	Description
#	The RADIUS accounting server number for which the configuration below applies.
Enabled	Check to enable the RADIUS accounting server
IP Address	The IP address or hostname of the RADIUS accounting server. IP address is expressed in dotted decimal notation.
Port	The UDP port to use on the RADIUS accounting server. If the port is set to 0 (zero), the default port (1813) is used on the RADIUS accounting server.
Secret	The secret is a text string used by RADIUS to encrypt the client and server authenticator field during exchanges between the router and a RADIUS authentication server. The router encrypts PPP PAP passwords using this text string. The secret - up to 29 characters long - shared between the RADIUS authentication server and the switch stack.

Authentication and Accounting Server Status

This page provides information about the status of the RADIUS server configurable on the authentication configuration page.

RADIUS Authentication Server Status Overview

Auto-refresh Refresh

#	IP Address	Status
1	0.0.0.0:1812	Disabled
2	0.0.0.0:1812	Disabled
3	0.0.0.0:1812	Disabled
4	0.0.0.0:1812	Disabled
5	0.0.0.0:1812	Disabled

Label	Description
#	The RADIUS server number. Click to navigate to detailed statistics of the server
IP Address	The IP address and UDP port number (in <IP Address>:<UDP Port> notation) of the server
Status	The current status of the server. This field has one of the following values: Disabled: the server is disabled. Not Ready: the server is enabled, but IP communication is not yet up and running.

	<p>Ready: the server is enabled, IP communications are built, and the RADIUS module is ready to accept access attempts.</p> <p>Dead (X seconds left): access attempts are made to this server, but it does not reply within the configured timeout. The server has temporarily been disabled, but will be re-enabled when the dead-time expires. The number of seconds left before this occurs is displayed in parentheses. This state is only reachable when more than one server is enabled.</p>
--	--

RADIUS Accounting Server Status Overview

#	IP Address	Status
1	0.0.0.0:1813	Disabled
2	0.0.0.0:1813	Disabled
3	0.0.0.0:1813	Disabled
4	0.0.0.0:1813	Disabled
5	0.0.0.0:1813	Disabled

Label	Description
#	The RADIUS server number. Click to navigate to detailed statistics of the server
IP Address	The IP address and UDP port number (in <IP Address>:<UDP Port> notation) of the server
Status	<p>The current status of the server. This field has one of the following values:</p> <p>Disabled: the server is disabled.</p> <p>Not Ready: the server is enabled, but IP communication is not yet up and running.</p> <p>Ready: the server is enabled, IP communication is up and running, and the RADIUS module is ready to accept accounting attempts.</p> <p>Dead (X seconds left): accounting attempts are made to this server, but it does not reply within the configured timeout. The server has temporarily been disabled, but will be re-enabled when the dead-time expires. The number of seconds left before this occurs is displayed in parentheses. This state is only reachable when more than one server is enabled.</p>

Authentication and Accounting Server Statistics

This page shows the access statistics of the authentication and accounting servers. Use the server drop-down list to switch between the backend servers to show related details.

RADIUS Authentication Statistics for Server #1

Server #1 Auto-refresh

Receive Packets		Transmit Packets	
Access Accepts	0	Access Requests	0
Access Rejects	0	Access Retransmissions	0
Access Challenges	0	Pending Requests	0
Malformed Access Responses	0	Timeouts	0
Bad Authenticators	0		
Unknown Types	0		
Packets Dropped	0		
Other Info			
IP Address	0.0.0.0:1812		
State	Disabled		
Round-Trip Time	0 ms		

Label	Description																																																
Packet Counters	RADIUS authentication server packet counters. There are seven 'receive' and four 'transmit' counters.																																																
	<table border="1" style="width: 100%; border-collapse: collapse; font-size: small;"> <thead> <tr style="background-color: #003366; color: white;"> <th>Direction</th> <th>Name</th> <th>RFC4668 Name</th> <th>Description</th> </tr> </thead> <tbody> <tr> <td>Rx</td> <td>Access Accepts</td> <td>radiusAuthClientExtAccessAccepts</td> <td>The number of RADIUS Access-Accept packets (valid or invalid) received from the server.</td> </tr> <tr> <td>Rx</td> <td>Access Rejects</td> <td>radiusAuthClientExtAccessRejects</td> <td>The number of RADIUS Access-Reject packets (valid or invalid) received from the server.</td> </tr> <tr> <td>Rx</td> <td>Access Challenges</td> <td>radiusAuthClientExtAccessChallenges</td> <td>The number of RADIUS Access-Challenge packets (valid or invalid) received from the server.</td> </tr> <tr> <td>Rx</td> <td>Malformed Access Responses</td> <td>radiusAuthClientExtMalformedAccessResponses</td> <td>The number of malformed RADIUS Access-Response packets received from the server. Malformed packets include packets with an invalid length. Bad authenticators or Message Authenticator attributes or unknown types are not included as malformed access responses.</td> </tr> <tr> <td>Rx</td> <td>Bad Authenticators</td> <td>radiusAuthClientExtBadAuthenticators</td> <td>The number of RADIUS Access-Response packets containing invalid authenticators or Message Authenticator attributes received from the server.</td> </tr> <tr> <td>Rx</td> <td>Unknown Types</td> <td>radiusAuthClientExtUnknownTypes</td> <td>The number of RADIUS packets that were received from the server on the authentication port and dropped for some other reason.</td> </tr> <tr> <td>Rx</td> <td>Packets Dropped</td> <td>radiusAuthClientExtPacketsDropped</td> <td>The number of RADIUS packets that were received from the server on the authentication port and dropped for some other reason.</td> </tr> <tr> <td>Tx</td> <td>Access Requests</td> <td>radiusAuthClientExtAccessRequests</td> <td>The number of RADIUS Access-Request packets sent to the server. This does not include retransmissions.</td> </tr> <tr> <td>Tx</td> <td>Access Retransmissions</td> <td>radiusAuthClientExtAccessRetransmissions</td> <td>The number of RADIUS Access-Request packets retransmitted to the RADIUS authentication server.</td> </tr> <tr> <td>Tx</td> <td>Pending Requests</td> <td>radiusAuthClientExtPendingRequests</td> <td>The number of RADIUS Access-Request packets destined for the server that have not yet timed out or received a response. This variable is incremented when an Access-Request is sent and decremented due to receipt of an Access-Accept, Access-Reject, Access-Challenge, timeout, or retransmission.</td> </tr> <tr> <td>Tx</td> <td>Timeouts</td> <td>radiusAuthClientExtTimeouts</td> <td>The number of authentication timeouts to the server. After a timeout, the client may retry to the same server, send to a different server, or give up. A retry to the same server is counted as a retransmit as well as a timeout. A send to a different server is counted as a Request as well as a timeout.</td> </tr> </tbody> </table>	Direction	Name	RFC4668 Name	Description	Rx	Access Accepts	radiusAuthClientExtAccessAccepts	The number of RADIUS Access-Accept packets (valid or invalid) received from the server.	Rx	Access Rejects	radiusAuthClientExtAccessRejects	The number of RADIUS Access-Reject packets (valid or invalid) received from the server.	Rx	Access Challenges	radiusAuthClientExtAccessChallenges	The number of RADIUS Access-Challenge packets (valid or invalid) received from the server.	Rx	Malformed Access Responses	radiusAuthClientExtMalformedAccessResponses	The number of malformed RADIUS Access-Response packets received from the server. Malformed packets include packets with an invalid length. Bad authenticators or Message Authenticator attributes or unknown types are not included as malformed access responses.	Rx	Bad Authenticators	radiusAuthClientExtBadAuthenticators	The number of RADIUS Access-Response packets containing invalid authenticators or Message Authenticator attributes received from the server.	Rx	Unknown Types	radiusAuthClientExtUnknownTypes	The number of RADIUS packets that were received from the server on the authentication port and dropped for some other reason.	Rx	Packets Dropped	radiusAuthClientExtPacketsDropped	The number of RADIUS packets that were received from the server on the authentication port and dropped for some other reason.	Tx	Access Requests	radiusAuthClientExtAccessRequests	The number of RADIUS Access-Request packets sent to the server. This does not include retransmissions.	Tx	Access Retransmissions	radiusAuthClientExtAccessRetransmissions	The number of RADIUS Access-Request packets retransmitted to the RADIUS authentication server.	Tx	Pending Requests	radiusAuthClientExtPendingRequests	The number of RADIUS Access-Request packets destined for the server that have not yet timed out or received a response. This variable is incremented when an Access-Request is sent and decremented due to receipt of an Access-Accept, Access-Reject, Access-Challenge, timeout, or retransmission.	Tx	Timeouts	radiusAuthClientExtTimeouts	The number of authentication timeouts to the server. After a timeout, the client may retry to the same server, send to a different server, or give up. A retry to the same server is counted as a retransmit as well as a timeout. A send to a different server is counted as a Request as well as a timeout.
	Direction	Name	RFC4668 Name	Description																																													
	Rx	Access Accepts	radiusAuthClientExtAccessAccepts	The number of RADIUS Access-Accept packets (valid or invalid) received from the server.																																													
	Rx	Access Rejects	radiusAuthClientExtAccessRejects	The number of RADIUS Access-Reject packets (valid or invalid) received from the server.																																													
	Rx	Access Challenges	radiusAuthClientExtAccessChallenges	The number of RADIUS Access-Challenge packets (valid or invalid) received from the server.																																													
	Rx	Malformed Access Responses	radiusAuthClientExtMalformedAccessResponses	The number of malformed RADIUS Access-Response packets received from the server. Malformed packets include packets with an invalid length. Bad authenticators or Message Authenticator attributes or unknown types are not included as malformed access responses.																																													
	Rx	Bad Authenticators	radiusAuthClientExtBadAuthenticators	The number of RADIUS Access-Response packets containing invalid authenticators or Message Authenticator attributes received from the server.																																													
	Rx	Unknown Types	radiusAuthClientExtUnknownTypes	The number of RADIUS packets that were received from the server on the authentication port and dropped for some other reason.																																													
	Rx	Packets Dropped	radiusAuthClientExtPacketsDropped	The number of RADIUS packets that were received from the server on the authentication port and dropped for some other reason.																																													
	Tx	Access Requests	radiusAuthClientExtAccessRequests	The number of RADIUS Access-Request packets sent to the server. This does not include retransmissions.																																													
Tx	Access Retransmissions	radiusAuthClientExtAccessRetransmissions	The number of RADIUS Access-Request packets retransmitted to the RADIUS authentication server.																																														
Tx	Pending Requests	radiusAuthClientExtPendingRequests	The number of RADIUS Access-Request packets destined for the server that have not yet timed out or received a response. This variable is incremented when an Access-Request is sent and decremented due to receipt of an Access-Accept, Access-Reject, Access-Challenge, timeout, or retransmission.																																														
Tx	Timeouts	radiusAuthClientExtTimeouts	The number of authentication timeouts to the server. After a timeout, the client may retry to the same server, send to a different server, or give up. A retry to the same server is counted as a retransmit as well as a timeout. A send to a different server is counted as a Request as well as a timeout.																																														

Other Info	<p>This section contains information about the state of the server and the latest round-trip time.</p> <table border="1"> <thead> <tr> <th>Name</th> <th>RFC4668 Name</th> <th>Description</th> </tr> </thead> <tbody> <tr> <td>State</td> <td>-</td> <td>Shows the state of the server. It takes one of the following values: Disabled : The selected server is disabled. Not Ready : The server is enabled, but IP communication is not yet up and running. Ready : The server is enabled, IP communication is up and running, and the RADIUS module is ready to accept access attempts. Dead (X seconds left) : Access attempts were made to this server, but it did not reply within the configured timeout. The server has temporarily been disabled, but will get re-enabled when the dead-time expires. The number of seconds left before this occurs is displayed in parentheses. This state is only reachable when more than one server is enabled.</td> </tr> <tr> <td>Round-Trip Time</td> <td>radiusAuthClientExtRoundTripTime</td> <td>The time interval (measured in milliseconds) between the most recent Access-Reply/Access-Challenge and the Access-Request that matched it from the RADIUS authentication server. The granularity of this measurement is 100 ms. A value of 0 ms indicates that there hasn't been round-trip communication with the server yet.</td> </tr> </tbody> </table>	Name	RFC4668 Name	Description	State	-	Shows the state of the server. It takes one of the following values: Disabled : The selected server is disabled. Not Ready : The server is enabled, but IP communication is not yet up and running. Ready : The server is enabled, IP communication is up and running, and the RADIUS module is ready to accept access attempts. Dead (X seconds left) : Access attempts were made to this server, but it did not reply within the configured timeout. The server has temporarily been disabled, but will get re-enabled when the dead-time expires. The number of seconds left before this occurs is displayed in parentheses. This state is only reachable when more than one server is enabled.	Round-Trip Time	radiusAuthClientExtRoundTripTime	The time interval (measured in milliseconds) between the most recent Access-Reply/Access-Challenge and the Access-Request that matched it from the RADIUS authentication server. The granularity of this measurement is 100 ms. A value of 0 ms indicates that there hasn't been round-trip communication with the server yet.
Name	RFC4668 Name	Description								
State	-	Shows the state of the server. It takes one of the following values: Disabled : The selected server is disabled. Not Ready : The server is enabled, but IP communication is not yet up and running. Ready : The server is enabled, IP communication is up and running, and the RADIUS module is ready to accept access attempts. Dead (X seconds left) : Access attempts were made to this server, but it did not reply within the configured timeout. The server has temporarily been disabled, but will get re-enabled when the dead-time expires. The number of seconds left before this occurs is displayed in parentheses. This state is only reachable when more than one server is enabled.								
Round-Trip Time	radiusAuthClientExtRoundTripTime	The time interval (measured in milliseconds) between the most recent Access-Reply/Access-Challenge and the Access-Request that matched it from the RADIUS authentication server. The granularity of this measurement is 100 ms. A value of 0 ms indicates that there hasn't been round-trip communication with the server yet.								

RADIUS Accounting Statistics for Server #1

Receive Packets		Transmit Packets	
Responses	0	Requests	0
Malformed Responses	0	Retransmissions	0
Bad Authenticators	0	Pending Requests	0
Unknown Types	0	Timeouts	0
Packets Dropped	0		
Other Info			
IP Address		0.0.0.0:1813	
State		Disabled	
Round-Trip Time		0 ms	

Label	Description																																								
Packet Counters	<p>RADIUS accounting server packet counters. There are five 'receive' and four 'transmit' counters.</p> <table border="1"> <thead> <tr> <th>Direction</th> <th>Name</th> <th>RFC4670 Name</th> <th>Description</th> </tr> </thead> <tbody> <tr> <td>Rx</td> <td>Responses</td> <td>radiusAccClientExtResponses</td> <td>The number of RADIUS packets (valid or invalid) received from the server.</td> </tr> <tr> <td>Rx</td> <td>Malformed Responses</td> <td>radiusAccClientExtMalformedResponses</td> <td>The number of malformed RADIUS packets received from the server. Malformed packets include packets with an invalid length. Bad authenticators or unknown types are not included as malformed access responses.</td> </tr> <tr> <td>Rx</td> <td>Bad Authenticators</td> <td>radiusAccClientExtBadAuthenticators</td> <td>The number of RADIUS packets containing invalid authenticators received from the server.</td> </tr> <tr> <td>Rx</td> <td>Unknown Types</td> <td>radiusAccClientExtUnknownTypes</td> <td>The number of RADIUS packets of unknown types that were received from the server on the accounting port.</td> </tr> <tr> <td>Rx</td> <td>Packets Dropped</td> <td>radiusAccClientExtPacketsDropped</td> <td>The number of RADIUS packets that were received from the server on the accounting port and dropped for some other reason.</td> </tr> <tr> <td>Tx</td> <td>Requests</td> <td>radiusAccClientExtRequests</td> <td>The number of RADIUS packets sent to the server. This does not include retransmissions.</td> </tr> <tr> <td>Tx</td> <td>Retransmissions</td> <td>radiusAccClientExtRetransmissions</td> <td>The number of RADIUS packets retransmitted to the RADIUS accounting server.</td> </tr> <tr> <td>Tx</td> <td>Pending Requests</td> <td>radiusAccClientExtPendingRequests</td> <td>The number of RADIUS packets destined for the server that have not yet timed out or received a response. This variable is incremented when a Request is sent and decremented due to receipt of a Response, timeout, or retransmission.</td> </tr> <tr> <td>Tx</td> <td>Timeouts</td> <td>radiusAccClientExtTimeouts</td> <td>The number of accounting timeouts to the server. After a timeout, the client may retry to the same server, send to a different server, or give up. A retry to the same server is counted as a retransmit as well as a timeout. A send to a different server is counted as a Request as well as a timeout.</td> </tr> </tbody> </table>	Direction	Name	RFC4670 Name	Description	Rx	Responses	radiusAccClientExtResponses	The number of RADIUS packets (valid or invalid) received from the server.	Rx	Malformed Responses	radiusAccClientExtMalformedResponses	The number of malformed RADIUS packets received from the server. Malformed packets include packets with an invalid length. Bad authenticators or unknown types are not included as malformed access responses.	Rx	Bad Authenticators	radiusAccClientExtBadAuthenticators	The number of RADIUS packets containing invalid authenticators received from the server.	Rx	Unknown Types	radiusAccClientExtUnknownTypes	The number of RADIUS packets of unknown types that were received from the server on the accounting port.	Rx	Packets Dropped	radiusAccClientExtPacketsDropped	The number of RADIUS packets that were received from the server on the accounting port and dropped for some other reason.	Tx	Requests	radiusAccClientExtRequests	The number of RADIUS packets sent to the server. This does not include retransmissions.	Tx	Retransmissions	radiusAccClientExtRetransmissions	The number of RADIUS packets retransmitted to the RADIUS accounting server.	Tx	Pending Requests	radiusAccClientExtPendingRequests	The number of RADIUS packets destined for the server that have not yet timed out or received a response. This variable is incremented when a Request is sent and decremented due to receipt of a Response, timeout, or retransmission.	Tx	Timeouts	radiusAccClientExtTimeouts	The number of accounting timeouts to the server. After a timeout, the client may retry to the same server, send to a different server, or give up. A retry to the same server is counted as a retransmit as well as a timeout. A send to a different server is counted as a Request as well as a timeout.
Direction	Name	RFC4670 Name	Description																																						
Rx	Responses	radiusAccClientExtResponses	The number of RADIUS packets (valid or invalid) received from the server.																																						
Rx	Malformed Responses	radiusAccClientExtMalformedResponses	The number of malformed RADIUS packets received from the server. Malformed packets include packets with an invalid length. Bad authenticators or unknown types are not included as malformed access responses.																																						
Rx	Bad Authenticators	radiusAccClientExtBadAuthenticators	The number of RADIUS packets containing invalid authenticators received from the server.																																						
Rx	Unknown Types	radiusAccClientExtUnknownTypes	The number of RADIUS packets of unknown types that were received from the server on the accounting port.																																						
Rx	Packets Dropped	radiusAccClientExtPacketsDropped	The number of RADIUS packets that were received from the server on the accounting port and dropped for some other reason.																																						
Tx	Requests	radiusAccClientExtRequests	The number of RADIUS packets sent to the server. This does not include retransmissions.																																						
Tx	Retransmissions	radiusAccClientExtRetransmissions	The number of RADIUS packets retransmitted to the RADIUS accounting server.																																						
Tx	Pending Requests	radiusAccClientExtPendingRequests	The number of RADIUS packets destined for the server that have not yet timed out or received a response. This variable is incremented when a Request is sent and decremented due to receipt of a Response, timeout, or retransmission.																																						
Tx	Timeouts	radiusAccClientExtTimeouts	The number of accounting timeouts to the server. After a timeout, the client may retry to the same server, send to a different server, or give up. A retry to the same server is counted as a retransmit as well as a timeout. A send to a different server is counted as a Request as well as a timeout.																																						

Other Info	This section contains information about the state of the server and the latest round-trip time.	
	Name	RFC4670 Name
	State	Description
		Shows the state of the server. It takes one of the following values: Disabled : The selected server is disabled. Not_Ready : The server is enabled, but IP communication is not yet up and running. Ready : The server is enabled, IP communication is up and running, and the RADIUS module is ready to accept accounting attempts. Dead (X seconds left) : Accounting attempts were made to this server, but it did not reply within the configured timeout. The server has temporarily been disabled, but will get re-enabled when the dead-time expires. The number of seconds left before this occurs is displayed in parentheses. This state is only reachable when more than one server is enabled.
Round-Trip Time	radiusAccClientExtRoundTripTime	The time interval (measured in milliseconds) between the most recent Response and the Request that matched it from the RADIUS accounting server. The granularity of this measurement is 100 ms. A value of 0 ms indicates that there hasn't been round-trip communication with the server yet.

5.8.6 NAS (802.1x)

A NAS (Network Access Server) is an access gateway between an external communications network and an internal network. For example, when the user dials into the ISP, he/she will be given access to the Internet after being authorized by the access server. The authentication between the client and the server include IEEE 802.1X- and MAC-based.

The IEEE 802.1X standard defines a port-based access control procedure that prevents unauthorized access to a network by requiring users to first submit credentials for authentication. One or more backend servers (RADIUS) determine whether the user is allowed access to the network.

MAC-based authentication allows for authentication of more than one user on the same port, and does not require the users to have special 802.1X software installed on their system. The switch uses the users' MAC addresses to authenticate against the backend server. As intruders can create counterfeit MAC addresses, MAC-based authentication is less secure than 802.1X authentication.

Overview of 802.1X (Port-Based) Authentication

In an 802.1X network environment, the user is called the supplicant, the switch is the authenticator, and the RADIUS server is the authentication server. The switch acts as the man-in-the-middle, forwarding requests and responses between the supplicant and the authentication server. Frames sent between the supplicant and the switch are special 802.1X frames, known as EAPOL (EAP Over LANs) frames which encapsulate EAP PDUs (RFC3748). Frames sent between the switch and the RADIUS server are RADIUS packets. RADIUS packets also encapsulate EAP PDUs together with other attributes like the switch's IP address, name, and the supplicant's port number on the switch. EAP is very flexible as it allows for different authentication methods, like MD5-Challenge, PEAP, and TLS. The important thing is that the authenticator (the switch) does not need to know which authentication method the supplicant and the authentication server are using, or how many information exchange frames are needed for a particular method. The switch simply encapsulates the EAP part of the frame

into the relevant type (EAPOL or RADIUS) and forwards it.

When authentication is complete, the RADIUS server sends a special packet containing a success or failure indication. Besides forwarding the result to the supplicant, the switch uses it to open up or block traffic on the switch port connected to the supplicant.

Note: in an environment where two backend servers are enabled, the server timeout is configured to X seconds (using the authentication configuration page), and the first server in the list is currently down (but not considered dead), if the supplicant retransmits EAPOL Start frames at a rate faster than X seconds, it will never be authenticated because the switch will cancel on-going backend authentication server requests whenever it receives a new EAPOL Start frame from the supplicant. Since the server has not failed (because the X seconds have not expired), the same server will be contacted when the next backend authentication server request from the switch. This scenario will loop forever. Therefore, the server timeout should be smaller than the supplicant's EAPOL Start frame retransmission rate.

Overview of MAC-Based Authentication

Unlike 802.1X, MAC-based authentication is not a standard, but merely a best-practices method adopted by the industry. In MAC-based authentication, users are called clients, and the switch acts as the supplicant on behalf of clients. The initial frame (any kind of frame) sent by a client is snooped by the switch, which in turn uses the client's MAC address as both username and password in the subsequent EAP exchange with the RADIUS server. The 6-byte MAC address is converted to a string in the following form "xx-xx-xx-xx-xx-xx", that is, a dash (-) is used as separator between the lower-cased hexadecimal digits. The switch only supports the MD5-Challenge authentication method, so the RADIUS server must be configured accordingly.

When authentication is complete, the RADIUS server sends a success or failure indication, which in turn causes the switch to open up or block traffic for that particular client, using static entries into the MAC Table. Only then will frames from the client be forwarded on the switch. There are no EAPOL frames involved in this authentication, and therefore, MAC-based authentication has nothing to do with the 802.1X standard.

The advantage of MAC-based authentication over 802.1X is that several clients can be connected to the same port (e.g. through a 3rd party switch or a hub) and still require individual authentication, and that the clients do not need special supplicant software to authenticate. The disadvantage is that MAC addresses can be spoofed by malicious users, equipment whose MAC address is a valid RADIUS user can be used by anyone, and only the MD5-Challenge method is supported.

802.1X and MAC-Based authentication configurations consist of two sections: system- and port-wide.

Refresh

Network Access Server Configuration

System Configuration

Mode	Disabled	
Reauthentication Enabled	<input type="checkbox"/>	
Reauthentication Period	3600	seconds
EAPOL Timeout	30	seconds
Aging Period	300	seconds
Hold Time	10	seconds

Port Configuration

Port	Admin State	Port State	Restart	
*	<>			
1	Force Authorized	Globally Disabled	Reauthenticate	Reinitialize
2	Force Unauthorized	Globally Disabled	Reauthenticate	Reinitialize
3	802.1X	Globally Disabled	Reauthenticate	Reinitialize
4	MAC-based Auth.	Globally Disabled	Reauthenticate	Reinitialize
5	Force Authorized	Globally Disabled	Reauthenticate	Reinitialize

Label	Description
Mode	Indicates if 802.1X and MAC-based authentication is globally enabled or disabled on the switch. If globally disabled, all ports are allowed to forward frames.
Reauthentication Enabled	If checked, clients are reauthenticated after the interval specified by the Reauthentication Period. Reauthentication for 802.1X-enabled ports can be used to detect if a new device is plugged into a switch port. For MAC-based ports, reauthentication is only useful if the RADIUS server configuration has changed. It does not involve communication between the switch and the client, and therefore does not imply that a client is still present on a port (see Age Period below).
Reauthentication Period	Determines the period, in seconds, after which a connected client must be re-authenticated. This is only active if the Reauthentication Enabled checkbox is checked. Valid range of the value is 1 to 3600 seconds.
EAPOL Timeout	Determines the time for retransmission of Request Identity EAPOL frames.

	Valid range of the value is 1 to 65535 seconds. This has no effect for MAC-based ports.
Age Period	<p>This setting applies to the following modes, i.e. modes using the Port Security functionality to secure MAC addresses:</p> <p>MAC-Based Auth.:</p> <p>When the NAS module uses the Port Security module to secure MAC addresses, the Port Security module needs to check for activity on the MAC address in question at regular intervals and free resources if no activity is seen within a given period of time. This parameter controls exactly this period and can be set to a number between 10 and 1000000 seconds.</p> <p>For ports in MAC-based Auth. mode, reauthentication does not cause direct communications between the switch and the client, so this will not detect whether the client is still attached or not, and the only way to free any resources is to age the entry.</p>
Hold Time	<p>This setting applies to the following modes, i.e. modes using the Port Security functionality to secure MAC addresses:</p> <p>MAC-Based Auth.:</p> <p>If a client is denied access - either because the RADIUS server denies the client access or because the RADIUS server request times out (according to the timeout specified on the "Configuration→Security→AAA" page) - the client is put on hold in Unauthorized state. The hold timer does not count during an on-going authentication.</p> <p>The switch will ignore new frames coming from the client during the hold time.</p> <p>The hold time can be set to a number between 10 and 1000000 seconds.</p>
Port	The port number for which the configuration below applies
Admin State	<p>If NAS is globally enabled, this selection controls the port's authentication mode. The following modes are available:</p> <p>Force Authorized</p> <p>In this mode, the switch will send one EAPOL Success frame when the port link is up, and any client on the port will be allowed network access without authentication.</p> <p>Force Unauthorized</p> <p>In this mode, the switch will send one EAPOL Failure frame when</p>

the port link is up, and any client on the port will be disallowed network access.

Port-based 802.1X

In an 802.1X network environment, the user is called the supplicant, the switch is the authenticator, and the RADIUS server is the authentication server. The authenticator acts as the man-in-the-middle, forwarding requests and responses between the supplicant and the authentication server. Frames sent between the supplicant and the switch are special 802.1X frames, known as EAPOL (EAP Over LANs) frames which encapsulate EAP PDUs (RFC3748). Frames sent between the switch and the RADIUS server is RADIUS packets. RADIUS packets also encapsulate EAP PDUs together with other attributes like the switch's IP address, name, and the supplicant's port number on the switch. EAP is very flexible as it allows for different authentication methods, like MD5-Challenge, PEAP, and TLS. The important thing is that the authenticator (the switch) does not need to know which authentication method the supplicant and the authentication server are using, or how many information exchange frames are needed for a particular method. The switch simply encapsulates the EAP part of the frame into the relevant type (EAPOL or RADIUS) and forwards it.

When authentication is complete, the RADIUS server sends a special packet containing a success or failure indication. Besides forwarding the result to the supplicant, the switch uses it to open up or block traffic on the switch port connected to the supplicant.

Note: in an environment where two backend servers are enabled, the server timeout is configured to X seconds (using the authentication configuration page), and the first server in the list is currently down (but not considered dead), if the supplicant retransmits EAPOL Start frames at a rate faster than X seconds, it will never be authenticated because the switch will cancel on-going backend authentication server requests whenever it receives a new EAPOL Start frame from the supplicant. Since the server has not failed (because the X seconds have not expired), the same server will be contacted when the next backend authentication server request from the switch. This scenario will

loop forever. Therefore, the server timeout should be smaller than the supplicant's EAPOL Start frame retransmission rate.

a. Single 802.1X

In port-based 802.1X authentication, once a supplicant is successfully authenticated on a port, the whole port is opened for network traffic. This allows other clients connected to the port (for instance through a hub) to piggy-back on the successfully authenticated client and get network access even though they are not authenticated individually. To overcome this security breach, use the Single 802.1X variant.

Single 802.1X is not yet an IEEE standard, but features many of the same characteristics as port-based 802.1X. In Single 802.1X, at most one supplicant can get authenticated on the port at a time. Normal EAPOL frames are used in the communications between the supplicant and the switch. If more than one supplicant are connected to a port, the one that comes first when the port's link is connected will be the first one considered. If that supplicant does not provide valid credentials within a certain amount of time, the chance will be given to another supplicant. Once a supplicant is successfully authenticated, only that supplicant will be allowed access. This is the most secure of all the supported modes. In this mode, the Port Security module is used to secure a supplicant's MAC address once successfully authenticated.

b. Multi 802.1X

In port-based 802.1X authentication, once a supplicant is successfully authenticated on a port, the whole port is opened for network traffic. This allows other clients connected to the port (for instance through a hub) to piggy-back on the successfully authenticated client and get network access even though they are not authenticated individually. To overcome this security breach, use the Multi 802.1X variant.

Multi 802.1X is not yet an IEEE standard, but features many of the same characteristics as port-based 802.1X. In Multi 802.1X, one or more supplicants can be authenticated on the same port at the same time. Each supplicant is authenticated individually and secured in the MAC table using the Port Security module.

In Multi 802.1X it is not possible to use the multicast BPDU MAC

address as the destination MAC address for EAPOL frames sent from the switch to the supplicant, since that would cause all supplicants attached to the port to reply to requests sent from the switch. Instead, the switch uses the supplicant's MAC address, which is obtained from the first EAPOL Start or EAPOL Response Identity frame sent by the supplicant. An exception to this is when no supplicants are attached. In this case, the switch sends EAPOL Request Identity frames using the BPDU multicast MAC address as destination - to wake up any supplicants that might be on the port.

The maximum number of supplicants that can be attached to a port can be limited using the Port Security Limit Control functionality.

MAC-based Auth.

Unlike port-based 802.1X, MAC-based authentication is not a standard, but merely a best-practices method adopted by the industry. In MAC-based authentication, users are called clients, and the switch acts as the supplicant on behalf of clients. The initial frame (any kind of frame) sent by a client is snooped by the switch, which in turn uses the client's MAC address as both username and password in the subsequent EAP exchange with the RADIUS server. The 6-byte MAC address is converted to a string in the following form "xx-xx-xx-xx-xx-xx", that is, a dash (-) is used as separator between the lower-cased hexadecimal digits.

The switch only supports the MD5-Challenge authentication method, so the RADIUS server must be configured accordingly.

When authentication is complete, the RADIUS server sends a success or failure indication, which in turn causes the switch to open up or block traffic for that particular client, using the Port Security module. Only then will frames from the client be forwarded on the switch. There are no EAPOL frames involved in this authentication, and therefore, MAC-based authentication has nothing to do with the 802.1X standard.

The advantage of MAC-based authentication over port-based 802.1X is that several clients can be connected to the same port (e.g. through a 3rd party switch or a hub) and still require individual authentication, and that the clients don't need special

	<p>supplicant software to authenticate. The advantage of MAC-based authentication over 802.1X-based authentication is that the clients do not need special supplicant software to authenticate. The disadvantage is that MAC addresses can be spoofed by malicious users - equipment whose MAC address is a valid RADIUS user can be used by anyone. Also, only the MD5-Challenge method is supported. The maximum number of clients that can be attached to a port can be limited using the Port Security Limit Control functionality.</p>
<p>Port State</p>	<p>The current state of the port. It can undertake one of the following values:</p> <p>Globally Disabled: NAS is globally disabled.</p> <p>Link Down: NAS is globally enabled, but there is no link on the port.</p> <p>Authorized: the port is in Force Authorized or a single-supplicant mode and the supplicant is authorized.</p> <p>Unauthorized: the port is in Force Unauthorized or a single-supplicant mode and the supplicant is not successfully authorized by the RADIUS server.</p> <p>X Auth/Y Unauth: the port is in a multi-supplicant mode. Currently X clients are authorized and Y are unauthorized.</p>
<p>Restart</p>	<p>Two buttons are available for each row. The buttons are only enabled when authentication is globally enabled and the port's Admin State is in an EAPOL-based or MAC-based mode. Clicking these buttons will not cause settings changed on the page to take effect.</p> <p>Reauthenticate: schedules a reauthentication whenever the quiet-period of the port runs out (EAPOL-based authentication). For MAC-based authentication, reauthentication will be attempted immediately.</p> <p>The button only has effect on successfully authenticated clients on the port and will not cause the clients to be temporarily unauthorized.</p> <p>Reinitialize: forces a reinitialization of the clients on the port and hence a reauthentication immediately. The clients will transfer to the unauthorized state while the reauthentication is in progress.</p>

NAS Status

This page shows the information on current NAS port statuses.

Network Access Server Switch Status

Auto-refresh Refresh

Port	Admin State	Port State	Last Source	Last ID
1	Force Authorized	Globally Disabled		
2	Force Authorized	Globally Disabled		
3	Force Authorized	Globally Disabled		
4	Force Authorized	Globally Disabled		
5	Force Authorized	Globally Disabled		
6	Force Authorized	Globally Disabled		

Label	Description
Port	The switch port number. Click to navigate to detailed 802.1X statistics of each port.
Admin State	The port's current administrative state. Refer to NAS Admin State for more details regarding each value.
Port State	The current state of the port. Refer to NAS Port State for more details regarding each value.
Last Source	The source MAC address carried in the most recently received EAPOL frame for EAPOL-based authentication, and the most recently received frame from a new client for MAC-based authentication.
Last ID	The user name (supplicant identity) carried in the most recently received Response Identity EAPOL frame for EAPOL-based authentication, and the source MAC address from the most recently received frame from a new client for MAC-based authentication.

This page provides detailed IEEE 802.1X statistics for a specific switch port using port-based authentication. For MAC-based ports, only the statistics of selected backend server statistics will be shown. Use the drop-down list to select which port details to be displayed.

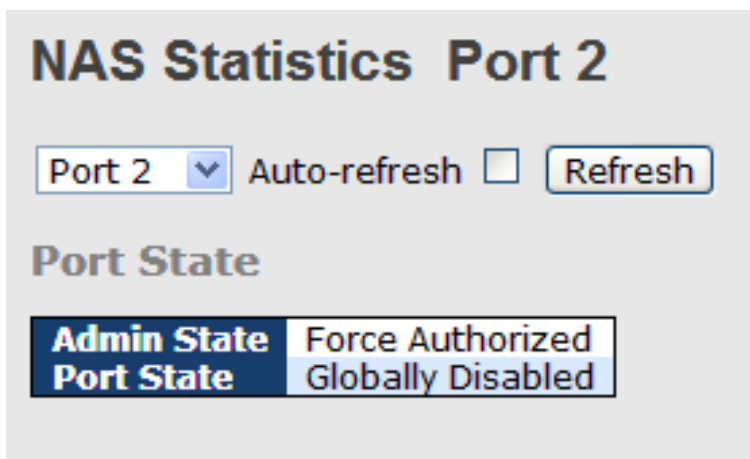

Label	Description																																																
Admin State	The port's current administrative state. Refer to NAS Admin State for more details regarding each value.																																																
Port State	The current state of the port. Refer to NAS Port State for more details regarding each value.																																																
EAPOL Counters	<p>These supplicant frame counters are available for the following administrative states:</p> <ul style="list-style-type: none"> • Force Authorized • Force Unauthorized • 802.1X <table border="1"> <thead> <tr> <th colspan="4">EAPOL Counters</th> </tr> <tr> <th>Direction</th> <th>Name</th> <th>IEEE Name</th> <th>Description</th> </tr> </thead> <tbody> <tr> <td>Rx</td> <td>Total</td> <td>dot1xAuthEapolFramesRx</td> <td>The number of valid EAPOL frames of any type that have been received by the switch.</td> </tr> <tr> <td>Rx</td> <td>Response ID</td> <td>dot1xAuthEapolRespIdFramesRx</td> <td>The number of valid EAP Resp/ID frames that have been received by the switch.</td> </tr> <tr> <td>Rx</td> <td>Responses</td> <td>dot1xAuthEapolRespFramesRx</td> <td>The number of valid EAPOL response frames (other than Resp/ID frames) that have been received by the switch.</td> </tr> <tr> <td>Rx</td> <td>Start</td> <td>dot1xAuthEapolStartFramesRx</td> <td>The number of EAPOL Start frames that have been received by the switch.</td> </tr> <tr> <td>Rx</td> <td>Logoff</td> <td>dot1xAuthEapolLogoffFramesRx</td> <td>The number of valid EAPOL logoff frames that have been received by the switch.</td> </tr> <tr> <td>Rx</td> <td>Invalid Type</td> <td>dot1xAuthInvalidEapolFramesRx</td> <td>The number of EAPOL frames that have been received by the switch in which the frame type is not recognized.</td> </tr> <tr> <td>Rx</td> <td>Invalid Length</td> <td>dot1xAuthEapolLengthErrorFramesRx</td> <td>The number of EAPOL frames that have been received by the switch in which the Packet Body Length field is invalid.</td> </tr> <tr> <td>Tx</td> <td>Total</td> <td>dot1xAuthEapolFramesTx</td> <td>The number of EAPOL frames of any type that have been transmitted by the switch.</td> </tr> <tr> <td>Tx</td> <td>Request ID</td> <td>dot1xAuthEapolReqIdFramesTx</td> <td>The number of EAP initial request frames that have been transmitted by the switch.</td> </tr> <tr> <td>Tx</td> <td>Requests</td> <td>dot1xAuthEapolReqFramesTx</td> <td>The number of valid EAP Request frames (other than initial request frames) that have been transmitted by the switch.</td> </tr> </tbody> </table>	EAPOL Counters				Direction	Name	IEEE Name	Description	Rx	Total	dot1xAuthEapolFramesRx	The number of valid EAPOL frames of any type that have been received by the switch.	Rx	Response ID	dot1xAuthEapolRespIdFramesRx	The number of valid EAP Resp/ID frames that have been received by the switch.	Rx	Responses	dot1xAuthEapolRespFramesRx	The number of valid EAPOL response frames (other than Resp/ID frames) that have been received by the switch.	Rx	Start	dot1xAuthEapolStartFramesRx	The number of EAPOL Start frames that have been received by the switch.	Rx	Logoff	dot1xAuthEapolLogoffFramesRx	The number of valid EAPOL logoff frames that have been received by the switch.	Rx	Invalid Type	dot1xAuthInvalidEapolFramesRx	The number of EAPOL frames that have been received by the switch in which the frame type is not recognized.	Rx	Invalid Length	dot1xAuthEapolLengthErrorFramesRx	The number of EAPOL frames that have been received by the switch in which the Packet Body Length field is invalid.	Tx	Total	dot1xAuthEapolFramesTx	The number of EAPOL frames of any type that have been transmitted by the switch.	Tx	Request ID	dot1xAuthEapolReqIdFramesTx	The number of EAP initial request frames that have been transmitted by the switch.	Tx	Requests	dot1xAuthEapolReqFramesTx	The number of valid EAP Request frames (other than initial request frames) that have been transmitted by the switch.
EAPOL Counters																																																	
Direction	Name	IEEE Name	Description																																														
Rx	Total	dot1xAuthEapolFramesRx	The number of valid EAPOL frames of any type that have been received by the switch.																																														
Rx	Response ID	dot1xAuthEapolRespIdFramesRx	The number of valid EAP Resp/ID frames that have been received by the switch.																																														
Rx	Responses	dot1xAuthEapolRespFramesRx	The number of valid EAPOL response frames (other than Resp/ID frames) that have been received by the switch.																																														
Rx	Start	dot1xAuthEapolStartFramesRx	The number of EAPOL Start frames that have been received by the switch.																																														
Rx	Logoff	dot1xAuthEapolLogoffFramesRx	The number of valid EAPOL logoff frames that have been received by the switch.																																														
Rx	Invalid Type	dot1xAuthInvalidEapolFramesRx	The number of EAPOL frames that have been received by the switch in which the frame type is not recognized.																																														
Rx	Invalid Length	dot1xAuthEapolLengthErrorFramesRx	The number of EAPOL frames that have been received by the switch in which the Packet Body Length field is invalid.																																														
Tx	Total	dot1xAuthEapolFramesTx	The number of EAPOL frames of any type that have been transmitted by the switch.																																														
Tx	Request ID	dot1xAuthEapolReqIdFramesTx	The number of EAP initial request frames that have been transmitted by the switch.																																														
Tx	Requests	dot1xAuthEapolReqFramesTx	The number of valid EAP Request frames (other than initial request frames) that have been transmitted by the switch.																																														
Backend Server Counters	<p>These backend (RADIUS) frame counters are available for the following administrative states:</p> <ul style="list-style-type: none"> • 802.1X • MAC-based Auth. 																																																

	<table border="1"> <thead> <tr> <th colspan="4">Backend Server Counters</th> </tr> <tr> <th>Direction</th> <th>Name</th> <th>IEEE Name</th> <th>Description</th> </tr> </thead> <tbody> <tr> <td>Rx</td> <td>Access Challenges</td> <td>dot1xAuthBackendAccessChallenges</td> <td>Port-based: Counts the number of times that the switch receives the first request from the backend server following the first response from the supplicant. Indicates that the backend server has communication with the switch. MAC-based: Counts all Access Challenges received from the backend server for this port (left-most table) or client (right-most table).</td> </tr> <tr> <td>Rx</td> <td>Other Requests</td> <td>dot1xAuthBackendOtherRequestsToSupplicant</td> <td>Port-based: Counts the number of times that the switch sends an EAP Request packet following the first to the supplicant. Indicates that the backend server chose an EAP-method. MAC-based: Not applicable.</td> </tr> <tr> <td>Rx</td> <td>Auth. Successes</td> <td>dot1xAuthBackendAuthSuccesses</td> <td>Port- and MAC-based: Counts the number of times that the switch receives a success indication. Indicates that the supplicant/client has successfully authenticated to the backend server.</td> </tr> <tr> <td>Rx</td> <td>Auth. Failures</td> <td>dot1xAuthBackendAuthFails</td> <td>Port- and MAC-based: Counts the number of times that the switch receives a failure message. This indicates that the supplicant/client has not authenticated to the backend server.</td> </tr> <tr> <td>Tx</td> <td>Responses</td> <td>dot1xAuthBackendResponses</td> <td>Port-based: Counts the number of times that the switch attempts to send a supplicant's first response packet to the backend server. Indicates the switch attempted communication with the backend server. Possible retransmissions are not counted. MAC-based: Counts all the backend server packets sent from the switch towards the backend server for a given port (left-most table) or client (right-most table). Possible retransmissions are not counted.</td> </tr> </tbody> </table>	Backend Server Counters				Direction	Name	IEEE Name	Description	Rx	Access Challenges	dot1xAuthBackendAccessChallenges	Port-based: Counts the number of times that the switch receives the first request from the backend server following the first response from the supplicant. Indicates that the backend server has communication with the switch. MAC-based: Counts all Access Challenges received from the backend server for this port (left-most table) or client (right-most table).	Rx	Other Requests	dot1xAuthBackendOtherRequestsToSupplicant	Port-based: Counts the number of times that the switch sends an EAP Request packet following the first to the supplicant. Indicates that the backend server chose an EAP-method. MAC-based: Not applicable.	Rx	Auth. Successes	dot1xAuthBackendAuthSuccesses	Port- and MAC-based: Counts the number of times that the switch receives a success indication. Indicates that the supplicant/client has successfully authenticated to the backend server.	Rx	Auth. Failures	dot1xAuthBackendAuthFails	Port- and MAC-based: Counts the number of times that the switch receives a failure message. This indicates that the supplicant/client has not authenticated to the backend server.	Tx	Responses	dot1xAuthBackendResponses	Port-based: Counts the number of times that the switch attempts to send a supplicant's first response packet to the backend server. Indicates the switch attempted communication with the backend server. Possible retransmissions are not counted. MAC-based: Counts all the backend server packets sent from the switch towards the backend server for a given port (left-most table) or client (right-most table). Possible retransmissions are not counted.
Backend Server Counters																													
Direction	Name	IEEE Name	Description																										
Rx	Access Challenges	dot1xAuthBackendAccessChallenges	Port-based: Counts the number of times that the switch receives the first request from the backend server following the first response from the supplicant. Indicates that the backend server has communication with the switch. MAC-based: Counts all Access Challenges received from the backend server for this port (left-most table) or client (right-most table).																										
Rx	Other Requests	dot1xAuthBackendOtherRequestsToSupplicant	Port-based: Counts the number of times that the switch sends an EAP Request packet following the first to the supplicant. Indicates that the backend server chose an EAP-method. MAC-based: Not applicable.																										
Rx	Auth. Successes	dot1xAuthBackendAuthSuccesses	Port- and MAC-based: Counts the number of times that the switch receives a success indication. Indicates that the supplicant/client has successfully authenticated to the backend server.																										
Rx	Auth. Failures	dot1xAuthBackendAuthFails	Port- and MAC-based: Counts the number of times that the switch receives a failure message. This indicates that the supplicant/client has not authenticated to the backend server.																										
Tx	Responses	dot1xAuthBackendResponses	Port-based: Counts the number of times that the switch attempts to send a supplicant's first response packet to the backend server. Indicates the switch attempted communication with the backend server. Possible retransmissions are not counted. MAC-based: Counts all the backend server packets sent from the switch towards the backend server for a given port (left-most table) or client (right-most table). Possible retransmissions are not counted.																										
<p>Last Supplicant/Client Info</p>	<p>Information about the last supplicant/client that attempts to authenticate. This information is available for the following administrative states:</p> <ul style="list-style-type: none"> • 802.1X • MAC-based Auth. <table border="1"> <thead> <tr> <th colspan="3">Last Supplicant/Client Info</th> </tr> <tr> <th>Name</th> <th>IEEE Name</th> <th>Description</th> </tr> </thead> <tbody> <tr> <td>MAC Address</td> <td>dot1xAuthLastEapolFrameSource</td> <td>The MAC address of the last supplicant/client.</td> </tr> <tr> <td>VLAN ID</td> <td>-</td> <td>The VLAN ID on which the last frame from the last supplicant/client was received. 802.1X-based: The protocol version number carried in the most recently received EAPOL frame.</td> </tr> <tr> <td>Version</td> <td>dot1xAuthLastEapolFrameVersion</td> <td>MAC-based: Not applicable. 802.1X-based: The user name (supplicant identity) carried in the most recently received Response Identity EAPOL frame.</td> </tr> <tr> <td>Identity</td> <td>-</td> <td>MAC-based: Not applicable.</td> </tr> </tbody> </table>	Last Supplicant/Client Info			Name	IEEE Name	Description	MAC Address	dot1xAuthLastEapolFrameSource	The MAC address of the last supplicant/client.	VLAN ID	-	The VLAN ID on which the last frame from the last supplicant/client was received. 802.1X-based: The protocol version number carried in the most recently received EAPOL frame.	Version	dot1xAuthLastEapolFrameVersion	MAC-based: Not applicable. 802.1X-based: The user name (supplicant identity) carried in the most recently received Response Identity EAPOL frame.	Identity	-	MAC-based: Not applicable.										
Last Supplicant/Client Info																													
Name	IEEE Name	Description																											
MAC Address	dot1xAuthLastEapolFrameSource	The MAC address of the last supplicant/client.																											
VLAN ID	-	The VLAN ID on which the last frame from the last supplicant/client was received. 802.1X-based: The protocol version number carried in the most recently received EAPOL frame.																											
Version	dot1xAuthLastEapolFrameVersion	MAC-based: Not applicable. 802.1X-based: The user name (supplicant identity) carried in the most recently received Response Identity EAPOL frame.																											
Identity	-	MAC-based: Not applicable.																											

5.9 Alerts

5.9.1 Fault Alarm

When any selected fault event happens, the Fault LED on the switch panel will light up and the electric relay will signal at the same time. The following pages allow you to set up alert conditions based on your needs for individual switch ports, including actions to be taken during disconnection and power failure.

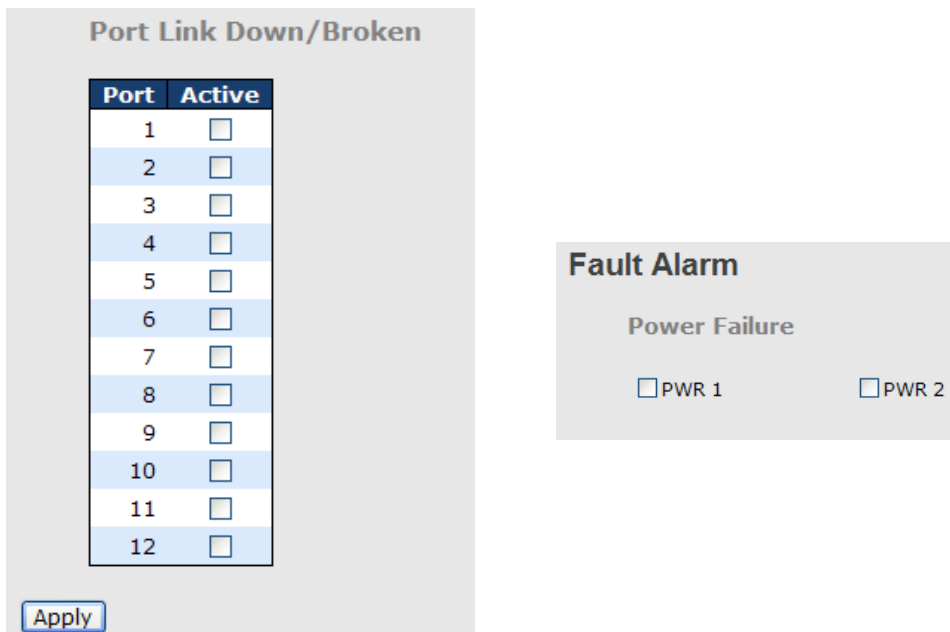

5.9.2 System Warning

SYSLOG Setting

SYSLOG is a protocol that allows a device to send event notification messages across IP networks to event message collectors. It permits separation of the software that generates messages from the system that stores them and the software that reports and analyzes them. As Syslog messages are UDP-based, the sender and receiver will not be aware of it if the packet is lost due to network disconnection and no UDP packet will be resent.

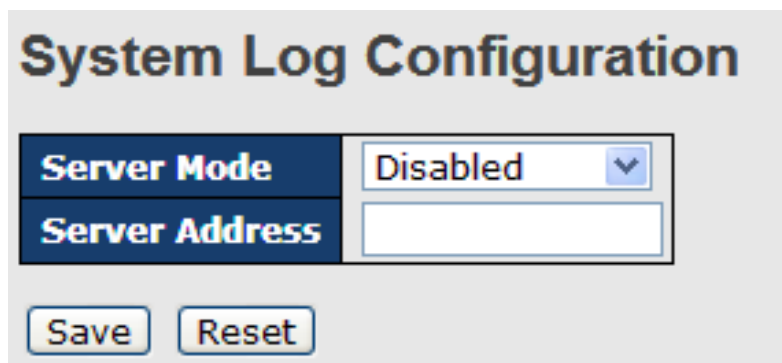

Label	Description
Server Mode	Indicates existing server mode. When the mode operation is enabled, the syslog message will be sent to syslog server. The syslog protocol is based on UDP communications and received on UDP port 514 and the syslog server will not send acknowledgments back to the

	<p>sender since UDP is a connectionless protocol and it does not provide acknowledgments. The syslog packet will always be sent even if the syslog server does not exist.</p> <p>Possible modes are:</p> <p>Enabled: enable server mode</p> <p>Disabled: disable server mode</p>
SYSLOG Server IP Address	Indicates the IPv4 host address of syslog server. If the switch provides DNS functions, it also can be a host name.

SMTP Setting

SMTP (Simple Mail Transfer Protocol) is a protocol for transmitting e-mails across the Internet. By setting up SMTP alert, the device will send a notification e-mail when a user-defined event occurs.

Label	Description
E-mail Alarm	Enables or disables transmission of system warnings by e-mail
Sender E-mail Address	SMTP server IP address
Mail Subject	Subject of the mail
Authentication	<ul style="list-style-type: none"> ■ Username: the authentication username ■ Password: the authentication password ■ Confirm Password: re-enter password
Recipient E-mail	The recipient's e-mail address. A mail allows for 6 recipients.

Address	
Apply	Click to activate the configurations
Help	Shows help file

Event Selection

The device supports both SYSLOG and SMTP alerts. Check the corresponding box to enable the system event warning method you want. Please note that the checkboxes will gray out if SYSLOG or SMTP is disabled.

System Warning - Event Selection

System Events	SYSLOG	SMTP
System Start	<input type="checkbox"/>	<input type="checkbox"/>
Power Status	<input type="checkbox"/>	<input type="checkbox"/>
SNMP Authentication Failure	<input type="checkbox"/>	<input type="checkbox"/>
Redundant Ring Topology Change	<input type="checkbox"/>	<input type="checkbox"/>

Port	SYSLOG	SMTP
1	Disabled	Link Up and Link Down
2	Disabled	Link Up
3	Disabled	Link Down
4	Disabled	Disabled
5	Disabled	Disabled
6	Disabled	Disabled
7	Disabled	Disabled
8	Disabled	Disabled
9	Disabled	Disabled
10	Disabled	Disabled
11	Disabled	Disabled
12	Disabled	Disabled

Label	Description
System Cold Start	Sends out alerts when the system is restarted
Power Status	Sends out alerts when power is up or down
SNMP Authentication Failure	Sends out alert when SNMP authentication fails
O-Ring Topology Change	Sends out alerts when O-Ring topology changes
Port Event SYSLOG / SMTP event	<ul style="list-style-type: none"> ■ Disable ■ Link Up ■ Link Down

	<ul style="list-style-type: none"> ■ Link Up & Link Down
Apply	Click to activate the configurations
Help	Shows help file

5.10 Monitor and Diag

5.10.1 MAC Table

A MAC address tablet is a table in a network switch that maps MAC addresses to ports. The switch uses the table to determine which port the incoming packet should be forwarded to. Entries in a MAC address table fall into two types: dynamic and static entries. Entries in a static MAC table are added or removed manually and cannot age out by themselves. Entries in a dynamic MAC tablet will age out after a configured aging time. Such entries can be added by learning or manual configuration.

MAC Address Table Configuration

Aging Configuration

Disable Automatic Aging	<input type="checkbox"/>
Age Time	300 seconds

MAC Table Learning

	Port Members											
	1	2	3	4	5	6	7	8	9	10	11	12
Auto	<input checked="" type="radio"/>	<input checked="" type="radio"/>	<input checked="" type="radio"/>	<input checked="" type="radio"/>	<input checked="" type="radio"/>	<input checked="" type="radio"/>	<input checked="" type="radio"/>	<input checked="" type="radio"/>	<input checked="" type="radio"/>	<input checked="" type="radio"/>	<input checked="" type="radio"/>	<input checked="" type="radio"/>
Disable	<input type="radio"/>	<input type="radio"/>	<input type="radio"/>	<input type="radio"/>	<input type="radio"/>	<input type="radio"/>	<input type="radio"/>	<input type="radio"/>	<input type="radio"/>	<input type="radio"/>	<input type="radio"/>	<input type="radio"/>
Secure	<input checked="" type="radio"/>	<input type="radio"/>	<input type="radio"/>	<input type="radio"/>	<input type="radio"/>	<input type="radio"/>	<input type="radio"/>	<input type="radio"/>	<input type="radio"/>	<input type="radio"/>	<input type="radio"/>	<input type="radio"/>

Static MAC Table Configuration

			Port Members											
Delete	VLAN ID	MAC Address	1	2	3	4	5	6	7	8	9	10	11	12
<input type="checkbox"/>	1	00-1E-94-98-89-89	<input checked="" type="checkbox"/>	<input type="checkbox"/>	<input type="checkbox"/>	<input type="checkbox"/>	<input type="checkbox"/>	<input type="checkbox"/>	<input type="checkbox"/>	<input type="checkbox"/>	<input type="checkbox"/>	<input type="checkbox"/>	<input type="checkbox"/>	<input type="checkbox"/>

Aging Configuration

Aging enables the switch to track only active MAC addresses on the network and flush out MAC addresses that are no longer used, thereby keeping the table current. By default, aged entries are removed after 300 seconds. You can configure aging time by entering a value in the **Age Time** box in seconds. The allowed range is 10 to 1000000 seconds. You can also disable

the automatic aging of dynamic entries by checking **Disable Automatic Aging**.

MAC Table Learning

The switch can add the address and port on which the packet was received to the MAC table if the address does not exist in the table by examining the source address of each packet received on a port. This is called learning. It allows the MAC table to expand dynamically. If the learning mode for a given port is grayed out, it means another module is in control of the mode, and thus the user cannot change the configurations. An example of such a module is MAC-Based authentication under 802.1X.

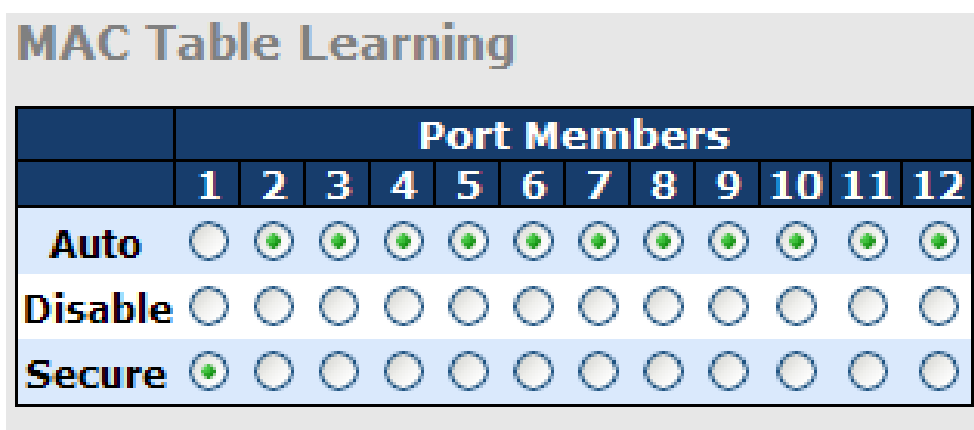

Label	Description
Auto	Learning is done automatically as soon as a frame with unknown SMAC is received.
Disable	No learning is done.
Secure	Only static MAC entries are learned, all other frames are dropped. Note: make sure the link used for managing the switch is added to the static Mac table before changing to secure learning mode, otherwise the management link will be lost and can only be restored by using another non-secure port or by connecting to the switch via the serial interface.

Static MAC Table Configurations

This tablet shows the static entries in the MAC table which can contain up to 64 entries. Using static MAC address entries can reduce broadcast packets remarkably and are suitable for networks where network devices seldom change. You can manage the entries in this page. The MAC table is sorted first by VLAN ID and then by MAC address.

Static MAC Table Configuration

Delete	VLAN ID	MAC Address	Port Members												
			1	2	3	4	5	6	7	8	9	10	11	12	
<input type="checkbox"/>	1	00-1E-94-98-89-89	<input checked="" type="checkbox"/>	<input type="checkbox"/>	<input type="checkbox"/>	<input type="checkbox"/>	<input type="checkbox"/>	<input type="checkbox"/>	<input type="checkbox"/>	<input type="checkbox"/>	<input type="checkbox"/>	<input type="checkbox"/>	<input type="checkbox"/>	<input type="checkbox"/>	<input type="checkbox"/>
<input type="button" value="Delete"/>	<input type="text" value="1"/>	<input type="text" value="00-00-00-00-00-00"/>	<input type="checkbox"/>	<input type="checkbox"/>	<input type="checkbox"/>	<input type="checkbox"/>	<input type="checkbox"/>	<input type="checkbox"/>	<input type="checkbox"/>	<input type="checkbox"/>	<input type="checkbox"/>	<input type="checkbox"/>	<input type="checkbox"/>	<input type="checkbox"/>	<input type="checkbox"/>
<input type="button" value="Delete"/>	<input type="text" value="1"/>	<input type="text" value="00-00-00-00-00-00"/>	<input type="checkbox"/>	<input type="checkbox"/>	<input type="checkbox"/>	<input type="checkbox"/>	<input type="checkbox"/>	<input type="checkbox"/>	<input type="checkbox"/>	<input type="checkbox"/>	<input type="checkbox"/>	<input type="checkbox"/>	<input type="checkbox"/>	<input type="checkbox"/>	<input type="checkbox"/>

Label	Description
Delete	Check to delete an entry. It will be deleted during the next save.
VLAN ID	The VLAN ID for the entry
MAC Address	The MAC address for the entry
Port Members	Checkmarks indicate which ports are members of the entry. Check or uncheck to modify the entry.
Adding New Static Entry	Click to add a new entry to the static MAC table. You can specify the VLAN ID, MAC address, and port members for the new entry. Click Save to save the changes.

MAC Table

Each page shows up to 999 entries from the MAC table, with a default value of 20, selected by the **Entries Per Page** input field. When first visited, the web page will show the first 20 entries from the beginning of the MAC Table. The first displayed will be the one with the lowest VLAN ID and the lowest MAC address found in the MAC Table.

The **Start from MAC address** and **VLAN** fields allow the user to select the starting point in the MAC table. Clicking **Refresh** will update the displayed table starting from that or the closest next MAC table match. In addition, the two input fields will – upon clicking **Refresh** - assume the value of the first displayed entry, allows for continuous refresh with the same start address. The **>>** button will use the last entry of the currently displayed VLAN/MAC address pairs as a basis for the next lookup. When it reaches the end, the text "**no more entries**" is shown in the displayed table. Use the **|<<** button to start over.

MAC Address Table

Auto-refresh Refresh Clear |<< >>

Start from VLAN and MAC address with entries per page.

Type	VLAN	MAC Address	Port Members														
			CPU	1	2	3	4	5	6	7	8	9	10	11	12		
Static	1	00-1E-94-98-89-89		✓													
Static	1	00-1E-94-FF-FF-FF	✓														
Static	1	01-80-C2-4A-44-06	✓	✓	✓	✓	✓	✓	✓	✓	✓	✓	✓	✓	✓	✓	✓
Static	1	33-33-FF-A8-0A-01	✓														
Static	1	33-33-FF-FF-FF-FF	✓														
Static	1	FF-FF-FF-FF-FF-FF	✓	✓	✓	✓	✓	✓	✓	✓	✓	✓	✓	✓	✓	✓	✓

Label	Description
Type	Indicates whether the entry is a static or dynamic entry
MAC address	The MAC address of the entry
VLAN	The VLAN ID of the entry
Port Members	The ports that are members of the entry.

5.10.2 Port Statistics

Traffic Overview

This page provides an overview of general traffic statistics for all switch ports.

Port Statistics Overview

Auto-refresh Refresh Clear

Port	Packets		Bytes		Errors		Drops		Filtered
	Receive	Transmit	Receive	Transmit	Receive	Transmit	Receive	Transmit	Receive
1	117980	86946125	9117790	6259918088	3	0	0	0	0
2	0	0	0	0	0	0	0	0	0
3	68732984	68732987	4957477714	4957477932	0	0	0	0	24710409
4	0	0	0	0	0	0	0	0	0
5	0	0	0	0	0	0	0	0	0
6	68732985	68732987	4957477883	4957477932	1	0	0	0	25204638
7	0	0	0	0	0	0	0	0	0
8	0	0	0	0	0	0	0	0	0
9	0	0	0	0	0	0	0	0	0
10	0	0	0	0	0	0	0	0	0
11	0	0	0	0	0	0	0	0	0
12	0	0	0	0	0	0	0	0	0

Label	Description
Port	The switch port number to which the following settings will be applied.
Packets	The number of received and transmitted packets per port
Bytes	The number of received and transmitted bytes per port

Errors	The number of frames received in error and the number of incomplete transmissions per port
Drops	The number of frames discarded due to ingress or egress congestion
Filtered	The number of received frames filtered by the forwarding process
Auto-refresh	Check to enable an automatic refresh of the page at regular intervals.
Refresh	Updates the counter entries, starting from the current entry ID.
Clear	Flushes all counters entries

Detailed Statistics

This page provides detailed traffic statistics for a specific switch port. Use the port drop-down list to decide the details of which switch port to be displayed.

The displayed counters include the total number for receive and transmit, the size for receive and transmit, and the errors for receive and transmit.

Detailed Statistics – Total Receive & Transmit

Detailed Port Statistics Port 1			
Port 1 <input type="button" value="v"/>		Auto-refresh <input type="checkbox"/>	
		<input type="button" value="Refresh"/> <input type="button" value="Clear"/>	
Receive Total		Transmit Total	
Rx Packets	0	Tx Packets	0
Rx Octets	0	Tx Octets	0
Rx Unicast	0	Tx Unicast	0
Rx Multicast	0	Tx Multicast	0
Rx Broadcast	0	Tx Broadcast	0
Rx Pause	0	Tx Pause	0
Receive Size Counters		Transmit Size Counters	
Rx 64 Bytes	0	Tx 64 Bytes	0
Rx 65-127 Bytes	0	Tx 65-127 Bytes	0
Rx 128-255 Bytes	0	Tx 128-255 Bytes	0
Rx 256-511 Bytes	0	Tx 256-511 Bytes	0
Rx 512-1023 Bytes	0	Tx 512-1023 Bytes	0
Rx 1024-1526 Bytes	0	Tx 1024-1526 Bytes	0
Rx 1527- Bytes	0	Tx 1527- Bytes	0
Receive Queue Counters		Transmit Queue Counters	
Rx Q0	0	Tx Q0	0
Rx Q1	0	Tx Q1	0
Rx Q2	0	Tx Q2	0
Rx Q3	0	Tx Q3	0
Rx Q4	0	Tx Q4	0
Rx Q5	0	Tx Q5	0
Rx Q6	0	Tx Q6	0
Rx Q7	0	Tx Q7	0
Receive Error Counters		Transmit Error Counters	
Rx Drops	0	Tx Drops	0
Rx CRC/Alignment	0	Tx Late/Exc. Coll.	0
Rx Undersize	0		
Rx Oversize	0		
Rx Fragments	0		
Rx Jabber	0		
Rx Filtered	0		

Label	Description
Rx and Tx Packets	The number of received and transmitted (good and bad) packets
Rx and Tx Octets	The number of received and transmitted (good and bad) bytes, including FCS, except framing bits
Rx and Tx Unicast	The number of received and transmitted (good and bad) unicast packets
Rx and Tx Multicast	The number of received and transmitted (good and bad) multicast packets
Rx and Tx Broadcast	The number of received and transmitted (good and bad) broadcast packets
Rx and Tx Pause	The number of MAC Control frames received or transmitted on this port that have an opcode indicating a PAUSE operation
Rx Drops	The number of frames dropped due to insufficient receive buffer or egress congestion
Rx CRC/Alignment	The number of frames received with CRC or alignment errors
Rx Undersize	The number of short ¹ frames received with a valid CRC
Rx Oversize	The number of long ² frames received with a valid CRC
Rx Fragments	The number of short ¹ frames received with an invalid CRC
Rx Jabber	The number of long ² frames received with an invalid CRC
Rx Filtered	The number of received frames filtered by the forwarding process
Tx Drops	The number of frames dropped due to output buffer congestion
Tx Late / Exc.Coll.	The number of frames dropped due to excessive or late collisions

1. Short frames are frames smaller than 64 bytes.
2. Long frames are frames longer than the maximum frame length configured for this port.

5.10.3 Port Mirroring

Port mirroring function will copy the traffic of one port to another port on the same switch to allow the network analyzer attached to the mirror port to monitor and analyze packets. The function is useful for troubleshooting. To solve network problems, selected traffic can be copied or mirrored to a mirror port where a frame analyzer can be attached to analyze the frame flow. The traffic to be copied to the mirror port can be all frames received on a given port (also known as ingress or source mirroring) or all frames transmitted on a given port (also known as egress or destination mirroring). The port to which the monitored traffic is copied is called mirror port.

Mirror Configuration

Port to mirror to Disabled ▾

Port	Mode
1	Disabled ▾
2	Disabled ▾
3	Disabled ▾
4	Disabled ▾
5	Disabled ▾
6	Disabled ▾
7	Disabled ▾
8	Disabled ▾
9	Disabled ▾
10	Disabled ▾
11	Disabled ▾

Label	Description
Port	The switch port number to which the following settings will be applied.
Mode	<p>Drop-down list for selecting a mirror mode.</p> <p>Rx only: only frames received on this port are mirrored to the mirror port. Frames transmitted are not mirrored.</p> <p>Tx only: only frames transmitted from this port are mirrored to the mirror port. Frames received are not mirrored.</p> <p>Disabled: neither transmitted nor received frames are mirrored.</p> <p>Enabled: both received and transmitted frames are mirrored to the mirror port.</p> <p>Note: for a given port, a frame is only transmitted once. Therefore, you cannot mirror Tx frames to the mirror port. In this case, mode for the selected mirror port is limited to Disabled or Rx only.</p>

5.10.4 System Log Information

This page provides switch system log information.

System Log Information

Auto-refresh Refresh Clear |<< << >> >>| Open in new window

Level All

The total number of entries is 1 for the given level.

Start from ID with entries per page.

ID	Level	Time	Message
	Info	1970-01-01 00:01:09 +0000	Port. 1 Device(192.168.10.66): Alive Check got reply again.

Label	Description
ID	The ID (≥ 1) of the system log entry
Level	The level of the system log entry. The following level types are supported: Info: provides general information Warning: provides warning for abnormal operation Error: provides error message All: enables all levels
Time	The time of the system log entry
Message	The MAC address of the switch
Auto-refresh	Check this box to enable an automatic refresh of the page at regular intervals.
Refresh	Updates system log entries, starting from the current entry ID
Clear	Flushes all system log entries
<<	Updates system log entries, starting from the first available entry ID
<<	Updates system log entries, ending at the last entry currently displayed
>>	Updates system log entries, starting from the last entry currently displayed.
>>	Updates system log entries, ending at the last available entry ID.

5.10.5 Cable Diagnostics

You can perform cable diagnostics for all ports or selected ports to diagnose any cable faults (short, open etc.) and feedback a distance to the fault. Simply select the port from the drop-down list and click **Start** to run the diagnostics. This will take approximately 5 seconds. If all ports are selected, this can take approximately 15 seconds. When completed, the page refreshes automatically, and you can view the cable diagnostics results in the cable status

table. Note that VeriPHY diagnostics is only accurate for cables 7 - 140 meters long. 10 and 100 Mbps ports will be disconnected while running VeriPHY diagnostics. Therefore, running VeriPHY on a 10 or 100 Mbps management port will cause the switch to stop responding until VeriPHY is completed.

VeriPHY Cable Diagnostics

Port

Cable Status								
Port	Pair A	Length A	Pair B	Length B	Pair C	Length C	Pair D	Length D
1	--	--	--	--	--	--	--	--
2	--	--	--	--	--	--	--	--
3	--	--	--	--	--	--	--	--
4	--	--	--	--	--	--	--	--
5	--	--	--	--	--	--	--	--
6	--	--	--	--	--	--	--	--
7	--	--	--	--	--	--	--	--
8	--	--	--	--	--	--	--	--

Label	Description
Port	The port where you are requesting VeriPHY Cable Diagnostics
Cable Status	Port: port number Pair: the status of the cable pair Length: the length (in meters) of the cable pair

5.10.6 SFP Monitor

SFP modules with DDM (Digital Diagnostic Monitoring) function can measure the temperature of the apparatus, helping you monitor the status of connection and detect errors immediately. You can manage and set up event alarms through DDM Web interface.

SFP Monitor

Auto-refresh Refresh

Port No.	Temperature (°C)	Vcc (V)	TX Bias(mA)	TX Power(μW)	RX Power(μW)
1	N/A	N/A	N/A	N/A	N/A
2	N/A	N/A	N/A	N/A	N/A
3	N/A	N/A	N/A	N/A	N/A
4	N/A	N/A	N/A	N/A	N/A
5	N/A	N/A	N/A	N/A	N/A
6	N/A	N/A	N/A	N/A	N/A
7	N/A	N/A	N/A	N/A	N/A
8	N/A	N/A	N/A	N/A	N/A
9	N/A	N/A	N/A	N/A	N/A
10	N/A	N/A	N/A	N/A	N/A
11	N/A	N/A	N/A	N/A	N/A
12	N/A	N/A	N/A	N/A	N/A

Warning Temperature :

°C(0~100)

Event Alarm :

Syslog

5.10.7 Ping

This command sends ICMP echo request packets to another node on the network. Using the ping command, you can see if another site on the network can be reached.

ICMP Ping

IP Address	0.0.0.0
Ping Size	64

After you press **Start**, five ICMP packets will be transmitted, and the sequence number and roundtrip time will be displayed upon reception of a reply. The page refreshes automatically until responses to all packets are received, or until a timeout occurs.

```

PING6 server ::10.10.132.20
64 bytes from ::10.10.132.20: icmp_seq=0, time=0ms
64 bytes from ::10.10.132.20: icmp_seq=1, time=0ms
64 bytes from ::10.10.132.20: icmp_seq=2, time=0ms
64 bytes from ::10.10.132.20: icmp_seq=3, time=0ms
64 bytes from ::10.10.132.20: icmp_seq=4, time=0ms
    
```

Sent 5 packets, received 5 OK, 0 bad

You can configure the following properties of the issued ICMP packets:

Label	Description
IP Address	The destination IP Address
Ping Size	The payload size of the ICMP packet. Values range from 8 to 1400 bytes.

IPv6 Ping

PING6 server ::192.168.10.1

sendto
sendto
sendto
sendto
sendto

Sent 5 packets, received 0 OK, 0 bad

5.11 Synchronization

PTP External Clock Mode

PTP External Clock Mode is a protocol for synchronizing clocks throughout a computer network. On a local area network, it achieves clock accuracy in the sub-microsecond range, making it suitable for measurement and control systems.

Label	Description
One_pps_mode	The box allows you to select One_pps_mode configurations. The following values are possible: Output: enable the 1 pps clock output Input: enable the 1 pps clock input Disable: disable the 1 pps clock in/out-put
External Enable	The box allows you to configure external clock output. The following values are possible: True: enable external clock output False: disable external clock output
VCXO_Enable	The box allows you to configure the external VCXO rate adjustment. The following values are possible: True: enable external VCXO rate adjustment False: disable external VCXO rate adjustment
Clock Frequency	The box allows you to set clock frequency. The range of values is 1 - 25000000 (1 - 25MHz).

PTP Clock Configurations

PTP Clock Configuration

			Port List																			
Delete	Clock Instance	Device Type	1	2	3	4	5	6	7	8	9	10	11	12	13	14	15	16	17	18	19	20
No Clock Instances Present																						

Add New PTP Clock
Save
Reset

Label	Description
Delete	Check this box and click Save to delete the clock instance
Clock Instance	Indicates the instance of a particular clock instance [0..3] Click on the clock instance number to edit the clock details
Device Type	Indicates the type of the clock instance. There are five device types. Ord-Bound: ordinary/boundary clock P2p Transp: peer-to-peer transparent clock E2e Transp: end-to-end transparent clock

	<p>Master Only: master only</p> <p>Slave Only: slave only</p>
Port List	Set check mark for each port configured for this Clock Instance.
2 Step Flag	Static member defined by the system; true if two-step Sync events and Pdelay_Resp events are used
Clock Identity	Shows a unique clock identifier
One Way	If true , one-way measurements are used. This parameter applies only to a slave. In one-way mode no delay measurements are performed, i.e. this is applicable only if frequency synchronization is needed. The master always responds to delay requests.
Protocol	<p>Transport protocol used by the PTP protocol engine</p> <p>Ethernet PTP over Ethernet multicast</p> <p>ip4multi PTP over IPv4 multicast</p> <p>ip4uni PTP over IPv4 unicast</p> <p>Note: IPv4 unicast protocol only works in Master Only and Slave Only clocks</p> <p>For more information, please refer to Device Type.</p> <p>In a unicast Slave Only clock, you also need to configure which master clocks to request Announce and Sync messages from.</p> <p>For more information, please refer to Unicast Slave Configuration</p>
VLAN Tag Enable	<p>Enables VLAN tagging for PTP frames</p> <p>Note: Packets are only tagged if the port is configured for vlan tagging. i.e:</p> <p>Port Type != Unaware and PortVLAN mode == None, and the port is member of the VLAN.</p>
VID	VLAN identifiers used for tagging the PTP frames
PCP	Priority code point values used for PTP frames

5.12 Troubleshooting

5.12.1 Factory Defaults

This function is to force the switch back to the original factory settings. To reset the switch, select **Reset to Factory Defaults** from the drop-down list and click **Yes**. Only the IP configuration is retained.

Factory Defaults

Are you sure you want to reset the configuration to Factory Defaults?

Label	Description
Yes	Click to reset the configuration to factory defaults
No	Click to return to the Port State page without resetting

5.12.2 System Reboot

You can reset the stack switch on this page. After reset, the system will boot normally as if you have powered on the devices.

Warm Reset

Are you sure you want to perform a Warm Restart?

Label	Description
Yes	Click to reboot device
No	Click to return to the Port State page without rebooting

Command Line Management

Besides Web-based management, the device also supports CLI management. You can use console or telnet to manage the switch by CLI.

CLI Management by RS-232 Serial Console (115200, 8, none, 1, none)

Before configuring RS-232 serial console, connect the RS-232 port of the switch to your PC Com port using a RJ45 to DB9-F cable.

Follow the steps below to access the console via RS-232 serial cable.

Step 1: On Windows desktop, click on **Start -> Programs -> Accessories -> Communications -> Hyper Terminal**

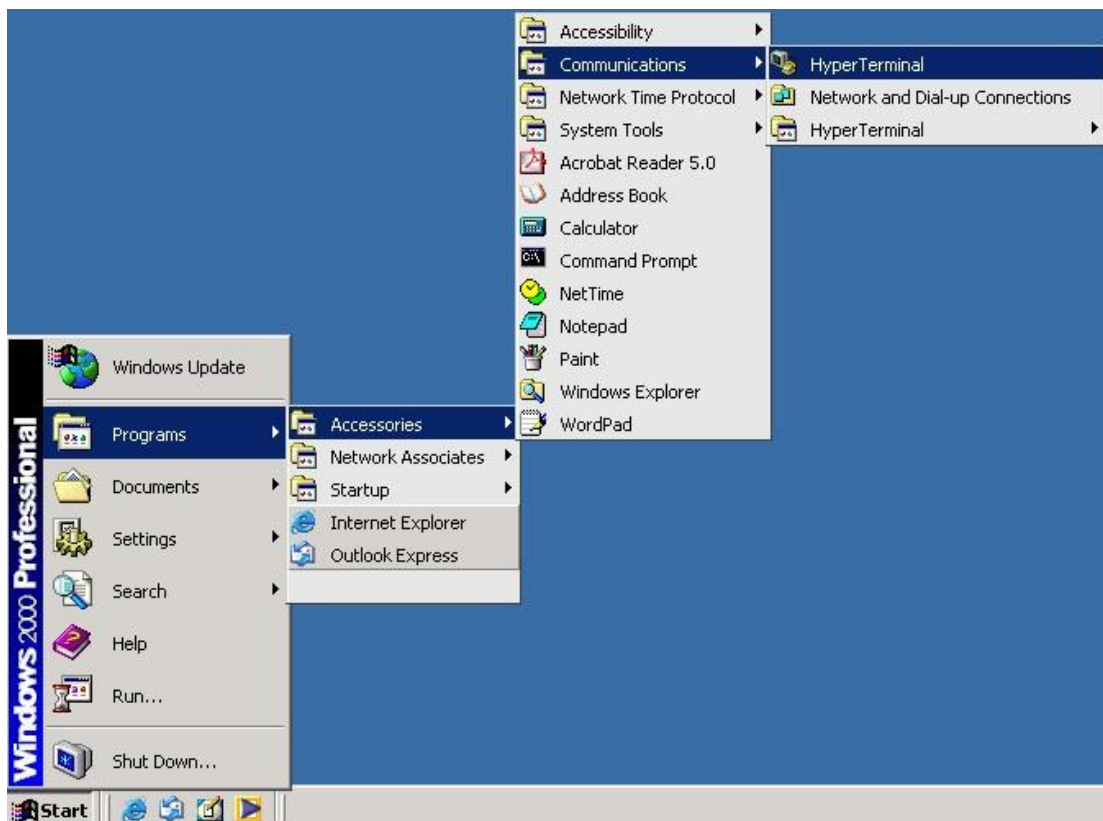

Step 2. Input a name for the new connection.

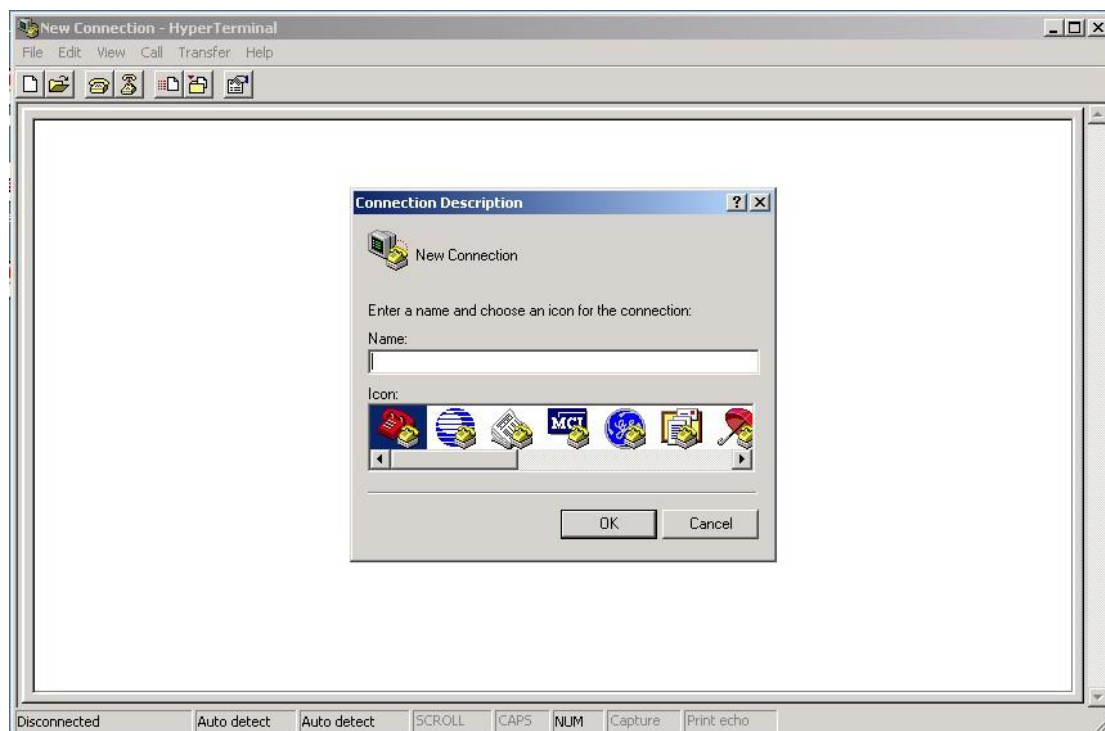

Step 3. Select a COM port in the drop-down list.

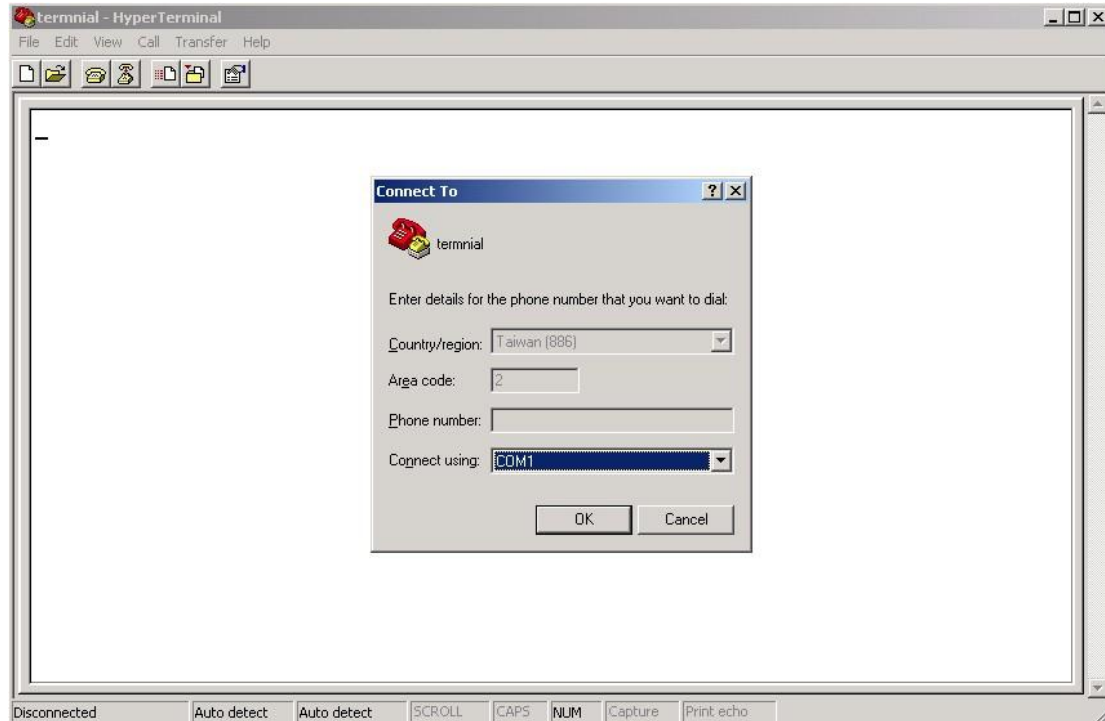

Step 4. A pop-up window that indicates COM port properties appears, including bits per second, data bits, parity, stop bits, and flow control.

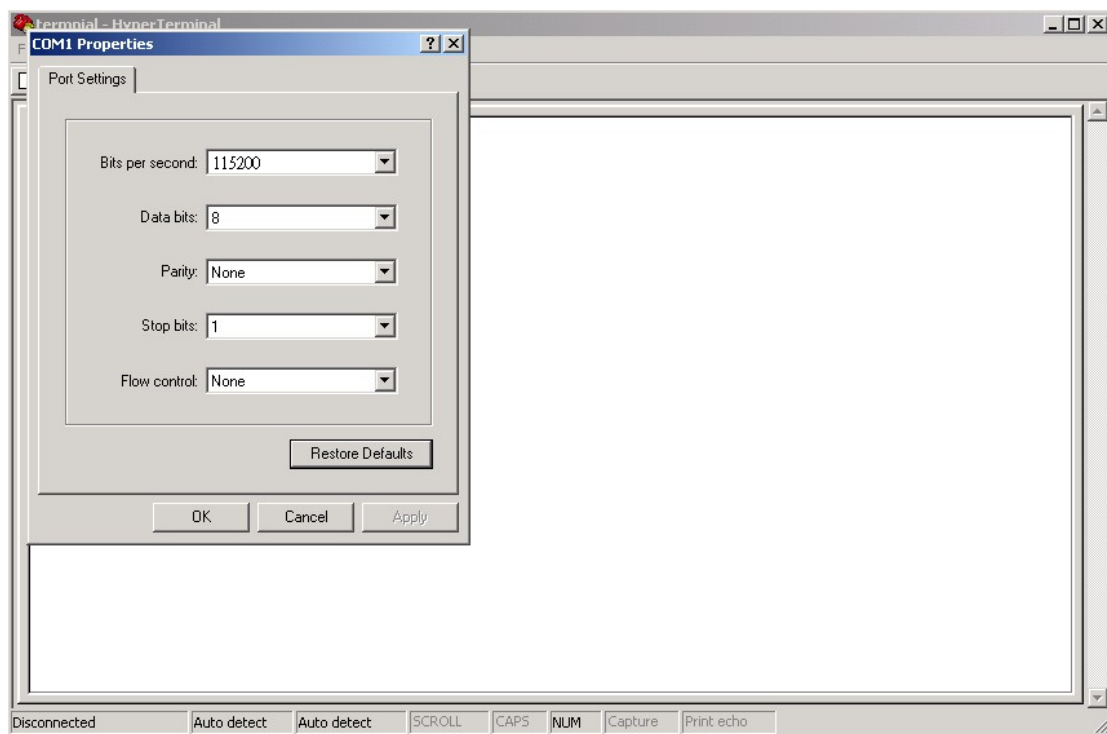

Step 5. The console login screen will appear. Use the keyboard to enter the Username and Password (same as the password for Web browsers), then press **Enter**.

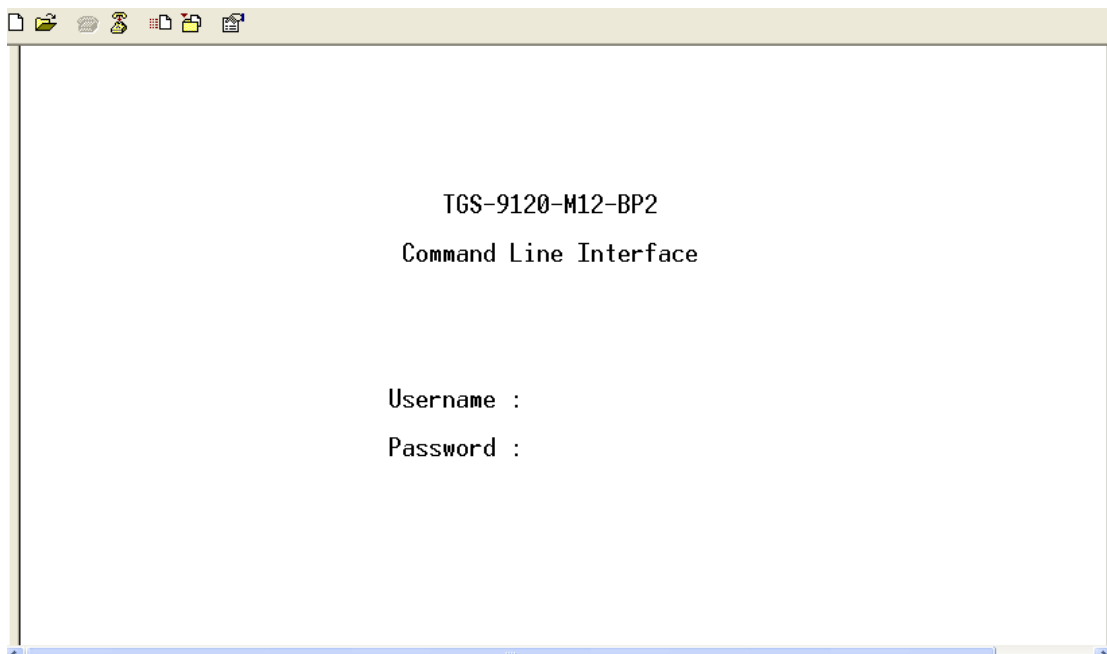

CLI Management by Telnet

You can use **TELNET** to configure the switch. The default values are:

IP Address: **192.168.10.1**

Subnet Mask: **255.255.255.0**

Default Gateway: **192.168.10.254**

User Name: **admin**

Password: **admin**

Follow the steps below to access console via Telnet.

Step 1. Telnet to the IP address of the switch from the **Run** window by inputting commands (or from the MS-DOS prompt) as below.

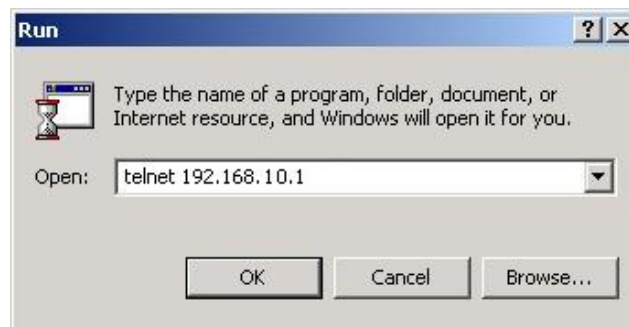

Step 2. The Login screen will appear. Use the keyboard to enter the Username and Password (same as the password for Web browser), and then press **Enter**.

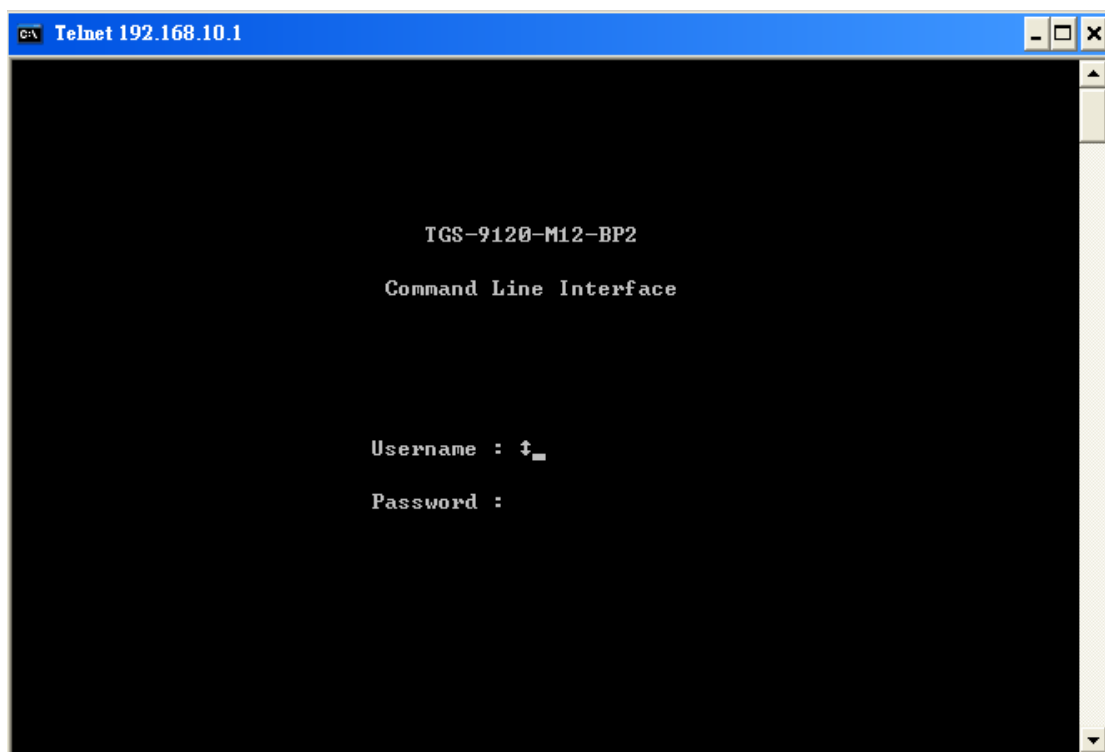

Commander Groups

```
Command Groups:
-----
System      : System settings and reset options
IP          : IP configuration and Ping
Port        : Port management
MAC         : MAC address table
VLAN        : Virtual LAN
PULAN       : Private VLAN
Security    : Security management
STP         : Spanning Tree Protocol
Aggr        : Link Aggregation
LACP        : Link Aggregation Control Protocol
LLDP        : Link Layer Discovery Protocol
PoE         : Power Over Ethernet
QoS         : Quality of Service
Mirror      : Port mirroring
Config      : Load/Save of configuration via TFTP
Firmware    : Download of firmware via TFTP
PTP         : IEEE1588 Precision Time Protocol
Loop Protect : Loop Protection
IPMC        : MLD/IGMP Snooping
Fault       : Fault Alarm Configuration
Event       : Event Selection
DHCP Server : DHCP Server Configuration
Ring        : Ring Configuration
Chain       : Chain Configuration
RCS         : Remote Control Security
Fastrecovery : Fast-Recovery Configuration
SFP         : SFP Monitor Configuration
DeviceBinding : Device Binding Configuration
MRP         : MRP Configuration
Modbus      : Modbus TCP Configuration
```

System

System>	Configuration [all] [<port_list>]
	Reboot
	Restore Default [keep_ip]
	Contact [<contact>]
	Name [<name>]
	Location [<location>]
	Description [<description>]
	Password <password>
	Username [<username>]
	Timezone [<offset>]
	Log [<log_id>] [all info warning error] [clear]

IP

IP>	Configuration
	DHCP [enable disable]
	Setup [<ip_addr>] [<ip_mask>] [<ip_router>] [<vid>]
	Ping <ip_addr_string> [<ping_length>]
	SNTP [<ip_addr_string>]

Port

port>	Configuration [<port_list>] [up down]
	Mode [<port_list>] [auto 10hdx 10fdx 100hdx 100fdx 1000fdx sfp_auto_ams]
	Flow Control [<port_list>] [enable disable]
	State [<port_list>] [enable disable]
	MaxFrame [<port_list>] [<max_frame>]
	Power [<port_list>] [enable disable actiphy dynamic]
	Excessive [<port_list>] [discard restart]
	Statistics [<port_list>] [<command>] [up down]
	VeriPHY [<port_list>]
	SFP [<port_list>]

MAC

MAC>	Configuration [<port_list>]
	Add <mac_addr> <port_list> [<vid>]
	Delete <mac_addr> [<vid>]

	Lookup <mac_addr> [<vid>]
	Agetime [<age_time>]
	Learning [<port_list>] [auto disable secure]
	Dump [<mac_max>] [<mac_addr>] [<vid>]
	Statistics [<port_list>]
	Flush

VLAN

	Configuration [<port_list>]
	PVID [<port_list>] [<vid> none]
	FrameType [<port_list>] [all tagged untagged]
	IngressFilter [<port_list>] [enable disable]
	tx_tag [<port_list>] [untag_pvid untag_all tag_all]
	PortType [<port_list>] [unaware c-port s-port s-custom-port]
	EtypeCustomSport [<etype>]
	Add <vid> <name> [<ports_list>]
VLAN>	Forbidden Add <vid> <name> [<port_list>]
	Delete <vid> <name>
	Forbidden Delete <vid> <name>
	Forbidden Lookup [<vid>] [(name <name>)]
	Lookup [<vid>] [(name <name>)] [combined static nas all]
	Name Add <name> <vid>
	Name Delete <name>
	Name Lookup [<name>]
	Status [<port_list>] [combined static nas mstp all conflicts]

Private VLAN

	Configuration [<port_list>]
	Add <pvlan_id> [<port_list>]
PVLAN>	Delete <pvlan_id>
	Lookup [<pvlan_id>]
	Isolate [<port_list>] [enable disable]

Security

Security >	Switch Switch security setting
	Network Network security setting

AAA	Authentication, Authorization and Accounting setting
-----	---

Security Switch

Security/switch>	Password <password>
	Auth Authentication
	SSH Secure Shell
	HTTPS Hypertext Transfer Protocol over Secure Socket Layer
	RMON Remote Network Monitoring

Security Switch Authentication

Security/switch/auth>	Configuration
	Method [console telnet ssh web] [none local radius]
	[enable disable]

Security Switch SSH

Security/switch/ssh>	Configuration
	Mode [enable disable]

Security Switch HTTPS

Security/switch/ssh>	Configuration
	Mode [enable disable]

Security Switch RMON

Security/switch/rmon>	Statistics Add <stats_id> <data_source>
	Statistics Delete <stats_id>
	Statistics Lookup [<stats_id>]
	History Add <history_id> <data_source> [<interval>] [<buckets>]
	History Delete <history_id>
	History Lookup [<history_id>]
	Alarm Add <alarm_id> <interval> <alarm_variable> [absolute delta]<rising_threshold> <rising_event_index> <falling_threshold> <falling_event_index> [rising falling both]
	Alarm Delete <alarm_id>
	Alarm Lookup [<alarm_id>]

Security Network

Security/Network>	Psec	Port Security Status
	NAS	Network Access Server (IEEE 802.1X)
	ACL	Access Control List
	DHCP	Dynamic Host Configuration Protocol

Security Network Psec

Security/Network/Psec>	Switch [<port_list>]
	Port [<port_list>]

Security Network NAS

Security/Network/NAS>	Configuration [<port_list>]
	Mode [enable disable]
	State [<port_list>] [auto authorized unauthorized macbased]
	Reauthentication [enable disable]
	ReauthPeriod [<reauth_period>]
	EapolTimeout [<eapol_timeout>]
	Agetime [<age_time>]
	Holdtime [<hold_time>]
	Authenticate [<port_list>] [now]
	Statistics [<port_list>] [clear eapol radius]

Security Network ACL

Security/Network/ACL>	Configuration [<port_list>]
	Action [<port_list>] [permit deny] [<rate_limiter>][<port_redirect>] [<mirror>] [<logging>] [<shutdown>]
	Policy [<port_list>] [<policy>]
	Rate [<rate_limiter_list>] [<rate_unit>] [<rate>]
	Add [<ace_id>] [<ace_id_next>][<(port <port_list>)>] [<(policy <policy> <policy_bitmask>)>][<tagged>] [<vid>] [<tag_prio>] [<dmac_type>][<(etype [<etype>] [<smac>] [<dmac>])>] (arp [<sip>] [<dip>] [<smac>] [<arp_opcode>] [<arp_flags>]) (ip [<sip>] [<dip>] [<protocol>] [<ip_flags>]) (icmp [<sip>] [<dip>] [<icmp_type>] [<icmp_code>])

	[<ip_flags>)] (udp [<sip>] [<dip>] [<sport>] [<dport>] [<ip_flags>)] (tcp [<sip>] [<dip>] [<sport>] [<dport>] [<ip_flags>] [<tcp_flags>)]) [permit deny] [<rate_limiter>] [<port_redirect>] [<mirror>] [<logging>][<shutdown>]
	Delete <ace_id>
	Lookup [<ace_id>]
	Clear
	Status [combined static loop_protect dhcp ptp ipmc conflicts]
	Port State [<port_list>] [enable disable]

Security Network DHCP

Security/Network/DHCP>	Configuration
	Mode [enable disable]
	Server [<ip_addr>]
	Information Mode [enable disable]
	Information Policy [replace keep drop]
	Statistics [clear]

Security Network AAA

Security/Network/AAA>	Configuration
	Timeout [<timeout>]
	Deadtime [<dead_time>]
	RADIUS [<server_index>] [enable disable] [<ip_addr_string>] [<secret>] [<server_port>]
	ACCT_RADIUS [<server_index>] [enable disable] [<ip_addr_string>] [<secret>] [<server_port>]
	Statistics [<server_index>]

STP

STP>	Configuration
	Version [<stp_version>] Non-certified release, v
	Txhold [<holdcount>]lt 15:15:15, Dec 6 2007

	MaxAge [<max_age>]
	FwdDelay [<delay>]
	bpduFilter [enable disable]
	bpduGuard [enable disable]
	recovery [<timeout>]
	CName [<config-name>] [<integer>]
	Status [<msti>] [<port_list>]
	Msti Priority [<msti>] [<priority>]
	Msti Map [<msti>] [clear]
	Msti Add <msti> <vid>
	Port Configuration [<port_list>]
	Port Mode [<port_list>] [enable disable]
	Port Edge [<port_list>] [enable disable]
	Port AutoEdge [<port_list>] [enable disable]
	Port P2P [<port_list>] [enable disable auto]
	Port RestrictedRole [<port_list>] [enable disable]
	Port RestrictedTcn [<port_list>] [enable disable]
	Port bpduGuard [<port_list>] [enable disable]
	Port Statistics [<port_list>]
	Port Mcheck [<port_list>]
	Msti Port Configuration [<msti>] [<port_list>]
	Msti Port Cost [<msti>] [<port_list>] [<path_cost>]
	Msti Port Priority [<msti>] [<port_list>] [<priority>]

Aggr

Aggr>	Configuration
	Add <port_list> [<aggr_id>]
	Delete <aggr_id>
	Lookup [<aggr_id>]
	Mode [smac dmac ip port] [enable disable]

LACP

LACP>	Configuration [<port_list>]
	Mode [<port_list>] [enable disable]
	Key [<port_list>] [<key>]

	Role [<port_list>] [active passive]
	Status [<port_list>]
	Statistics [<port_list>] [clear]

LLDP

LLDP>	Configuration [<port_list>]
	Mode [<port_list>] [enable disable]
	Statistics [<port_list>] [clear]
	Info [<port_list>]

PoE

PoE>	Configuration [<port_list>]
	Mode [<port_list>] [disabled poe poe+]
	Priority [<port_list>] [low high critical]
	Mgmt_mode [class_con class_res al_con al_res lldp_res lldp_con]
	Maximum_Power [<port_list>] [<port_power>]
	Status
	Primary_Supply [<supply_power>]

QoS

QoS>	DSCP Map [<dscp_list>] [<class>] [<dpl>]
	DSCP Translation [<dscp_list>] [<trans_dscp>]
	DSCP Trust [<dscp_list>] [enable disable]
	DSCP Classification Mode [<dscp_list>] [enable disable]
	DSCP Classification Map [<class_list>] [<dpl_list>] [<dscp>]
	DSCP EgressRemap [<dscp_list>] [<dpl_list>] [<dscp>]
	Storm Unicast [enable disable] [<packet_rate>]
	Storm Multicast [enable disable] [<packet_rate>]
	Storm Broadcast [enable disable] [<packet_rate>]
	QCL Add [<qce_id>] [<qce_id_next>] [<port_list> [<tag>] [<vid>] [<pcp>] [<dei>] [<smac>] [<dmac_type>] [(etype [<etype>]) (LLC [<DSAP>] [<SSAP>] [<control>]) (SNAP [<PID>])

	(ipv4 [<protocol>] [<sip>] [<dscp>] [<fragment>] [<sport>] [<dport>]) (ipv6 [<protocol>] [<sip_v6>] [<dscp>] [<sport>] [<dport>]) [<class>] [<dp>] [<classified_dscp>]
	QCL Delete <qce_id>
	QCL Lookup [<qce_id>]
	QCL Status [combined static conflicts]
	QCL Refresh

Mirror

Mirror>	Configuration [<port_list>]
	Port [<port> disable]
	Mode [<port_list>] [enable disable rx tx]

Dot1x

Dot1x>	Configuration [<port_list>]
	Mode [enable disable]
	State [<port_list>] [macbased auto authorized unauthorized]
	Authenticate [<port_list>] [now]
	Reauthentication [enable disable]
	Period [<reauth_period>]
	Timeout [<eapol_timeout>]
	Statistics [<port_list>] [clear eapol radius]
	Clients [<port_list>] [all <client_cnt>]
	Agetime [<age_time>]
Holdtime [<hold_time>]	

IGMP

IGMP>	Configuration [<port_list>]
	Mode [enable disable]
	State [<vid>] [enable disable]
	Querier [<vid>] [enable disable]
	Fastleave [<port_list>] [enable disable]
	Router [<port_list>] [enable disable]
	Flooding [enable disable]
Groups [<vid>]	

	Status [<vid>]
--	----------------

ACL

	Configuration [<port_list>]
	Action [<port_list>] [permit deny] [<rate_limiter>] [<port_copy>] [<logging>] [<shutdown>]
	Policy [<port_list>] [<policy>]
	Rate [<rate_limiter_list>] [<packet_rate>]
ACL>	Add [<ace_id>] [<ace_id_next>] [switch (port <port>) (policy <policy>)] [<vid>] [<tag_prio>] [<dmac_type>] [(etype [<etype>] [<smac>] [<dmac>]) (arp [<sip>] [<dip>] [<smac>] [<arp_opcode>] [<arp_flags>)] (ip [<sip>] [<dip>] [<protocol>] [<ip_flags>)] (icmp [<sip>] [<dip>] [<icmp_type>] [<icmp_code>] [<ip_flags>]) (udp [<sip>] [<dip>] [<sport>] [<dport>] [<ip_flags>]) (tcp [<sip>] [<dip>] [<sport>] [<dport>] [<ip_flags>] [<tcp_flags>]) [permit deny] [<rate_limiter>] [<port_copy>] [<logging>] [<shutdown>] Delete <ace_id>
	Lookup [<ace_id>]
	Clear

Mirror

Mirror>	Configuration [<port_list>]
	Port [<port> disable]
	Mode [<port_list>] [enable disable rx tx]

Config

Config>	Save <ip_server> <file_name>
	Load <ip_server> <file_name> [check]

Firmware

Firmware >	Load <ip_addr_string> <file_name>
---------------	-----------------------------------

SNMP

SNMP>	Trap Inform Retry Times [<retries>]
	Trap Probe Security Engine ID [enable disable]
	Trap Security Engine ID [<engineid>]
	Trap Security Name [<security_name>]
	Engine ID [<engineid>]
	Community Add <community> [<ip_addr>] [<ip_mask>]
	Community Delete <index>
	Community Lookup [<index>]
	User Add <engineid> <user_name> [MD5 SHA] [<auth_password>] [DES] [<priv_password>]
	User Delete <index>
	User Changekey <engineid> <user_name> <auth_password> [<priv_password>]
	User Lookup [<index>]
	Group Add <security_model> <security_name> <group_name>
	Group Delete <index>
	Group Lookup [<index>]
	View Add <view_name> [included excluded] <oid_subtree>
	View Delete <index>
	View Lookup [<index>]
	Access Add <group_name> <security_model> <security_level> [<read_view_name>] [<write_view_name>]
	Access Delete <index>
	Access Lookup [<index>]

Firmware

Firmware>	Load <ip_addr_string> <file_name>
-----------	-----------------------------------

PTP

PTP>	Configuration [<clockinst>]
	PortState <clockinst> [<port_list>] [enable disable internal]
	ClockCreate <clockinst> [<devtype>] [<twostep>] [<protocol>] [<oneway>] [<clockid>] [<tag_enable>] [<vid>] [<prio>]

	ClockDelete <clockinst> [<devtype>]
	DefaultDS <clockinst> [<priority1>] [<priority2>] [<domain>]
	CurrentDS <clockinst>
	ParentDS <clockinst>
	Timingproperties <clockinst> [<utcoffset>] [<valid>] [<leap59>] [<leap61>] [<timetrac>] [<freqtrac>] [<ptptimescale>] [<timesource>]
	PTP PortDataSet <clockinst> [<port_list>] [<announceintv>] [<announceto>] [<syncintv>] [<delaymech>] [<minpdelayreqintv>] [<delayasymmetry>] [<ingressLatency>]
	LocalClock <clockinst> [update show ratio] [<clockratio>]
	Filter <clockinst> [<def_delay_filt>] [<period>] [<dist>]
	Servo <clockinst> [<displaystates>] [<ap_enable>] [<ai_enable>] [<ad_enable>] [<ap>] [<ai>] [<ad>]
	SlaveTableUnicast <clockinst>
	UniConfig <clockinst> [<index>] [<duration>] [<ip_addr>]
	ForeignMasters <clockinst> [<port_list>]
	EgressLatency [show clear]
	MasterTableUnicast <clockinst>
	ExtClockMode [<one_pps_mode>] [<ext_enable>] [<clockfreq>] [<vcxo_enable>]
	OnePpsAction [<one_pps_clear>]
	DebugMode <clockinst> [<debug_mode>]
	Wireless mode <clockinst> [<port_list>] [enable disable]
	Wireless pre notification <clockinst> <port_list>
	Wireless delay <clockinst> [<port_list>] [<base_delay>] [<incr_delay>]

Loop Protect

Loop Protect>	Configuration
	Mode [enable disable]
	Transmit [<transmit-time>]
	Shutdown [<shutdown-time>]
	Port Configuration [<port_list>]
	Port Mode [<port_list>] [enable disable]
	Port Action [<port_list>] [shutdown shut_log log]

	Port Transmit [<port_list>] [enable disable]
	Status [<port_list>]

IPMC

IPMC>	Configuration [igmp]
	Mode [igmp] [enable disable]
	Flooding [igmp] [enable disable]
	VLAN Add [igmp] <vid>
	VLAN Delete [igmp] <vid>
	State [igmp] [<vid>] [enable disable]
	Querier [igmp] [<vid>] [enable disable]
	Fastleave [igmp] [<port_list>] [enable disable]
	Router [igmp] [<port_list>] [enable disable]
	Status [igmp] [<vid>]
	Groups [igmp] [<vid>]
	Version [igmp] [<vid>]

Fault

Fault>	Alarm PortLinkDown [<port_list>] [enable disable]
	Alarm PowerFailure [pwr1 pwr2 pwr3] [enable disable]

Event

Event>	Configuration
	Syslog SystemStart [enable disable]
	Syslog PowerStatus [enable disable]
	Syslog SnmpAuthenticationFailure [enable disable]
	Syslog RingTopologyChange [enable disable]
	Syslog Port [<port_list>] [disable linkup linkdown both]
	SMTP SystemStart [enable disable]
	SMTP PowerStatus [enable disable]
	SMTP SnmpAuthenticationFailure [enable disable]
	SMTP RingTopologyChange [enable disable]
	SMTP Port [<port_list>] [disable linkup linkdown both]

DHCP Server

DHCP Server>	Mode [enable disable]
--------------	-----------------------

	Setup [<ip_start>] [<ip_end>] [<ip_mask>] [<ip_router>] [<ip_dns>] [<ip_tftp>] [<lease>] [<bootfile>]
--	--

Ring

Ring>	Mode [enable disable]
	Master [enable disable]
	1stRingPort [<port>]
	2ndRingPort [<port>]
	Couple Mode [enable disable]
	Couple Port [<port>]
	Dualhoming Mode [enable disable]
	Dualhoming Port [<port>]

Chain

Chain>	Configuration
	Mode [enable disable]
	1stUplinkPort [<port>]
	2ndUplinkPort [<port>]
	EdgePort [1st 2nd none]

RCS

RCS>	Mode [enable disable]
	Add [<ip_addr>] [<port_list>] [web_on web_off] [telnet_on telnet_off] [snmp_on snmp_off]
	Del <index>
	Configuration

FastRecovery

FastRecovery>	Mode [enable disable]
	Port [<port_list>] [<fr_priority>]

SFP

SFP>	syslog [enable disable]
	temp [<temperature>]
	Info

DeviceBinding

Devicebinding>	Mode [enable disable]
	Port Mode [<port_list>] [disable scan binding shutdown]
	Port DDOS Mode [<port_list>] [enable disable]
	Port DDOS Sensibility [<port_list>] [low normal medium high]
	Port DDOS Packet [<port_list>] [rx_total rx_unicast rx_multicast rx_broadcast tcp udp]
	Port DDOS Low [<port_list>] [<socket_number>]
	Port DDOS High [<port_list>] [<socket_number>]
	Port DDOS Filter [<port_list>] [source destination]
	Port DDOS Action [<port_list>] [do_nothing block_1_min block_10_mins block shutdown only_log reboot_device]
	Port DDOS Status [<port_list>]
	Port Alive Mode [<port_list>] [enable disable]
	Port Alive Action [<port_list>] [do_nothing link_change shutdown only_log reboot_device]
	Port Alive Status [<port_list>]
	Port Stream Mode [<port_list>] [enable disable]
	Port Stream Action [<port_list>] [do_nothing only_log]
	Port Stream Status [<port_list>]
	Port Addr [<port_list>] [<ip_addr>] [<mac_addr>]
	Port Alias [<port_list>] [<ip_addr>]
	Port DeviceType [<port_list>] [unknown ip_cam ip_phone ap pc plc nvr]
	Port Location [<port_list>] [<device_location>]
	Port Description [<port_list>] [<device_description>]

MRP

MRP>	Configuration
	Mode [enable disable]
	Manager [enable disable]
	React [enable disable]
	1stRingPort [<mrp_port>]
	2ndRingPort [<mrp_port>]

	Parameter MRP_TOPchgT [<value>]
	Parameter MRP_TOPNRmax [<value>]
	Parameter MRP_TSTshortT [<value>]
	Parameter MRP_TSTdefaultT [<value>]
	Parameter MRP_TSTNRmax [<value>]
	Parameter MRP_LNKdownT [<value>]
	Parameter MRP_LNKupT [<value>]
	Parameter MRP_LNKNRmax [<value>]

Modbus

Modbus>	Status
	Mode [enable disable]

Technical Specifications

ORing Switch Model	TGS-9120-M12	TGS-9120-M12-BP2
Physical Ports		
10/100/1000Base-T(X) Ports in M12 Auto MDI/MDIX	12 (8-pin A-coding)	12 (8-pin A-coding with 2 x bypass function included)
Technology		
Ethernet Standards	IEEE 802.3 for 10Base-T IEEE 802.3u for 100Base-TX IEEE 802.3ab for 1000Base-T IEEE 802.3x for Flow control IEEE 802.3ad for LACP (Link Aggregation Control Protocol) IEEE 802.1p for COS (Class of Service) IEEE 802.1Q for VLAN Tagging IEEE 802.1w for RSTP (Rapid Spanning Tree Protocol) IEEE 802.1s for MSTP (Multiple Spanning Tree Protocol) IEEE 802.1x for Authentication IEEE 802.1AB for LLDP (Link Layer Discovery Protocol)	
MAC Table	8k	
Priority Queues	8	
Processing	Store-and-Forward	
Switch Properties	Switching latency: 7 us Switching bandwidth: 24Gbps Max. Number of Available VLANs: 256 IGMP multicast groups: 128 for each VLAN Port rate limiting: User Define	
Jumbo frame	Up to 9.6K Bytes	
Security Features	Device Binding security feature Enable/disable ports, MAC based port security Port based network access control (802.1x) VLAN (802.1Q) to segregate and secure network traffic Radius centralized password management SNMPv3 encrypted authentication and access security Https / SSH enhance network security	
Software Features	STP/RSTP/MSTP (IEEE 802.1D/w/s) Redundant Ring (O-Ring) with recovery time less than 30ms over 250 units TOS/Diffserv supported Quality of Service (802.1p) for real-time traffic VLAN (802.1Q) with VLAN tagging and GVRP supported IGMP Snooping IP-based bandwidth management Application-based QoS management DOS/DDOS auto prevention Port configuration, status, statistics, monitoring, security DHCP Server/Client/Relay SMTP Client Modbus TCP	
Network Redundancy	O-Ring Open-Ring O-Chain MRP MSTP (RSTP/STP compatible)	
RS-232 Serial Console Port	RS-232 in 5-pin M12 connector with console cable. 115200bps, 8, N, 1	
LED Indicators		
Power Indicator (PWR)	Green : Power LED x 2	
Ring Master Indicator (R.M.)	Green : Indicates that the system is operating in O-Ring Master mode	
O-Ring Indicator (Ring)	Green : Indicates that the system operating in O-Ring mode Green Blinking : Indicates that the Ring is broken.	
Fault Indicator (Fault)	Amber : Indicate unexpected event occurred	

10/100/1000Base-T(X) M12 Port Indicator	Top Green LED for Link/Act indicator Bottom dual color LED for Ethernet speed indicator : Green LED for 1000Mbps, Amber for 100Mbps, Off for 10Mbps	
Fault contact		
Relay	Relay output to carry capacity of 3A at 24VDC on M12 connector (A-coding)	
Power		
Redundant Input power	Dual DC inputs. 12~48VDC on 5-pin M23 connector	
Power consumption (Typ.)	17.3 Watts	17.8 Watts
Overload current protection	Present	
Reverse Polarity Protection	Present	
Physical Characteristic		
Enclosure	IP-30	
Dimension (W x D x H)	260 (W) x 91.3 (D) x216 (H) mm	
Weight (g)	2196g	2218g
Environmental		
Storage Temperature	-40 to 85°C (-40 to 185°F)	
Operating Temperature	-40 to 75°C (-40 to 158°F)	
Operating Humidity	5% to 95% Non-condensing	
Regulatory Approvals		
EMI	FCC Part 15, CISPR (EN55022) class A, EN50155 (EN50121-3-2, EN55011, EN50121-4)	
EMS	EN61000-4-2 (ESD) EN61000-4-3 (RS), EN61000-4-4 (EFT), EN61000-4-5 (Surge), EN61000-4-6 (CS), EN61000-4-8, EN61000-4-11	
Shock	IEC60068-2-27	
Free Fall	IEC60068-2-32	
Vibration	IEC60068-2-6	
Safety	EN60950-1	
Warranty	5 years	