

**TD-29P**  
**FSK-modem**

**INSTALLATIONSANVISNING**  
**INSTALLATION MANUAL**  
**INSTALLATIONS ANLEITUNG**  
**MANUEL D'INSTALLATION**

**6611-2022**

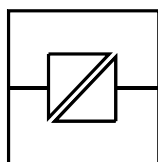

Galvanic  
Isolation

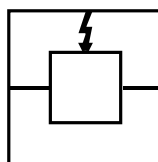

Transient  
Protection

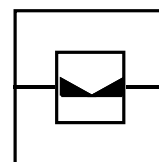

Balanced  
Transmission

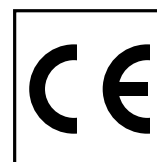

CE  
Approved

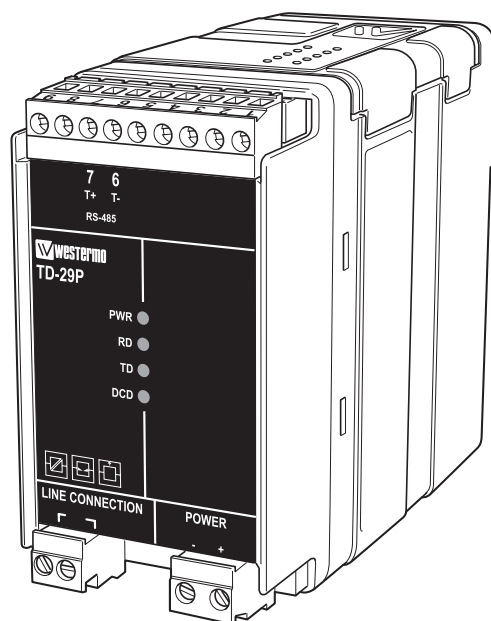

***Multidropp 2-tråd***  
***Multidrop 2-wire***  
***Multidrop 2-Draht***  
***Multipoints 2-fils***

 **westermo**<sup>®</sup>

[www.westermo.com](http://www.westermo.com)

<sup>®</sup>  
**WESTERMO**

# Contents

<b>1. Safety</b> .....	<b>17</b>
<b>2. Approvals</b> .....	<b>17</b>
2.1 Declaration of Conformity .....	<b>18</b>
<b>3. Introduction</b> .....	<b>19</b>
<b>4. Specifications</b> .....	<b>20–21</b>
4.1 Interfaces .....	<b>20</b>
4.2 Isolation between interfaces .....	<b>21</b>
4.3 Environmental .....	<b>21</b>
4.4 Mechanical .....	<b>21</b>
<b>5. Maintenance</b> .....	<b>22</b>
<b>6. Installation</b> .....	<b>22–26</b>
6.1 Mounting / Removal .....	<b>22</b>
6.2 Connections .....	<b>23</b>
6.3 LED Status Indicators .....	<b>23</b>
6.4 RS-485 Interface .....	<b>24</b>
6.5 Line Interface .....	<b>24</b>
6.6 Power Interface .....	<b>24</b>
6.7 Configuration .....	<b>25</b>
6.7.1 DIP switch settings .....	<b>25–26</b>
<b>7. Functional description</b> .....	<b>27–28</b>
7.1 Block diagram .....	<b>27</b>
7.2 RS-485 connection .....	<b>27</b>
7.3 Line connection .....	<b>28</b>

# 1. Safety



## **General:**

Before using this unit, read this manual completely and gather all information on the unit. Make sure that you understand it fully. Check that your application does not exceed the safe operating specifications for this unit.



## **Before installation, maintenance or modification work:**

Prevent damage to internal electronics from electrostatic discharges (ESD) by discharging your body to a grounding point (e.g. use of wrist strap).  
Prevent access to hazardous voltages by disconnecting the unit from AC/DC mains supply and all other electrical connections.



## **Installation:**

This unit should only be installed by qualified personnel.

This unit should only be installed in a “restricted access area”, for example a lockable cabinet where access is restricted to service personnel only.

This unit is intended for permanent connection to the AC/DC mains supply.

The power supply wiring must be sufficiently fused, and if necessary it must be possible to disconnect manually from the AC/DC mains supply. Ensure compliance to national installation regulations.

Units with the rated voltage exceeding 42.4 V peak or 60 VDC, are defined as class I equipment with a protective earthing conductor terminal.

Units with the rated voltage up to 42.4 V peak or 60 VDC, are defined as class III equipment and shall be separated from hazardous voltage by double or reinforced insulation.

This unit uses convection cooling. To avoid obstructing the air flow around the unit, follow the spacing recommendations (see Installation section).

# 2. Approvals

Conformity with the Directive 89/336/EEC Electromagnetic Compatibility (EMC) has been assessed by application of standards EN 61000-6-2 (industrial immunity) EN 61000-6-4 (industrial emission).

## 2.1 Declaration of Conformity



Westermo Teleindustri AB

### Declaration of conformity

The manufacturer Westermo Teleindustri AB  
SE-640 40 Stora Sundby, Sweden

Herewith declares that the product(s)

Type of product	Model	Art no	Installation manual
DIN-rail	TD-29 AC	3611-0101,0104,0110	6611-2001
DIN-rail	TD-29 DC	3611-0001,0003,0004	6611-2001
DIN-rail	TD-29P	3611-0020	6611-2021

is in conformity with the following EC directive(s).

No	Short name
89/336/EEG	Electromagnetic Compatibility (EMC)
73/23/EEG	Low Voltage Directive - LVD

References of standards applied for this EC declaration of conformity.

No	Title	Issue
EN 61000-6-2	Immunity for industrial environments	2 (2001)
EN 55024	Information technology equipment ñ Immunity	1 (1998)
EN 61000-6-3	Emission standard for residential, commercial and light-industrial environments	1 (2001)
EN 60950	Safety of information technology equipment	6 (2000)

The last two digits of the year in which the CE marking was affixed: 03

Herewith declares that product(s) listed above is in conformity with

No	Title	Issue
FCC part 15	Radio frequency devices	

Hans Levin  
Technical Manager  
9th October 2003

Postadress/Postal address  
S-640 40 Stora Sundby  
Sweden

Tel.  
016-428000  
Int+46 16428000

Telefax  
016-428001  
Int+46 16428001

Postgiro  
52 72 79-4

Bankgiro  
5671-5550

Org.nr/  
Corp. identity number  
556361-2604

Registered office  
Eskilstuna

### 3. Introduction

The TD-29P is designed for communication on 2-wire copper cable (twisted pair). Multidrop or point to point half duplex communication is possible at baud rates, 9600 bit/s and 19.2 kbit/s.

The TD-29P is easy to configure for different operating conditions with DIP-switches. Character format, baud rate, transmission level and DCD detection level can be selected. DTE-equipment can be connected through an RS-485 interface. There are two baud rate settings. The maximum bus length in multidrop configuration is dependent on the number of units connected.

**The TD-29P is designed to be used on dedicated lines and is not approved to European standard CTR-15 (2-wire leased line).**

Transmission speed (bit/s)	Range point to point (km)	Signal loss (dB/km)	Loss per unit (multidrop) (dB)
9 600	11	2.1	0,3
19 200	9	2,5	0,4

Measured with Cat.5 cable UTP 4x2x24 AWG. Signal level >-24 dBm. The bus length depends on th line quality.

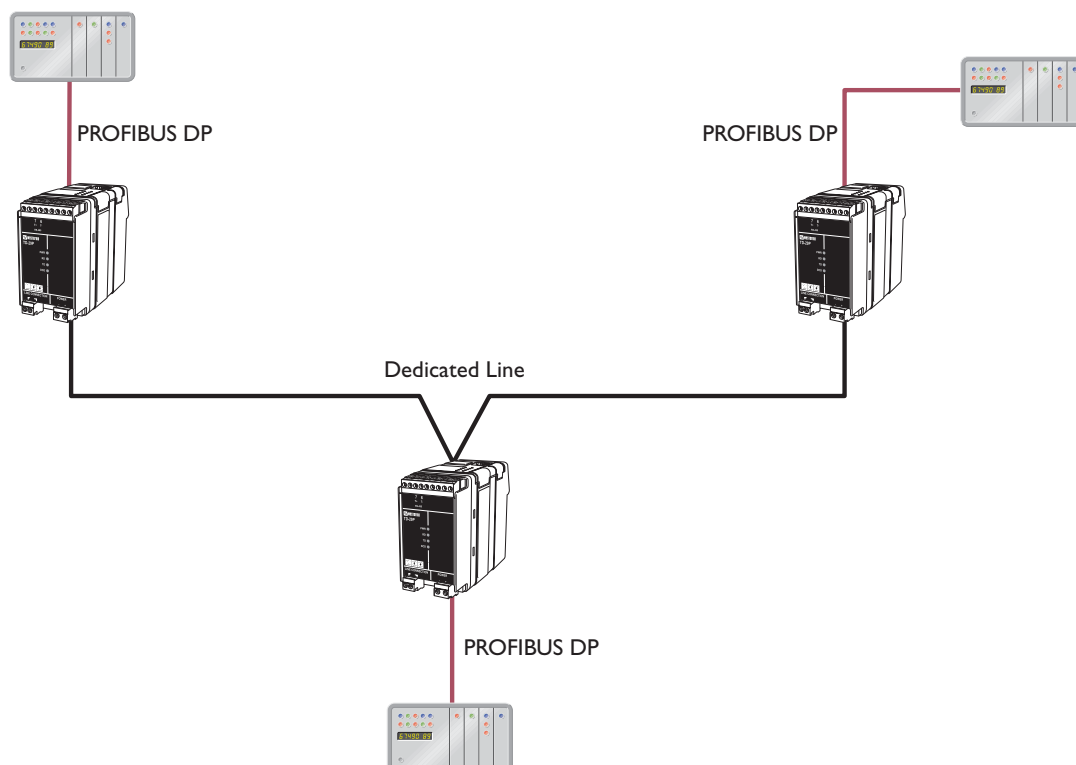

## 4. Specifications

### 4.1 Interfaces

#### Power

	TD-29P DC
Rated voltage	24 VDC
Operating voltage	12–36 VDC
Rated current	200 mA
Rated frequency	DC (Reverse polarity protected)
Connection	2-pos. screw terminal
Connector size	0.2–2.5 mm <sup>2</sup> (AWG 24-12)

#### RS-485

Electrical specification	RS-485
Data rate	9 600 bit/s–19.2 kbit/s
Connection	Screw terminal
Connector size	0.2–2.5 mm <sup>2</sup> (AWG 24-12)
Circuit type	TNV-1

#### FSK-Line

Electrical specification	–
Data rate	9 600 bit/s–19.2 kbit/s
Connection	Screw terminal
Connector size	0.2–2.5 mm <sup>2</sup> (AWG 24-12)
Circuit type	TNV-3

## 4.2 Isolation between interfaces

Power to all other	1.5 kV RMS @ 50Hz and 60 s duration
FSK-Line to all other	1.5 kV RMS @ 50Hz and 60 s duration

## 4.3 Environmental

Temperature, operating	5–50°C
Temperature, storage and transportation	–40 to +85°C
Relative humidity, operating	0 to 95% (non-condensing)
Relative humidity, storage and transportation	0 to 95% (condensation allowed outside packaging)

## 4.4 Mechanical

Dimension (W x H x D)	55 x 100 x 128 mm
Weight	0.5 kg
Mounting	35 mm DIN-rail
Degree of protection	IP 20 (IEC 529)

## 5. Maintenance

No maintenance is required, as long as the unit is used as intended within the specified conditions.

## 6. Installation

### 6.1 Mounting / Removal

#### Before mounting or removing the unit:

Prevent damage to internal electronics from electrostatic discharges (ESD) by discharging your body to a grounding point (e.g. use of wrist strap).

Prevent access to hazardous voltages by disconnecting the unit from AC/DC power supply and all other electrical connections.

#### Mounting

This unit should be mounted on 35 mm DIN-rail which is horizontally mounted on a wall or cabinet backplate.

This unit uses convection cooling. To avoid obstructions to the airflow around the unit, use the following spacing rules. Recommended spacing 25 mm (1.0 inch) above/below and 10 mm (0.4 inches) left/right the unit.

Snap on mounting, see figure

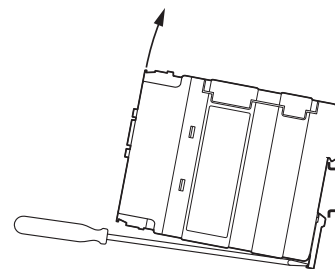
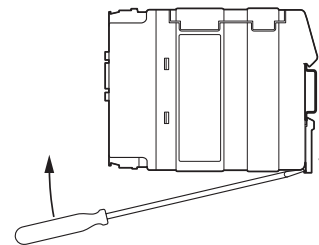
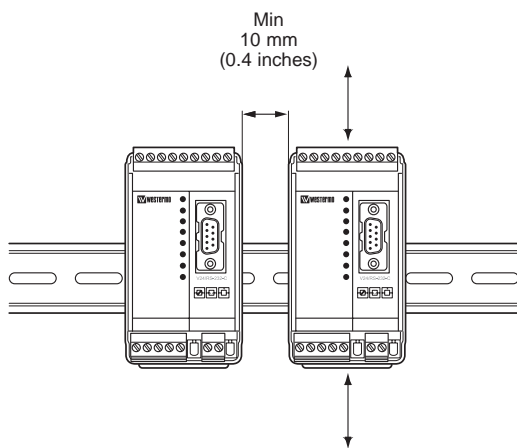
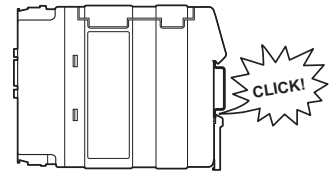
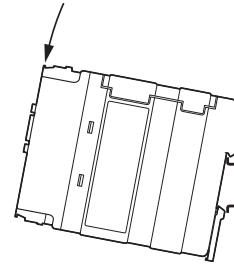

#### Removal

Press down the black support at the back of the unit using a screwdriver, see figure.



## 6.2 Connections

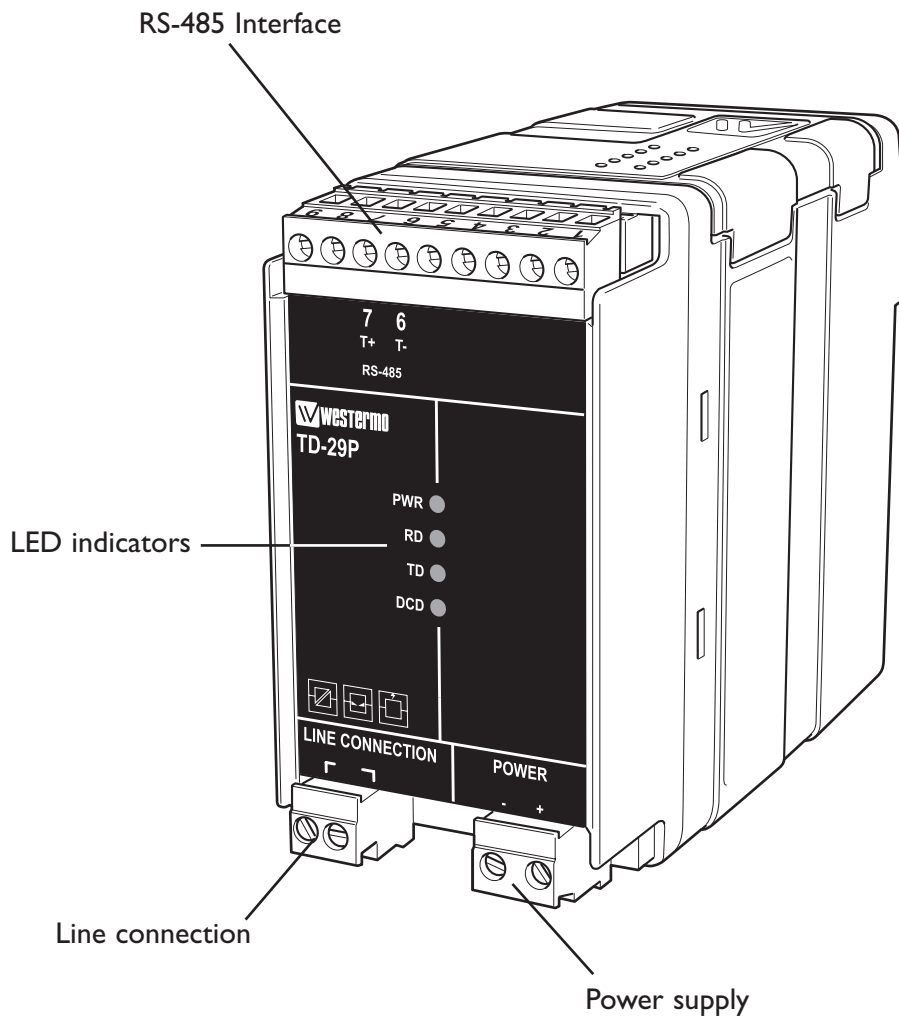

## 6.3 LED Status Indicators

<b>PWR</b>	LED on LED off	Power on Power off
<b>TD</b>	LED on LED off	Transmit line data active Transmit line data inactive
<b>RD</b>	LED on LED off	Receive line data active Receive line data inactive
<b>DCD</b>	LED on LED off	Data Carrier Detect active Data Carrier Detect inactive

## 6.4 RS-485 Interface

9-position Screw terminal	Direction	ITU-TV.11 Description	Description
7	In/Out	A (T+)	Transmitter/Receiver
6	In/Out	B (T-)	Transmitter/Receiver



The definition of R+/R-, T+T- can vary between different manufacturers.

## 6.5 Line Interface

2-position Screw terminal	Direction	Description
1	In/Out	Transmitter/Receiver
2	In/Out	Transmitter/Receiver



## 6.6 Power Interface

Connection	Description	Description
1	-	0VDC
2	+	12-36VDC



## 6.7 Configuration

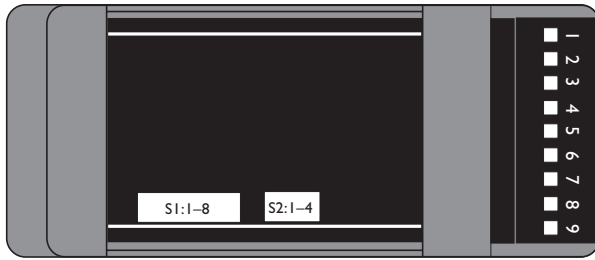

### 6.7.1 DIP switch settings

DIP-switches are accessible under the lid on top of the unit. DIP-switches are used to configure the modem.



#### **Warning!**

Prevent damage to internal electronics from electrostatic discharges (ESD) by discharging your body to a grounding point (e.g. use of wrist strap), before the lid on top of the modem is removed.



#### **Warning! Do not open connected equipment.**

Prevent access to hazardous voltages by disconnecting the unit from AC/DC power supply and all others electrical connections.

#### **NOTE**

When configuring via DIP-switches, the settings of DIP-switches configure the unit only after a power reset. A setting configured by any other method during normal operation, overrides the DIP-switch setting. However, at power up, the DIP-switch settings have precedence over the setting configured by any other method.

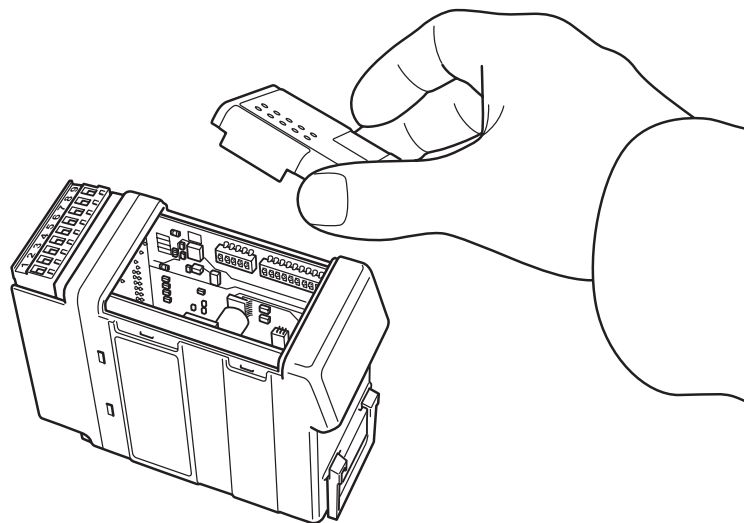

## Switch block 1 – S1

### Character format



### Selection of transmission level\*

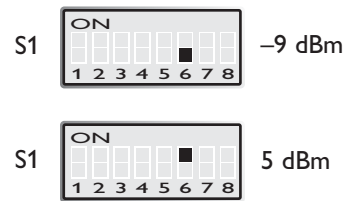

\* Load 600 Ω

### Selection of Baud rate

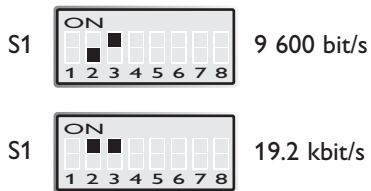

### Selection of minimum detection level

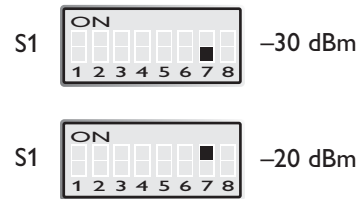

S1: 5 and 8 not used

### Termination of the line\*

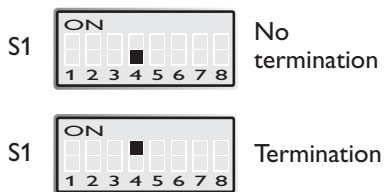

\*The line should be terminated at the end points.

## Switch block 2 – S2

### Termination of RS-485\*



\*The line should be terminated at the end points.

S2: 1 and 2 not used

### Factory setting



# 7. Functional description

## 7.1 Block diagram

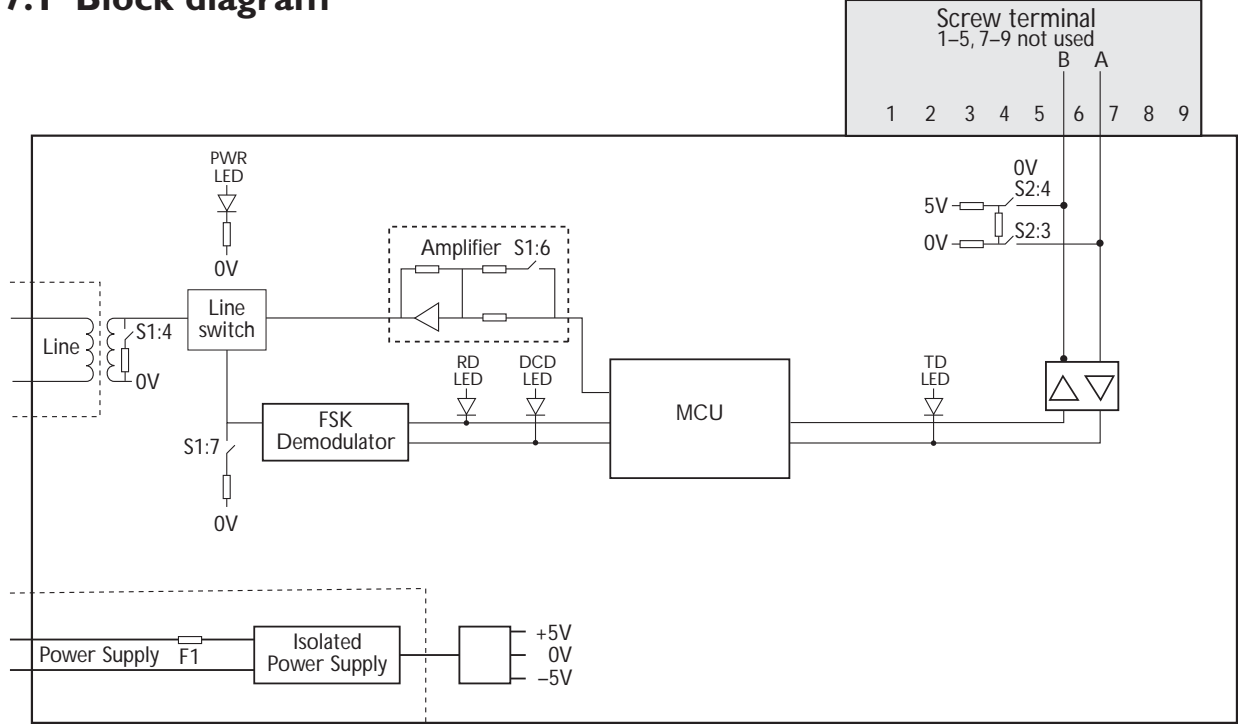

## 7.2 RS-485 connection

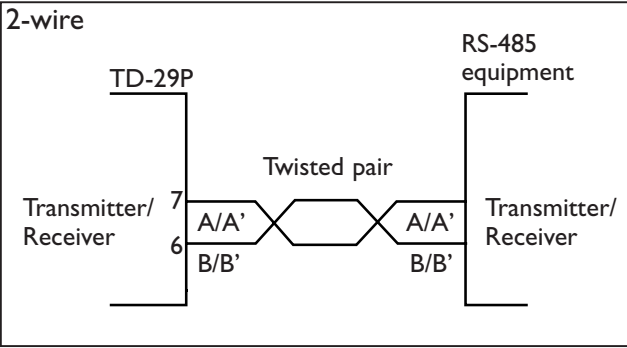

### 7.3 Line connection

2-position  
detachable screw terminal

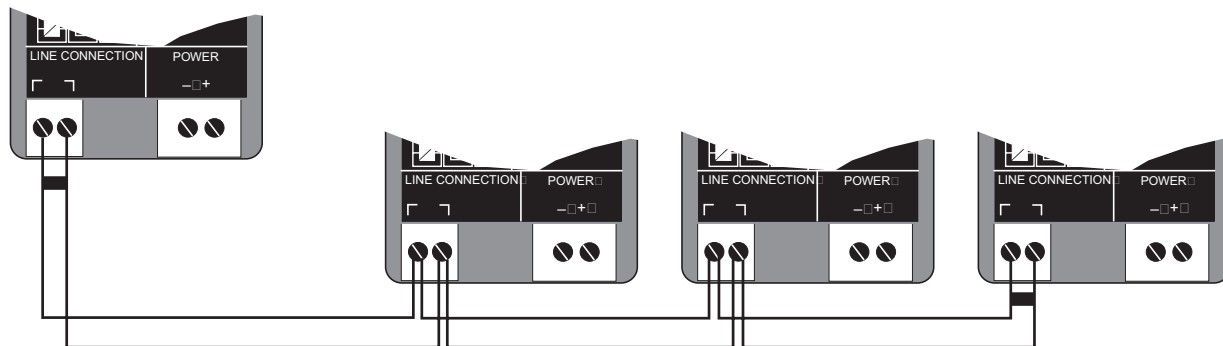

Multidrop half duplex with TD-29P

- Termination to be set with DIP-switches

# OWN COMMENTS

.....

.....

.....

.....

.....

.....

.....

.....

.....

.....

.....

.....

.....

.....

.....

.....

.....

.....

.....

.....

.....

.....

.....

.....



Westermo Teleindustri AB • SE-640 40 Stora Sundby, Sweden

Phone +46 16 42 80 00 Fax +46 16 42 80 01

E-mail: [info@westermo.se](mailto:info@westermo.se)

**Westermo Web site: [www.westermo.com](http://www.westermo.com)**

---

### Subsidiaries

---

Westermo Data Communications Ltd  
Talisman Business Centre • Duncan Road  
Park Gate, Southampton • SO31 7GA  
Phone: +44(0)1489 580 585 • Fax: +44(0)1489 580586  
E-Mail: [sales@westermo.co.uk](mailto:sales@westermo.co.uk)

Westermo Data Communications GmbH  
Goethestraße 67, 68753 Waghäusel  
Tel.: +49(0)7254-95400-0 • Fax: +49(0)7254-95400-9  
E-Mail: [info@westermo.de](mailto:info@westermo.de)

Westermo Data Communications S.A.R.L.  
9 Chemin de Chilly 91160 CHAMPLAN  
Tél : +33 1 69 10 21 00 • Fax : +33 1 69 10 21 01  
E-mail : [infos@westermo.fr](mailto:infos@westermo.fr)

*Westermo Teleindustri AB have distributors in several countries, contact us for further information.*