



## Introduction

With 24VDC power supply, the **TGPS-1080-M12-24V** and **TGPS-1080-M12-BP2-24V** unmanaged Gigabit PoE Ethernet switches are designed for industrial applications, such as rolling stock, vehicle, and railway applications. The switches boast EN50155 compliance and M12 connectors to ensure tight and robust connections, and guarantee reliable operation against environmental disturbances, such as vibration and shock. Both models feature eight 10/100/1000Base-T(X) P.S.E. ports which are able to provide sufficient power for those power-hungry devices with up to 30Watts per port. Therefore, you can attach an IEEE 802.3af-compliant device to the switch without requiring additional power. The **TGPS-1080-M12-BP2-24V** model also provides two sets of bypass ports that ensure constant network connectivity during power failure. Even if the switch loses power, traffic will continue to flow unimpeded through the link.

## Package Contents





The **TGPS-1080-M12-24V**/ **TGPS-1080-M12-BP2-24V** are shipped with the following items. If any of these items is missing or damaged, please contact your customer service representative for assistance.

Contents	Pictures	Number
TGPS-1080-M12-24V or TGPS-1080-M12-BP2-24V		1
QIG		1

## Preparation

Before you begin installing the device, make sure you have all of the package contents available and a PC with Microsoft Internet Explorer 6.0 or later, for using web-based system management tools.

### Safety & Warnings

-  **Elevated Operating Ambient:** If installed in a closed environment, make sure the operating ambient temperature is compatible with the maximum ambient temperature (T<sub>ma</sub>) specified by the manufacturer.
-  **Reduced Air Flow:** Make sure the amount of air flow required for safe operation of the equipment is not compromised during installation.
-  **Mechanical Loading:** Make sure the mounting of the equipment is not in a hazardous condition due to uneven mechanical loading.
-  **Circuit Overloading:** Consideration should be given to the connection of the equipment to the supply circuit and the effect that overloading of the circuits might have on overcurrent protection and supply wiring. Appropriate consideration of equipment nameplate ratings should be used when addressing this concern.

### Dimension

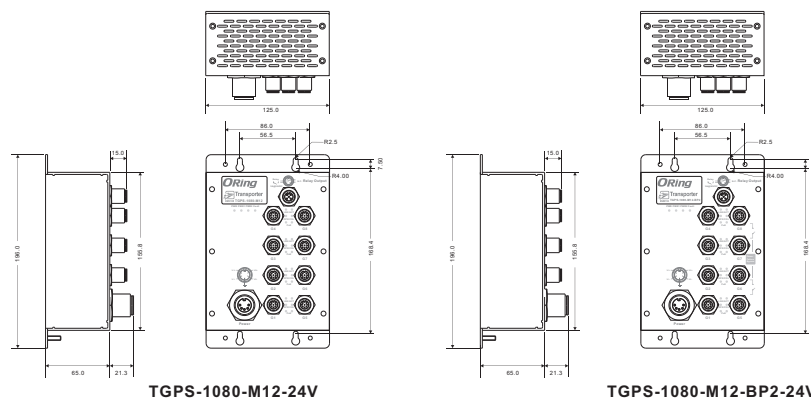

### Panel Layouts

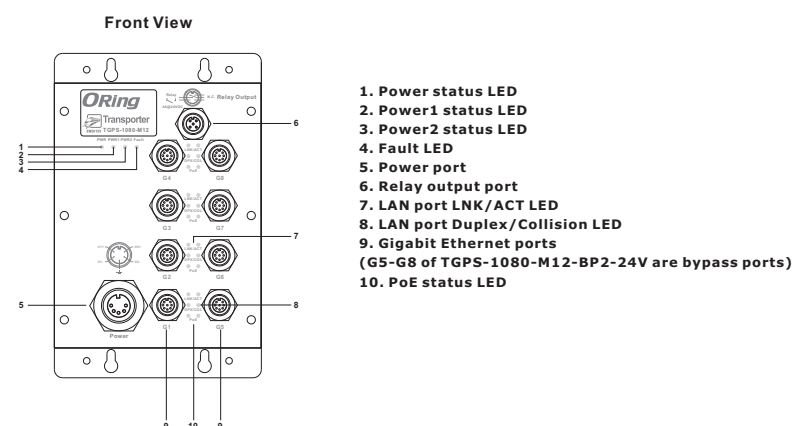

## Installation

### Wall-mount

The device can be fixed to the wall. Follow the steps below to install the device on the wall.  
**Step 1:** Hold the device upright against the wall.  
**Step 2:** Insert four screws through the large opening of the keyhole-shaped apertures at the top and bottom of the unit and fasten the screw to the wall with a screwdriver.  
**Step 3:** Slide the device downwards and tighten the four screws for added stability.

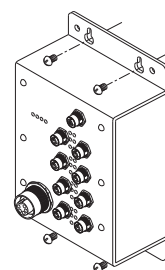

Instead of screwing the screws in all the way, it is advised to leave a space of about 2mm to allow room for sliding the switch between the wall and the screws.

### Wiring

For pin assignments of power, console and relay output ports, please refer to the following tables.

### Grounding

Grounding and wire routing help limit the effects of noise due to electromagnetic interference (EMI). Run the ground connection from the grounding pin on the power connector to the grounding surface prior to connecting devices.

### Power port pinouts

The device supports two sets of power supplies and uses the M23 5-pin female connector on the front panel for the dual power inputs.  
**Step 1:** Insert a power cable to the power connector on the device.  
**Step 2:** Rotate the outer ring of the cable connector until a snug fit is achieved. Make sure the connection is tight.



### Relay output port pinouts

The switch uses the M12 A-coded 5-pin male connector on the front panel for relay output. Use a power cord with an M12 A-coded 5-pin female connector to connect the relay. The relay contacts will detect user-configured events and form an open circuit when an event is triggered.



### Bypass port pinouts

TGPS-1080-M12-BP2-24V includes 2 sets of bypass ports that protect the network from failures by ensuring network integrity during power loss.



### Network Connection

The switch has eight 10/100/1000Base-T(X) Ethernet ports in the form of M12 connector. These ports are PoE-enabled, and thus can deliver power over the same Ethernet cable. Depending on the link type, the switch uses CAT 3, 4, 5, 5e UTP cables to connect to network devices (Pcs, servers, switches, routers, or hubs). Please refer to the following table for cable specifications.

Cable	Type	Max. Length	Connector
10BASE-T	Cat. 3, 4, 5 100-ohm	UTP 100 m (328 ft)	8-pin female M12 A-coding connector
100BASE-TX	Cat. 5 100-ohm UTP	UTP 100 m (328 ft)	8-pin female M12 A-coding connector
1000BASE-T	Cat. 5/Cat. 5e 100-ohm UTP	UTP 100 m (328ft)	8-pin female M12 A-coding connector

### M12/8P Pin Definition

For pin assignments of the LAN ports, please refer to the following tables.



10/100Base-T(X) P.S.E. RJ-45 port	
Pin No.	Description
#1	TD+ with PoE Power input +
#2	TD- with PoE Power input +
#3	RD+ with PoE Power input -
#6	RD- with PoE Power input -

1000Base-T P.S.E. RJ-45 port	
Pin No.	Description
#1	BI_DA- with PoE Power input +
#2	BI_DA- with PoE Power input +
#3	BI_DB+ with PoE Power input -
#4	BI_DC+
#5	BI_DC-
#6	BI_DB- with PoE Power input -
#7	BI_DD+
#8	BI_DD-

## Configurations

After installing the router and connecting cables, start the device by turning on power. The green power LED should turn on. Please refer to the following tablet for LED indication.

LED	Color	Status	Description
Power	Green	On	Power is on
PWR1	Green	On	DC power module 1 activated
PWR2	Green	On	DC power module 2 activated
Fault	Amber	On	Errors occur (power failure)
<b>10/100/1000Base-T(X)</b>			
LNK/ACT	Green (1Gbps)	on	Ethernet links connected
	Amber (10/100Mbps)	Blinking	Transmitting data
Duplex/Collision	Amber	On	Duplex/Collision indicator
PoE	Blue	On	Port providing power to PD

## Specifications

ORing Switch Model	TGPS-1080-M12-24V	TGPS-1080-M12-BP2-24V
<b>Physical Ports</b>		
10/100/1000Base-T(X) Ports in M12 With P.S.E.	8 x M12 connector (8 pin A-coding)	8 x M12 connector (8-pin A-coding, bypass function included on port5~8)
<b>Technology</b>		
Ethernet Standards	IEEE 802.3 for 10Base-T IEEE 802.3u for 100Base-TX IEEE 802.3ab for 1000Base-T IEEE 802.3x for Flow contro IEEE 802.3at compliant PoE specification (total power budget is 120Watts with maximum 30Watts per port)	
MAC Table	2K MAC addresses	
Processing	Store-and-Forward	
<b>LED Indicators</b>		
Power Indicator	Green: Power LED x 3	
Fault Indicator	Amber: Indicate PWR1 or PWR2 failure	
10/100/1000-T(X) RJ45 port indicator and PoE indicator	Top for port Link/Act indicator. Green for 1Gbps link, Amber for 10/100 Mbps link. Middle Amber for Duplex / Collision indicator Bottom Blue for PoE power injected indicator	
<b>Fault Contact</b>		
Relay	Relay output to carry capacity of 3A at 24VDC on M12 connector (5-pin M12 A-coding)	
<b>Power</b>		
Redundant Input Power	Dual DC inputs. 24~36VDC on 5-pin M23 connector	
Power Consumption(Typ.)	11 Watts (power consumption of P.S.E. is not included)	
Overload Current Protection	Present	
Reverse Polarity Protection	Not Present	
<b>Physical Characteristic</b>		
Enclosure	IP-30	
Dimension (W x D x H)	125(W) x 65(D) x 196(H) mm (4.92 x 2.56 x 7.66 inch.)	
Weight (g)	988 g	996 g
<b>Environmental</b>		
Storage Temperature	-40 to 85°C (-40 to 185°F)	
Operating Temperature	-40 to 70°C (-40 to 158°F)	
Operating Humidity	5% to 95% Non-condensing	
<b>Regulatory Approvals</b>		
EMI	FCC Part 15, CISPR (EN55022) class A, EN50155 (EN50121-3-2, EN55011, EN50121-4)	
EMS	EN61000-4-2 (ESD), EN61000-4-3 (RS), EN61000-4-4 (EFT), EN61000-4-5 (Surge), EN61000-4-6 (CS), EN61000-4-8, EN61000-4-11	
Shock	IEC60068-2-27	
Free Fall	IEC60068-2-32	
Vibration	IEC60068-2-6	
Safety	EN60950-1	
Warranty	5 years	

Copyright© 2014 ORing  
All rights reserved.



**ORing Industrial Networking Corp.**

TEL: +886-2-2218-1066

FAX: +886-2-2218-1014

Website: [www.oring-networking.com](http://www.oring-networking.com)

E-mail: [support@oring-networking.com](mailto:support@oring-networking.com)